

IMfinity® 3-phase induction motors - High efficiency & Premium efficiency IP55 aluminium frame

Contents

GENERAL INFORMATION	64-65
Designation.....	64
Description.....	65
ELECTRICAL AND MECHANICAL DATA	66 to 70
IE2 powered by the mains.....	66-67
IE2 powered by the drive.....	68-69
IE3 powered by the mains.....	70-71
IE3 powered by the drive.....	72-73
Mains connection.....	74
DIMENSIONS.....	75 to 80
Shaft extensions	75
Foot mounted IM 1001 (IM B3).....	76
Foot and flange mounted IM 2001 (IM B35).....	77
Flange mounted IM 3001 (IM B5) IM 3011 (IM V1).....	78
Foot and face mounted IM 2101 (IM B34).....	79
Face mounted IM 3601 (IM B14).....	80
CONSTRUCTION.....	81 to 92
Bearings and lubrication	81-82
Axial loads	83 to 85
Radial loads	86 to 92
OPTIONAL FEATURES	93 to 95
Non-standard flanges	93
Mechanical options.....	94
Mechanical and electrical options	95
INSTALLATION AND MAINTENANCE.....	96
Position of the lifting rings	96

IMfinity® 3-phase induction motors - High efficiency & Premium efficiency

IP55 aluminium frame

General information

Description

IP55 ALUMINIUM MOTORS



IP 55
Cl. F - ΔT 80 K

The complete motor **reference** described below will enable you to order the desired **equipment**.

The selection method consists of following the terms in the designation.

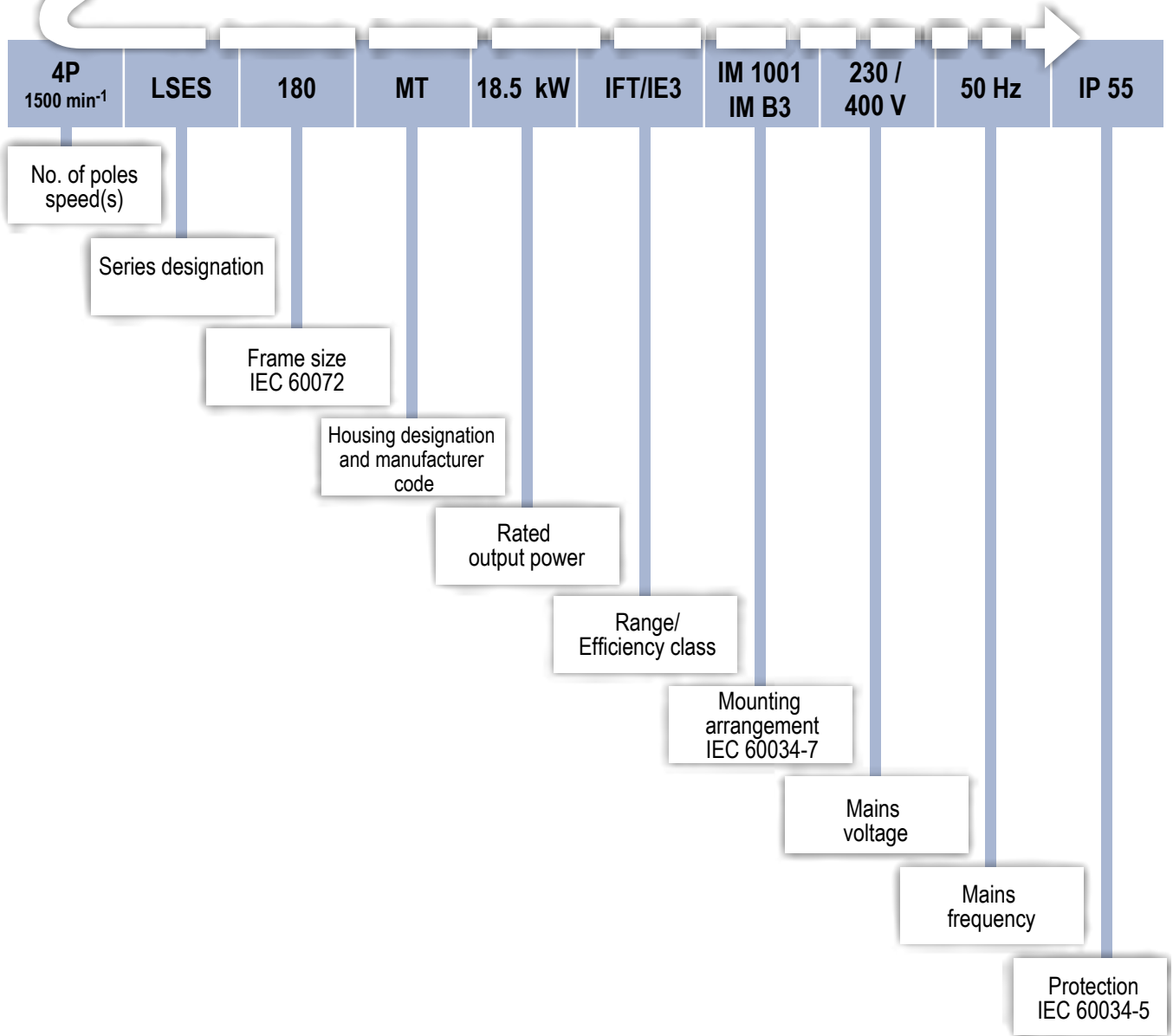

IMfinity® 3-phase induction motors - High efficiency & Premium efficiency

IP55 aluminium frame

General information

Description

Component	Materials	Remarks
Housing with cooling fins	Aluminium alloy	<ul style="list-style-type: none"> - with integral or screw-on feet, or without feet - 4 or 6 fixing holes for housings with feet - lifting rings for frame size \geq 100 - earth terminal with an optional jumper screw
Stator	Insulated low-carbon magnetic steel laminations Electroplated copper	<ul style="list-style-type: none"> - low carbon content guarantees long-term lamination pack stability - semi-enclosed slots - class F insulation
Rotor	Insulated low-carbon magnetic steel laminations Aluminium	<ul style="list-style-type: none"> - inclined cage bars - rotor cage pressure die-cast in aluminium (or alloy for special applications) - shrink-fitted to shaft - rotor balanced dynamically, 1/2 key
Shaft	Steel	<ul style="list-style-type: none"> - for frame size \leq 160 MP - LR: <ul style="list-style-type: none"> • tapped hole • closed keyway - for frame size \geq 160 M - L: <ul style="list-style-type: none"> • tapped hole • open keyway
End shields	Aluminium alloy	- 80 - 90 NDE shield
	Cast iron	- 80 - 90 DE shield (except for 6-pole version and optional for 80 and 90 NDE shield) - 100 to 315 DE shield and NDE shield
Bearings and lubrication		<ul style="list-style-type: none"> - permanently greased bearings frame size 80 to 225 - regreasable bearings frame size 250 to 315 - bearings preloaded at non drive end
Labyrinth seal Lipseals	Plastic or steel Synthetic rubber	<ul style="list-style-type: none"> - lipseal or deflector at drive end for all flange mounted motors - lipseal, deflector or labyrinth seal for foot mounted motors
Fan	Composite material or aluminium alloy	- 2 directions of rotation: straight blades
Fan cover	Composite material or pressed steel	- fitted, on request, with a drip cover for operation in vertical position, shaft end facing down (steel cover)
Terminal box	Composite material or aluminium alloy	<ul style="list-style-type: none"> - IP 55 - can be turned, opposite the feet - fitted with a terminal block with 6 steel terminals as standard (brass as an option) - terminal box fitted with threaded plugs, supplied without cable glands (cable glands as an option) - 1 earth terminal in each terminal box - fixing system consisting of a cover with captive screws

In the standard version, the motors are wound 400 V 50 Hz:

- power ratings \leq 5.5 kW: Y connection
- power ratings \geq 7.5 kW: connection Δ

IMfinity® 3-phase induction motors - High efficiency & Premium efficiency

IP55 aluminium frame

Electrical and mechanical characteristics

IE2 powered by the mains

Type	Rated power P _n kW	Rated torque M _n N.m	Starting torque/ Rated torque M _d /M _n	Maximum torque/ Rated torque M _m /M _n	Starting current/ Rated current I _d /I _n	Moment of inertia J kg.m ²	Weight IM B3 kg	Noise LP db(A)	400 V 50 Hz							
									Rated speed N _n min ⁻¹	Rated current I _n A	Efficiency IEC 60034-2-1 2007 η			Power factor Cos φ		
											4/4	3/4	2/4	4/4	3/4	2/4
2 poles																
LSES 80 L	0.75	2.5	3.0	3.2	6.4	0.00084	9.7	56	2850	1.6	79.5	80.4	78.9	0.85	0.78	0.66
LSES 80 L	1.1	3.7	2.5	3.1	6.7	0.00095	9.9	57	2850	2.3	80.7	82.0	81.0	0.85	0.78	0.65
LSES 90 SL	1.5	5	2.2	2.9	6.4	0.00201	14.4	63	2865	3	83.7	85.8	86.1	0.86	0.80	0.68
LSES 90 L	1.8	6	3.0	3.1	6.9	0.00223	15.6	63	2885	3.9	83.4	84.8	84.6	0.84	0.78	0.66
LSES 90 L	2.2	7.4	2.7	2.9	6.2	0.00223	15.6	64	2860	4.4	83.7	85.8	86.1	0.86	0.80	0.68
LSES 100 L	3	10	4.4	3.9	8.0	0.00297	21.5	67	2855	5.9	85.3	86.4	85.7	0.86	0.79	0.67
LSES 100 L	3.7	12.3	3.0	3.2	7.2	0.00364	35.2	67	2875	7.15	85.8	87.4	87.7	0.87	0.82	0.71
LSES 112 M	4	13.3	3.4	3.0	7.4	0.00364	24.4	66	2875	7.85	86.1	87.7	87.7	0.85	0.79	0.67
LSES 132 S	5.5	18	2.4	3.2	7.7	0.00967	35.6	72	2920	10.5	87.7	88.5	87.7	0.86	0.81	0.70
LSES 132 SU	7.5	24.5	2.5	3.3	7.8	0.01207	42.7	71	2920	14.3	88.5	89.4	89.1	0.86	0.81	0.70
LSES 132 M	9	29.3	2.1	2.9	6.6	0.01102	55.5	67	2930	16.8	90.2	91.3	91.4	0.86	0.82	0.73
LSES 160 MP	11	35.8	2.4	3.1	6.9	0.01263	65	71	2935	21.1	90.4	91.1	90.7	0.83	0.77	0.67
LSES 160 MR	15	48.8	2.4	3.2	7.3	0.01506	76.1	73	2935	28.2	90.6	91.3	91.0	0.85	0.80	0.70
LSES 160 L	18.5	60	2.7	3.0	8.2	0.049	100	69	2945	32.8	92.3	93.1	93.2	0.88	0.85	0.77
LSES 180 MT	22	71.6	2.6	2.6	7.4	0.0554	100	68	2935	39.4	92.0	93.0	93.3	0.88	0.85	0.78
LSES 200 LR	30	97.1	3.1	3.6	8.5	0.0929	158	74	2950	54.4	93.0	93.4	93.1	0.86	0.82	0.74
LSES 200 L	37	120	2.0	2.8	6.6	0.2492	198	74	2940	66.4	93.3	93.9	93.9	0.86	0.83	0.76
LSES 225 MT	45	146	2.3	3.3	7.3	0.1389	200	73	2945	81.7	93.5	94.1	94.1	0.85	0.81	0.73
LSES 250 MZ	55	178	2.5	3.5	8.0	0.1754	234	72	2945	96.1	94.0	94.6	94.6	0.88	0.85	0.79
LSES 280 SC	75	241	2.3	3.3	8.0	0.4092	350	79	2970	127	94.4	94.6	94.3	0.90	0.88	0.82
LSES 280 MC	90	289	2.5	3.6	8.4	0.476	382	80	2972	152	94.7	95.0	94.7	0.90	0.88	0.82
LSES 315 SN	110	354	2.6	3.1	8.0	0.5343	452	79	2968	186	95.0	95.4	95.3	0.90	0.88	0.84
LSES 315 MP	132	423	2.3	3.2	7.7	0.5784	470	79	2978	228	95.2	95.2	94.6	0.88	0.86	0.80
LSES 315 MP	160	513	2.2	3.3	7.7	1.2646	705	80	2978	275	95.4	95.5	93.9	0.88	0.86	0.80
LSES 315 MP	200	642	2.2	3.5	7.8	1.3841	770	80	2974	342	95.6	95.8	95.5	0.88	0.86	0.80
4 poles																
LSES 80 LG	0.75	5	1.9	2.8	5.9	0.00265	11.6	47	1445	1.7	80.9	81.5	80.1	0.78	0.70	0.57
LSES 80 LG	0.9	6	1.9	2.5	6.3	0.00316	14.1	47	1435	1.95	80.5	81.5	79.8	0.82	0.60	0.74
LSES 90 SL	1.1	7.3	1.9	2.7	6.1	0.00336	13.9	47	1440	2.35	82.1	83.8	83.5	0.82	0.74	0.61
LSES 90 L	1.5	10	2.3	2.9	6.3	0.00418	16.2	47	1440	3.15	83.5	85.1	84.7	0.82	0.75	0.62
LSES 90 LU	1.8	11.9	2.6	2.3	6.6	0.0045	20.4	47	1440	3.8	83.9	84.4	82.8	0.81	0.72	0.57
LSES 100 L	2.2	14.6	2.5	3.1	6.8	0.00567	22.6	49	1440	4.5	85.0	86.3	85.9	0.83	0.76	0.64
LSES 100 LR	3	19.9	2.8	3.2	6.7	0.00677	25.8	54	1440	6.25	85.8	87.1	86.8	0.81	0.73	0.60
LSES 112 MU	4	26.4	2.2	3.0	6.2	0.01312	34.4	55	1445	7.9	87.2	88.9	89.3	0.84	0.78	0.67
LSES 132 SU	5.5	36.1	2.7	3.1	7.1	0.01611	42.1	55	1454	11.2	88.5	89.5	89.2	0.80	0.73	0.60
LSES 132 M	7.5	49.3	2.6	3.4	7.5	0.02286	52.1	60	1452	14.4	89.4	90.5	90.5	0.84	0.78	0.66
LSES 132 M	9	58.9	2.8	3.6	8.0	0.02722	59.1	63	1458	17.1	90.0	91.0	91.0	0.84	0.78	0.66
LSES 160 MR	11	71.9	3.1	3.7	8.4	0.03574	78	61	1460	20.9	90.6	91.5	91.3	0.84	0.78	0.66
LSES 160 L	15	97.8	2.5	3.1	8.1	0.0712	90	60	1464	28.2	91.2	92.1	92.1	0.84	0.79	0.67
LSES 180 MT	18.5	121	2.1	3.2	8.2	0.0844	100	58	1464	35.2	91.4	92.3	92.2	0.83	0.77	0.66
LSES 180 LR	22	143	2.6	3.4	8.6	0.0956	108	60	1466	41	91.9	92.7	92.6	0.84	0.79	0.68
LSES 200 LR	30	196	2.0	2.6	7.8	0.1563	166	64	1464	56.3	92.4	93.3	93.4	0.83	0.78	0.69
LSES 225 ST	37	240	2.7	2.7	6.3	0.2294	205	64	1472	70.2	92.9	93.7	93.8	0.82	0.77	0.67
LSES 225 MR	45	292	2.3	2.4	6.9	0.2885	230	70	1472	83.8	93.4	94.1	94.0	0.83	0.78	0.68
LSES 250 ME	55	354	2.3	2.7	7.3	0.7793	350	69	1484	101	94.7	95.1	95.0	0.83	0.79	0.70
LSES 280 SD	75	482	2.5	3.2	8.2	0.9595	428	69	1486	138	94.5	94.7	94.4	0.83	0.79	0.69
LSES 280 MD	90	579	2.6	3.5	8.3	1.0799	470	68	1484	169	94.7	94.9	94.6	0.81	0.76	0.65
LSES 315 SP	110	706	3.1	2.9	7.6	2.4322	690	76	1488	200	94.8	94.8	94.3	0.84	0.80	0.70
LSES 315 MP	132	848	3.1	2.8	7.3	3.223	740	76	1486	236	95.0	95.2	94.8	0.85	0.81	0.72
LSES 315 MP	160	1030	2.6	2.8	7.2	3.223	740	76	1486	293	95.0	95.1	94.6	0.83	0.78	0.68
LSES 315 MR	200	1290	3.0	2.9	7.3	3.2324	820	76	1486	366	95.5	95.7	95.3	0.83	0.78	0.68
6 poles																
LSES 90 SL	0.75	7.5	1.9	2.4	4.1	0.00338	14.8	43	952	2.05	76.6	76.7	73.6	0.68	0.58	0.46
LSES 90 L	1.1	11.2	1.9	2.3	4.3	0.00437	17.8	53	940	2.8	79.2	80.7	79.7	0.71	0.62	0.49
LSES 100 L	1.5	15.2	2.0	2.4	4.3	0.00602	24.8	53	945	3.9	80.6	81.8	80.6	0.69	0.60	0.47
LSES 112 MG	2.2	21.9	2.1	2.4	5.0	0.01523	30.4	50	960	5.3	82.0	83.2	82.3	0.73	0.65	0.52
LSES 132 S	3	29.8	2.4	2.7	5.3	0.01922	38.4	49	960	7.3	83.4	84.5	83.5	0.71	0.63	0.50
LSES 132 M	4	39.6	2.2	2.6	5.6	0.02528	47.7	53	964	8.8	85.5	86.9	86.8	0.77	0.71	0.59
LSES 132 M	5.5	54.4	2.6	2.8	5.8	0.03027	54	53	966	12.6	86.2	87.3	86.8	0.73	0.66	0.53
LSES 160 M	7.5	73.5	1.7	2.7	5.4	0.0912	82	59	974	16.6	87.9	88.1	86.4	0.74	0.66	0.53
LSES 160 LUR	11	108	1.9	2.7	5.9	0.1378	105	57	974	23.7	89.2	89.5	88.3	0.75	0.68	0.55
LSES 180 L	15	147	2.6	2.9	7.3	0.2048	140	62	976	29.6	90.0	90.9	90.7	0.81	0.76	0.65
LSES 200 LR	18.5	181	2.6	2.9	6.9	0.2538	165	62	974	36.7	90.8	91.8	91.9	0.80	0.75	0.64
LSES 200 L	22	216	1.8	2.5	6.1	0.33	200	62	974	42.5	91.1	92.2	92.5	0.82	0.79	0.70
LSES 225 MR	30	293	2.9	3.2	7.6	0.3915	222	65	978	62.7	92.0	92.4	91.8	0.75	0.70	0.59
LSES 250 ME	37	360	2.2	2.4	6.1	0.9234	310	64	982	68	92.5	93.0	92.9	0.85	0.81	0.72
LSES 280 SC	45	438	2.2	2.5	6.2	1.1279	377	64	982	84.3	92.9	93.5	93.3	0.83	0.78	0.68
LSES 280 MC	55	534	2.4	2.7	6.5	1.3995	444	59	984	103	93.3	93.8	93.6	0.83	0.79	0.68
LSES 315 SP	75	723	3.0	2.6	7.4	2.8937	630	71	990	148	94.0	94.1	93.3	0.78	0.73	0.61
LSES 315 MP	90	868	3.1	2.7	7.8	3.4127	700	75	990	172	94.5	94.5	93.7	0.80	0.75	0.64
LSES 315 MR	110	1060	3.0	2.1	7.4	3.0776	770	73	990	209	94.8	95.0	94.5	0.80	0.76	0.66
LSES 315 MR	132	1270	2.7	2.2	7.1	4.6331	860	76	990	252	95.0	95.2	94.8	0.80	0.76	0.66

IMfinity® 3-phase induction motors - High efficiency & Premium efficiency IP55 aluminium frame

Electrical and mechanical characteristics

IE2 powered by the mains

Type	Rated power P_n kW	380 V 50 Hz				415 V 50 Hz				460 V 60 Hz			
		Rated speed N_n min ⁻¹	Rated current I_n A	Efficiency η 4/4	Power factor $\cos \phi$ 4/4	Rated speed N_n min ⁻¹	Rated current I_n A	Efficiency η 4/4	Power factor $\cos \phi$ 4/4	Rated speed N_n min ⁻¹	Rated current I_n A	Efficiency η 4/4	Power factor $\cos \phi$ 4/4
2 poles													
LSES 80 L	0.75	2830	1.65	78.7	0.87	2865	1.6	79.6	0.83	3475	1.4	80.9	0.82
LSES 80 L	1.1	2825	2.4	79.6	0.87	2865	2.3	81.0	0.83	3475	2	83.2	0.83
LSES 90 SL	1.5	2825	4.55	83.2	0.88	2870	4.3	84.6	0.84	3485	3.8	86.5	0.84
LSES 90 L	1.8	2865	4.05	82.3	0.87	2900	3.85	83.9	0.81	3495	3.2	84.4	0.84
LSES 90 L	2.2	2825	4.55	83.2	0.88	2870	4.3	84.6	0.84	3485	3.8	86.5	0.84
LSES 100 L	3	2830	6.15	84.6	0.88	2875	5.85	85.8	0.83	3485	5.15	86.8	0.84
LSES 100 L	3.7	2860	7.55	85.5	0.88	2890	7.05	86.6	0.84	3500	6.3	86.6	0.85
LSES 112 M	4	2850	8.05	85.8	0.87	2885	7.75	86.6	0.83	3500	6.8	88.1	0.83
LSES 132 S	5.5	2905	10.8	87.0	0.88	2930	10.4	87.9	0.83	3535	9.15	88.8	0.85
LSES 132 SU	7.5	2905	14.6	88.1	0.88	2925	14.1	88.7	0.83	3535	12.4	89.6	0.85
LSES 132 M	9	2920	17.6	89.4	0.87	2940	16.5	90.6	0.84	3540	14.6	91.4	0.85
LSES 160 MP	11	2930	21.8	90.0	0.85	2945	21.1	90.6	0.80	3550	18.3	91.5	0.83
LSES 160 MR	15	2920	29	90.3	0.87	2935	28	90.7	0.82	3545	24.4	91.4	0.85
LSES 160 L	18.5	2935	34.4	91.6	0.89	2950	32.2	92.6	0.86	3554	28.5	93.2	0.88
LSES 180 MT	22	2925	41.1	91.3	0.89	2945	38.3	92.5	0.87	3545	33.8	93.3	0.87
LSES 200 LR	30	2945	56.2	92.5	0.88	2954	53.1	93.2	0.84	3558	47.1	93.3	0.86
LSES 200 L	37	2925	69.1	92.5	0.87	2945	65.5	93.3	0.84	3552	57.7	93.5	0.86
LSES 225 MT	45	2935	84.7	93.0	0.87	2950	80.2	93.6	0.83	3558	70.7	94.2	0.85
LSES 250 MZ	55	2940	100	93.4	0.89	2954	93.9	94.2	0.87	3560	83.1	94.6	0.88
LSES 280 SC	75	2964	134	94.0	0.91	2974	124	94.6	0.89	3574	111	94.4	0.90
LSES 280 MC	90	2968	159	94.5	0.91	2972	149	94.8	0.89	3574	132	94.8	0.90
LSES 315 SN	110	2962	196	94.6	0.91	2970	180	95.1	0.89	3574	162	95.2	0.90
LSES 315 MP	132	2974	238	95.0	0.89	2984	221	95.3	0.87	3580	199	95.0	0.88
LSES 315 MP	160	2976	287	95.2	0.89	2980	268	95.5	0.87	3580	240	95.2	0.88
LSES 315 MP	200	2970	359	95.4	0.89	2980	336	95.7	0.86	3580	298	95.7	0.88
4 poles													
LSES 80 LG	0.75	1435	1.75	79.7	0.82	1450	1.7	80.77	0.76	1754	1.5	82.9	0.75
LSES 80 LG	0.9	1430	2.05	80.3	0.84	1440	1.95	80.70	0.80	1750	1.75	82.5	0.79
LSES 90 SL	1.1	1430	2.45	81.4	0.84	1445	2.35	82.53	0.80	1750	2.05	84.9	0.79
LSES 90 L	1.5	1430	3.25	82.8	0.85	1445	3.1	84.09	0.80	1752	2.75	86.2	0.79
LSES 90 LU	1.8	1435	3.95	82.8	0.84	1445	3.75	84.10	0.79	1756	3.3	86.8	0.79
LSES 100 L	2.2	1435	4.65	84.3	0.85	1450	4.45	85.56	0.81	1754	3.95	87.5	0.80
LSES 100 LR	3	1430	6.35	85.5	0.84	1445	6.2	86.07	0.78	1752	5.45	87.9	0.78
LSES 112 MU	4	1435	8.3	86.6	0.85	1450	7.75	87.74	0.82	1756	6.8	89.7	0.82
LSES 132 SU	5.5	1445	11.4	87.9	0.83	1458	11.2	88.62	0.77	1762	9.75	90.5	0.78
LSES 132 M	7.5	1445	14.8	88.7	0.86	1458	14.3	89.66	0.81	1762	12.6	91.1	0.82
LSES 132 M	9	1450	17.7	89.4	0.87	1460	16.9	90.30	0.82	1764	15	91.6	0.83
LSES 160 MR	11	1452	21.5	89.9	0.87	1462	20.6	90.82	0.82	1766	18.3	91.7	0.83
LSES 160 L	15	1460	29.1	90.6	0.86	1468	27.8	91.50	0.82	1772	24.6	92.8	0.83
LSES 180 MT	18.5	1460	36	91.2	0.86	1468	34.9	91.59	0.81	1770	30.5	93.0	0.82
LSES 180 LR	22	1460	42	91.6	0.87	1468	40.8	91.92	0.81	1772	35.6	93.2	0.83
LSES 200 LR	30	1458	57.9	92.3	0.85	1468	55.6	92.72	0.81	1772	48.9	93.7	0.82
LSES 225 ST	37	1472	72.2	92.7	0.84	1478	65.3	93.00	0.80	1782	60.8	94.1	0.81
LSES 225 MR	45	1466	86.2	93.1	0.85	1474	78.4	93.57	0.81	1776	72.5	94.4	0.82
LSES 250 ME	55	1482	105	94.3	0.84	1486	98.5	94.93	0.82	1786	88	95.2	0.82
LSES 280 SD	75	1484	143	94.1	0.85	1486	135	94.64	0.81	1786	121	94.9	0.82
LSES 280 MD	90	1482	174	94.5	0.83	1488	167	94.70	0.79	1788	149	95.1	0.80
LSES 315 SP	110	1486	207	94.6	0.85	1488	194	95.03	0.82	1790	177	94.5	0.83
LSES 315 MP	132	1484	244	94.7	0.86	1488	230	95.00	0.84	1790	207	95.0	0.84
LSES 315 MP	160	1484	301	94.9	0.85	1488	292	94.89	0.81	1790	256	95.2	0.82
LSES 315 MR	200	1484	375	95.1	0.85	1488	360	95.41	0.81	1790	318	95.8	0.82
6 poles													
LSES 90 SL	0.75	945	2.05	76.1	0.72	956	2.1	76.2	0.65	-	-	-	-
LSES 90 L	1.1	930	2.85	78.1	0.74	945	2.85	79.5	0.68	-	-	-	-
LSES 100 L	1.5	930	3.95	79.8	0.73	950	3.9	80.7	0.66	-	-	-	-
LSES 112 MG	2.2	952	5.45	81.8	0.75	962	5.3	82.2	0.71	-	-	-	-
LSES 132 S	3	954	7.4	83.3	0.74	964	7.35	83.7	0.68	-	-	-	-
LSES 132 M	4	956	9.05	84.6	0.80	966	8.7	85.8	0.75	-	-	-	-
LSES 132 M	5.5	960	12.9	86.0	0.75	970	13	86.5	0.68	-	-	-	-
LSES 160 M	7.5	970	16.7	87.6	0.78	976	16.8	87.7	0.71	-	-	-	-
LSES 160 LUR	11	972	24.2	88.9	0.78	976	23.6	89.2	0.73	-	-	-	-
LSES 180 L	15	972	30.7	89.7	0.83	978	29.2	90.3	0.79	-	-	-	-
LSES 200 LR	18.5	968	38.2	90.4	0.82	976	35.9	91.2	0.78	-	-	-	-
LSES 200 L	22	968	44.1	90.9	0.83	976	41.2	91.6	0.81	-	-	-	-
LSES 225 MR	30	970	61.4	91.7	0.81	982	59.3	91.9	0.72	-	-	-	-
LSES 250 ME	37	984	70.3	92.2	0.86	988	68.1	92.7	0.82	-	-	-	-
LSES 280 SC	45	982	86.9	92.7	0.85	984	83.5	93.1	0.80	-	-	-	-
LSES 280 MC	55	980	105	93.1	0.85	986	101	93.2	0.81	-	-	-	-
LSES 315 SP	75	990	151	93.9	0.80	992	146	94.3	0.76	-	-	-	-
LSES 315 MP	90	990	178	94.3	0.82	992	170	94.4	0.78	-	-	-	-
LSES 315 MR	110	988	216	94.5	0.82	992	205	95.1	0.78	-	-	-	-
LSES 315 MR	132	990	261	94.8	0.81	990	247	95.0	0.78	-	-	-	-

IMfinity® 3-phase induction motors - High efficiency & Premium efficiency

IP55 aluminium frame

Electrical and mechanical characteristics

IE2 powered by the drive

IP55 ALUMINIUM MOTORS

Type	400 V 50 Hz				% Rated torque M _n at					400 V 87 Hz Δ ¹				Speed mechanical maximum ²
	Rated power	Rated speed	Rated current	Power factor	10 Hz	17 Hz	25 Hz	50 Hz	87 Hz	Rated power	Rated speed	Rated current	Power factor	
	P _n kW	N _n min ⁻¹	I _n A	Cos φ 4/4						P _n kW	N _n min ⁻¹	I _n A	Cos φ 4/4	
2 poles														
LSES 80 L	0.75	2800	1.65	0.85	90%	100%	100%	100%	57%	1.31	5020	2.88	0.85	13500
LSES 80 L	1.1	2785	2.5	0.85	85%	100%	100%	100%	57%	1.91	5005	4.32	0.85	13500
LSES 90 SL	1.5	2800	3.2	0.87	85%	100%	100%	100%	57%	2.61	5020	5.59	0.87	11700
LSES 90 L	1.8	2900	3.9	0.84	85%	100%	100%	100%	57%	3.13	5085	6.86	0.84	11700
LSES 90 L	2.2	2775	4.8	0.86	85%	100%	100%	100%	57%	3.83	4995	8.38	0.86	11700
LSES 100 L	3	2790	6.2	0.86	85%	100%	100%	100%	57%	5.22	5010	10.84	0.86	9900
LSES 100 L	3.7	2905	7.15	0.87	85%	100%	100%	100%	57%	6.64	5070	13.37	0.87	9900
LSES 112 M	4	2810	8.3	0.85	85%	100%	100%	100%	57%	6.96	5030	14.47	0.85	9900
LSES 132 S	5.5	2890	11.1	0.86	85%	100%	100%	100%	57%	9.57	5110	19.3	0.86	7600
LSES 132 SU	7.5	2885	15.1	0.86	85%	95%	100%	100%	57%	13.05	5105	26.24	0.86	7600
LSES 132 M	9	2900	17.8	0.86	85%	95%	100%	100%	57%	15.66	5120	30.98	0.86	6700
LSES 160 MP	11	2915	21.9	0.83	85%	95%	100%	100%	57%	19.14	5135	38.09	0.83	6700
LSES 160 MR	15	2900	29.7	0.85	85%	95%	100%	100%	57%	26.1	5120	51.64	0.85	6700
LSES 160 L	18.5	2920	35.6	0.88	85%	95%	100%	100%	57%	32.19	5140	61.96	0.88	6030
LSES 180 MT	21.1	2905	40.8	0.88	82%	91%	96%	96%	55%	36.77	5125	71.06	0.88	5670
LSES 200 LR	30	2930	57.1	0.86	85%	90%	100%	100%	-	-	-	-	-	4500
LSES 200 L	34.2	2910	65.5	0.86	74%	83%	92%	92%	-	-	-	-	-	4500
LSES 225 MT	41.5	2920	79.7	0.85	74%	83%	92%	92%	-	-	-	-	-	4320
LSES 250 MZ	50.5	2925	93.8	0.88	73%	83%	92%	92%	-	-	-	-	-	4320
LSES 280 SC	75	2966	135	0.90	85%	90%	100%	100%	-	-	-	-	-	4320
LSES 280 MC	90	2960	163	0.90	85%	90%	100%	100%	-	-	-	-	-	4320
LSES 315 SN	110	2954	200	0.90	85%	90%	100%	100%	-	-	-	-	-	3600
LSES 315 MP	132	2972	238	0.88	80%	90%	100%	100%	-	-	-	-	-	3600
LSES 315 MP	160	2972	291	0.88	80%	90%	100%	100%	-	-	-	-	-	3600
LSES 315 MP	176	2968	319	0.88	71%	79%	88%	88%	-	-	-	-	-	3600
4 poles														
LSES 80 LG	0.75	1425	1.75	0.78	90%	100%	100%	100%	57%	1.31	2535	3.05	0.78	11700
LSES 80 LG	0.9	1400	1.95	0.82	90%	100%	100%	100%	57%	1.57	2510	3.64	0.82	11700
LSES 90 SL	1.1	1415	2.5	0.82	90%	100%	100%	100%	57%	1.91	2525	4.32	0.82	11700
LSES 90 L	1.5	1415	3.3	0.82	90%	100%	100%	100%	57%	2.61	2525	5.76	0.82	11700
LSES 90 LU	1.8	1435	3.8	0.81	90%	100%	100%	100%	57%	3.13	2545	6.86	0.81	11700
LSES 100 L	2.2	1420	4.8	0.83	90%	100%	100%	100%	57%	3.83	2530	8.3	0.83	9900
LSES 100 LR	3	1415	6.5	0.81	90%	100%	100%	100%	57%	5.22	2525	11.34	0.81	9900
LSES 112 MU	4	1420	8.5	0.84	90%	100%	100%	100%	57%	6.96	2530	14.81	0.84	9900
LSES 132 SU	5.5	1435	11.5	0.80	90%	90%	100%	100%	57%	9.57	2545	19.98	0.80	7600
LSES 132 M	7.5	1435	15.1	0.84	90%	90%	100%	100%	57%	13.05	2545	26.24	0.84	7600
LSES 132 M	9	1440	17.8	0.84	90%	90%	100%	100%	57%	15.66	2550	30.98	0.84	7600
LSES 160 MR	11	1445	21.9	0.84	85%	95%	100%	100%	57%	19.14	2555	38.09	0.84	7600
LSES 160 L	15	1452	29.9	0.84	85%	95%	100%	100%	57%	26.1	2562	51.97	0.84	6030
LSES 180 MT	18	1452	36.4	0.83	80%	90%	100%	100%	57%	32.19	2562	63.32	0.83	5670
LSES 180 LR	22	1454	42.4	0.84	80%	90%	100%	100%	57%	38.28	2564	73.81	0.84	5670
LSES 200 LR	28	1450	55.7	0.83	80%	89%	94%	94%	54%	48.96	2560	97.03	0.83	4500
LSES 225 ST	37	1460	73.5	0.82	85%	95%	100%	100%	57%	64.38	2570	127.99	0.82	4320
LSES 225 MR	45	1460	88.8	0.83	85%	95%	100%	100%	57%	78.3	2570	154.57	0.83	4320
LSES 250 ME	55	1480	108	0.83	85%	95%	100%	100%	57%	95.7	2590	187.92	0.83	4050
LSES 280 SD	75	1480	146	0.83	85%	95%	100%	100%	57%	130.5	2590	253.95	0.83	3420
LSES 280 MD	90	1480	176	0.81	85%	95%	100%	100%	57%	156.6	2590	306.43	0.81	3420
LSES 315 SP	110	1482	211	0.84	80%	90%	100%	100%	57%	191.4	2592	367.38	0.84	2700
LSES 315 MP	132	1482	250	0.85	80%	90%	100%	100%	57%	229.68	2592	435.09	0.85	2700
LSES 315 MP	160	1484	304	0.83	80%	90%	100%	100%	57%	278.4	2594	529.9	0.83	2700
LSES 315 MR	189	1482	356	0.83	76%	85%	95%	95%	54%	329.96	2592	619.6	0.83	2700
6 poles														
LSES 90 SL	0.75	930	2.05	0.68	100%	100%	100%	100%	57%	1.31	1670	3.56	0.68	11700
LSES 90 L	1.1	910	2.9	0.71	100%	100%	100%	100%	57%	1.91	1650	5.08	0.71	11700
LSES 100 L	1.5	915	4	0.69	100%	100%	100%	100%	57%	2.61	1655	6.94	0.69	9900
LSES 112 MG	2.2	940	5.5	0.73	100%	100%	100%	100%	57%	3.83	1680	9.65	0.73	9900
LSES 132 S	3	945	7.5	0.71	100%	100%	100%	100%	57%	5.22	1685	13.04	0.71	7600
LSES 132 M	4	945	9.2	0.77	100%	100%	100%	100%	57%	6.96	1685	16.08	0.77	6700
LSES 132 M	5.5	952	12.4	0.73	100%	100%	100%	100%	57%	9.57	1692	21.5	0.73	6700
LSES 160 M	7.5	966	16.7	0.74	100%	100%	100%	100%	57%	13.05	1706	29.12	0.74	6000
LSES 160 LUR	11	966	24	0.75	95%	100%	100%	100%	57%	19.14	1706	41.82	0.75	5670
LSES 180 L	15	966	31.2	0.81	80%	90%	100%	100%	57%	26.1	1706	54.34	0.81	5670
LSES 200 LR	18.5	962	39.2	0.80	80%	90%	100%	100%	57%	32.19	1702	68.23	0.80	4500
LSES 200 L	22	962	45.7	0.82	80%	90%	100%	100%	57%	38.28	1702	79.57	0.82	4500
LSES 225 MR	30	972	63	0.75	90%	100%	100%	100%	57%	52.2	1712	109.7	0.75	4320
LSES 250 ME	37	982	71	0.85	90%	100%	100%	100%	57%	64.38	1722	124.43	0.85	4050
LSES 280 SC	45	980	87	0.83	90%	100%	100%	100%	57%	78.3	1720	151.52	0.83	3420
LSES 280 MC	55	978	104	0.83	90%	100%	100%	100%	57%	95.7	1718	186.23	0.83	3420
LSES 315 SP	75	988	152	0.78	85%	90%	100%	100%	57%	130.5	1728	265.8	0.78	2700
LSES 315 MP	90	988	181	0.80	85%	90%	100%	100%	57%	156.6	1728	314.89	0.80	2700
LSES 315 MR	110	988	217	0.80	85%	90%	100%	100%	57%	191.4	1728	377.53	0.80	2700
LSES 315 MR	132	986	264	0.80	85%	90%	100%	100%	57%	229.68	1728	460.49	0.80	2700

(1) Data only valid for: 400 V 50 Hz Y motors and frame size ≤ 250 mm - 2 poles

(2) See Vibrations section on page 48

 - Please refer to page 38 for variable speed applications
 - Values given with a voltage drop of 30 V at the drive output

IMfinity® 3-phase induction motors - High efficiency & Premium efficiency

IP55 aluminium frame

Electrical and mechanical characteristics

IE2 powered by the drive

Summary of recommended protection devices

Mains voltage	Cable length	Frame size	Winding protection	Insulated bearings
≤ 480 V	< 20 m	All frame sizes	Standard	No
	> 20 m and < 100 m	< 315	Standard	No
		≥ 315	RIS or drive filter	NDE
> 480 V and ≤ 690 V	< 20 m	< 250	Standard	No
		≥ 250	RIS or drive filter	NDE
	> 20 m and < 100 m	< 250	RIS or drive filter	NDE
		≥ 250	RIS or drive filter	NDE
		≥ 250	RIS or drive filter	NDE (or DE+NDE if no filter for ≥ 315)

RIS: Reinforced Insulation System.

The filter is recommended above frame size 315.

Standard insulation = 1500 V peak and 3500 V/μs.

Service solutions exist (insulation for winding and bearings).

For different cable length(s) and/or voltage(s), please consult Leroy-Somer.



REMINDER: All 2, 4 and 6 pole motors placed on the EU market must be IE3 or IE2 and used with a variable speed drive:

- from 01/01/2015 for power ratings from 7.5 to 375 kW
- from 01/01/2017 for power ratings from 0.75 to 375 kW

Other drive mechanism solutions:



LSRPM: permanent magnet synchronous motors 0.75 to 375 kW

Variable speed application, requiring IP55 protection, high efficiency and/or compact dimensions.



CPLS: induction motors 95 to 1600 Nm

Application for variable speed operation requiring constant power over a wide speed range.



LSMV: induction motors 0.25 to 132 kW

Application for variable speed operation requiring constant torque over a wide speed range.



LSK: D.C. motors 2 to 750 kW



UNIMOTOR FM and HD: servomotors 0.7 to 410 Nm

IMfinity® 3-phase induction motors - High efficiency & Premium efficiency

IP55 aluminium frame

Electrical and mechanical characteristics

IE3 powered by the mains

Type	Rated power P _n kW	Rated torque M _n N.m	Starting torque/ Rated torque M _d /M _n	Maximum torque/ Rated torque M _m /M _n	Starting current/ Rated current I _d /I _n	Moment of inertia J kg.m ²	Weight IM B3 kg	Noise LP db(A)	400 V 50 Hz							
									Rated speed N _n min ⁻¹	Rated current I _n A	Efficiency IEC 60034-2-1 2007			Power factor		
											4/4	3/4	2/4	4/4	3/4	2/4
2 poles																
LSES 80 L	0.75	2.5	3.5	3.5	7.8	0.00095	9.9	58	2890	1.6	81.7	81.7	79.6	0.83	0.76	0.64
LSES 80 LG	1.1	3.7	2.6	3.2	6.8	0.00223	14.1	64	2885	2.25	83.7	84.7	84.0	0.85	0.79	0.67
LSES 90 SL	1.5	5	2.9	3.3	7.5	0.00223	15.6	64	2890	3	85.0	86.0	85.2	0.85	0.79	0.67
LSES 90 L	1.8	6	3.1	3.4	7.5	0.00292	17.8	67	2890	3.75	85.5	86.3	86.2	0.85	0.79	0.67
LSES 90 LU	2.2	7.3	3.1	3.4	8.0	0.00292	20.4	67	2895	4.25	86.3	87.5	87.2	0.86	0.80	0.69
LSES 100 L	3	10	3.5	3.5	8.4	0.00364	24.6	67	2885	5.8	87.3	88.5	88.2	0.86	0.81	0.70
LSES 100 LG	3.7	12.1	2.1	3.0	7.4	0.00941	35.2	71	2920	6.65	88.2	89.1	89.1	0.89	0.85	0.77
LSES 112 MG	4	13.1	2.0	2.9	7.0	0.00941	32.7	71	2920	7.3	88.6	89.7	89.8	0.89	0.85	0.77
LSES 132 S	5.5	18	2.3	3.1	7.4	0.01116	39.2	63	2925	10.3	89.6	90.7	90.7	0.87	0.83	0.74
LSES 132 SM	7.5	24.4	2.1	2.9	6.8	0.01102	55.7	67	2935	13.9	90.7	91.6	91.6	0.86	0.82	0.74
LSES 132 M	9	29.2	2.2	3.3	7.7	0.01203	59.3	67	2945	16.6	91.2	91.9	91.7	0.86	0.81	0.72
LSES 160 MP	11	35.7	1.9	2.9	6.9	0.0139	70	72	2940	20.2	91.6	92.3	92.1	0.86	0.82	0.73
LSES 160 M	15	48.6	2.3	2.8	7.8	0.049	95	69	2945	26.7	92.1	92.8	92.8	0.88	0.86	0.80
LSES 160 L	18.5	59.9	2.8	3.2	7.6	0.0551	100	68	2950	32.8	92.6	93.3	93.2	0.88	0.85	0.77
LSES 180 MR	22	71.2	3.2	3.2	8.7	0.0628	105	69	2950	38.8	92.9	93.6	93.6	0.88	0.85	0.77
LSES 200 LR	30	97.3	2.6	3.1	7.6	0.1106	170	73	2945	52.2	93.5	94.3	94.4	0.89	0.87	0.82
LSES 200 L	37	120	2.0	3.1	7.1	0.2492	201	73	2945	63.7	93.9	94.5	94.4	0.89	0.87	0.81
LSES 225 MR	45	146	2.7	3.4	8.1	0.1597	227	76	2950	77.5	94.3	94.8	94.8	0.89	0.86	0.79
LSES 250 MZ	55	178	2.5	3.5	8.2	0.1754	234	72	2945	94.5	94.6	95.2	95.2	0.89	0.86	0.80
LSES 280 SC	75	241	2.3	3.3	8.1	0.4092	350	79	2970	126	95.2	95.4	95.1	0.90	0.88	0.82
LSES 280 MC	90	289	2.5	3.6	8.5	0.476	382	80	2972	151	95.4	95.7	95.4	0.90	0.88	0.82
LSES 315 SN	110	354	2.6	3.1	8.0	0.5343	452	79	2968	185	95.5	95.9	95.8	0.90	0.88	0.84
LSES 315 MP	132	423	2.3	3.2	7.7	0.5784	660	80	2978	227	95.6	95.6	95.0	0.88	0.86	0.80
LSES 315 MP	160	513	2.2	3.3	7.7	1.2646	705	80	2978	274	95.8	95.9	94.3	0.88	0.86	0.80
LSES 315 MP	200	642	2.2	3.5	7.9	1.3841	768	80	2974	340	96.0	96.2	95.9	0.88	0.86	0.80
4 poles																
LSES 80 LG	0.75	4.95	2.2	2.9	6.2	0.00335	13.6	48	1450	1.65	83.2	83.9	82.6	0.80	0.72	0.59
LSES 80 LG	0.9	5.9	2.6	3.1	6.4	0.00381	14.1	48	1450	1.9	83.5	84.2	83.0	0.80	0.72	0.59
LSES 90 SL	1.1	7.25	2.4	3.2	6.9	0.00418	16.2	45	1450	2.3	84.8	85.7	85.1	0.81	0.73	0.61
LSES 90 LU	1.5	9.85	2.9	3.7	7.7	0.00524	20.4	51	1452	3.2	85.6	86.2	84.9	0.79	0.70	0.57
LSES 100 L	1.8	11.8	2.4	2.7	6.6	0.00561	22.6	48	1452	3.7	86.0	86.5	85.4	0.82	0.74	0.62
LSES 100 LR	2.2	14.4	3.2	3.8	8.1	0.00676	25.8	47	1454	4.6	87.1	87.7	86.7	0.79	0.71	0.58
LSES 100 LG	3	19.6	2.5	3.3	7.2	0.01152	31	55	1460	6.05	88.3	89.1	88.6	0.81	0.74	0.61
LSES 112 MU	4	26.2	2.7	3.1	7.1	0.01429	37	53	1458	8.1	88.8	89.6	89.2	0.80	0.73	0.62
LSES 132 SM	5.5	35.9	2.8	3.6	8.6	0.02286	52	59	1462	10.3	90.3	91.1	90.8	0.85	0.79	0.68
LSES 132 MU	7.5	49.1	3.0	3.4	8.0	0.02965	62.6	61	1458	14	90.6	91.7	92.1	0.86	0.82	0.73
LSES 160 MR	9	58.7	3.1	3.7	8.9	0.03574	77.8	62	1464	16.7	91.2	92.0	91.8	0.85	0.79	0.68
LSES 160 M	11	71.7	2.3	3.1	7.3	0.0712	93	59	1466	20.5	91.6	92.6	92.8	0.85	0.81	0.72
LSES 160 LUR	15	97.6	2.6	3.5	8.4	0.0954	100	58	1468	27.7	92.3	93.1	93.2	0.85	0.81	0.71
LSES 180 M	18.5	120	3.0	2.9	7.8	0.2075	130	68	1468	33.7	92.9	93.7	93.7	0.85	0.81	0.72
LSES 180 LUR	22	143	3.3	3.2	8.2	0.1555	155	68	1470	40.9	93.2	93.7	93.6	0.83	0.78	0.69
LSES 200 LU	30	194	3.0	2.8	7.3	0.2704	225	63	1476	55.1	93.8	94.3	94.1	0.84	0.80	0.70
LSES 225 SR	37	239	3.3	3.2	8.0	0.2897	236	63	1480	69.8	94.2	94.5	94.1	0.81	0.76	0.65
LSES 225 MG	45	290	2.3	2.9	7.3	0.6573	318	70	1484	83	94.6	94.9	94.5	0.83	0.79	0.69
LSES 250 ME	55	354	2.3	2.7	7.3	0.7793	350	69	1484	101	94.9	95.3	95.2	0.83	0.79	0.70
LSES 280 SD	75	482	2.5	3.2	8.2	0.9595	428	69	1486	137	95.2	95.4	95.1	0.83	0.79	0.69
LSES 280 MD	90	579	2.6	3.5	8.5	1.0799	470	68	1484	166	95.5	95.7	95.4	0.82	0.77	0.66
LSES 315 SP	110	706	3.1	2.9	7.7	2.4322	690	76	1488	198	95.6	95.6	95.1	0.84	0.80	0.70
LSES 315 MP	132	848	3.1	2.8	7.3	3.223	740	76	1486	235	95.7	95.9	95.5	0.85	0.81	0.72
LSES 315 MP	160	1030	2.6	2.8	7.2	3.223	740	76	1486	291	95.9	96.0	95.5	0.83	0.78	0.67
LSES 315 MR	200	1290	3.0	2.9	7.4	3.2324	820	76	1486	361	96.1	96.3	95.9	0.83	0.78	0.68
6 poles																
LSES 90 SL	0.75	7.55	1.9	2.3	4.5	0.00378	16	56	950	1.9	79.1	80.1	78.3	0.72	0.63	0.50
LSES 90 LU	1.1	11	2.4	2.7	4.9	0.00519	21.5	56	956	2.75	81.9	82.3	80.3	0.71	0.61	0.48
LSES 100 LG	1.5	14.8	2.4	2.8	5.7	0.01523	30	43	966	3.6	83.5	84.1	82.6	0.72	0.64	0.50
LSES 112 MU	2.2	21.7	2.3	2.8	5.5	0.01899	37	46	966	5.4	84.5	85.0	83.7	0.70	0.61	0.49
LSES 132 SM	3	29.5	2.8	3.2	6.6	0.02528	48	50	972	6.85	86.5	87.0	85.9	0.73	0.65	0.53
LSES 132 M	4	39.3	2.7	2.9	6.5	0.03027	54	56	972	9	87.4	88.0	87.0	0.73	0.66	0.53
LSES 132 MU	5.5	54.4	2.6	2.9	6.4	0.03699	63.1	57	966	11.8	88.2	89.4	89.2	0.76	0.70	0.58
LSES 160 MU	7.5	73.2	2.0	3.1	6.0	0.1295	82	58	978	18.6	89.6	89.7	88.4	0.72	0.65	0.53
LSES 180 L	11	107	3.1	3.5	8.7	0.2048	130	62	982	22.6	91.2	91.4	90.4	0.77	0.69	0.57
LSES 180 LUR	15	146	3.1	3.2	8.5	0.253	150	63	980	30.6	91.5	91.9	91.3	0.77	0.70	0.58
LSES 200 L	18.5	180	2.2	2.9	7.1	0.33	200	61	980	36.3	92.1	92.8	92.6	0.80	0.75	0.66
LSES 200 LU	22	214	2.8	3.6	7.4	0.3901	236	62	980	44.6	92.5	93.0	92.5	0.77	0.71	0.61
LSES 225 MG	30	291	2.3	2.5	6.7	0.7222	284	64	986	54.9	93.4	93.8	93.4	0.84	0.80	0.70
LSES 250 ME	37	358	2.4	2.8	7.1	0.9234	310	64	986	66.6	93.9	94.4	94.3	0.85	0.81	0.72
LSES 280 SC	45	437	2.2	2.5	6.6	1.1279	377	64	984	81.2	94.0	94.6	94.5	0.85	0.82	0.74
LSES 280 MD	55	533	2.8	3.0	7.7	1.3995	444	59	986	98.7	94.7	95.2	95.0	0.85	0.81	0.72
LSES 315 SP	75	723	3.0	2.6	7.5	2.8937	630	71	990	147	94.9	95.0	94.2	0.78	0.73	0.61
LSES 315 MP	90	868	3.1	2.7	7.8	3.4127	700									

IMfinity® 3-phase induction motors - High efficiency & Premium efficiency IP55 aluminium frame

Electrical and mechanical characteristics

IE3 powered by the mains

Type	Rated power P_n kW	380 V 50 Hz				415V 50 Hz				460 V 60 Hz			
		Rated speed	Rated current	Efficiency	Power factor	Rated speed	Rated current	Efficiency	Power factor	Rated speed	Rated current	Efficiency	Power factor
		N_n min ⁻¹	I_n A	η 4/4	$\cos \phi$ 4/4	N_n min ⁻¹	I_n A	η 4/4	$\cos \phi$ 4/4	N_n min ⁻¹	I_n A	η 4/4	$\cos \phi$ 4/4
2 poles													
LSES 80 L	0.75	2875	1.65	80.9	0.86	2900	1.55	81.6	0.81	3505	1.4	82.5	0.80
LSES 80 LG	1.1	2870	2.35	82.7	0.87	2895	2.2	84.2	0.83	3505	1.95	84.9	0.83
LSES 90 SL	1.5	2880	3.15	84.2	0.87	2900	2.9	85.7	0.83	3510	2.65	86.5	0.83
LSES 90 L	1.8	2880	3.95	85.0	0.87	2900	3.6	85.6	0.83	3510	3.3	86.9	0.83
LSES 90 LU	2.2	2875	4.4	85.9	0.88	2905	4.2	86.7	0.85	3505	3.75	87.6	0.85
LSES 100 L	3	2870	6	87.1	0.88	2900	5.65	87.8	0.84	3505	5.1	87.6	0.85
LSES 100 LG	3.7	2905	7	87.9	0.90	2925	6.4	88.5	0.88	3535	5.8	88.9	0.88
LSES 112 MG	4	2905	7.65	88.1	0.90	2925	7.1	89.0	0.88	3535	6.4	89.6	0.88
LSES 132 S	5.5	2910	10.6	89.2	0.88	2930	10	89.9	0.85	3540	8.9	90.7	0.86
LSES 132 SM	7.5	2925	14.5	90.1	0.87	2945	13.5	91.1	0.85	3545	12.1	91.6	0.85
LSES 132 M	9	2935	17.2	90.7	0.88	2950	16.3	91.4	0.84	3558	14.5	91.9	0.85
LSES 160 MP	11	2930	21	91.2	0.87	2945	19.7	91.9	0.84	3550	17.6	92.3	0.85
LSES 160 M	15	2935	27.9	91.9	0.89	2950	25.9	92.2	0.87	3550	23.3	92.5	0.87
LSES 160 L	18.5	2945	34	92.4	0.89	2954	32	92.9	0.87	3558	28.6	93.4	0.87
LSES 180 MR	22	2940	40.4	92.7	0.89	2958	38	93.1	0.87	3560	33.8	93.8	0.87
LSES 200 LR	30	2935	55	93.3	0.89	2954	50.4	93.8	0.88	3556	45.3	94.0	0.89
LSES 200 L	37	2930	66.6	93.7	0.90	2950	61.8	94.2	0.88	3552	55.6	94.5	0.89
LSES 225 MR	45	2940	81	94.0	0.90	2956	75.4	94.6	0.88	3560	67.2	94.9	0.89
LSES 250 MZ	55	2940	98.3	94.3	0.90	2954	92.3	94.8	0.88	3560	81.6	95.2	0.89
LSES 280 SC	75	2964	132	94.8	0.91	2974	123	95.4	0.89	3574	110	95.2	0.90
LSES 280 MC	90	2968	158	95.1	0.91	2972	148	95.5	0.89	3574	131	95.5	0.90
LSES 315 SN	110	2962	195	95.2	0.91	2970	179	95.6	0.89	3574	161	95.7	0.90
LSES 315 MP	132	2974	237	95.4	0.89	2984	220	95.7	0.87	3580	198	95.4	0.88
LSES 315 MP	160	2976	286	95.6	0.89	2980	267	95.9	0.87	3580	239	95.6	0.88
LSES 315 MP	200	2970	357	95.8	0.89	2980	335	96.1	0.86	3580	297	96.1	0.88
4 poles													
LSES 80 LG	0.75	1440	1.65	82.6	0.82	1452	1.6	83.29	0.78	1758	1.45	85.1	0.76
LSES 80 LG	0.9	1440	2	83.0	0.82	1452	1.8	83.60	0.78	1758	1.7	85.6	0.76
LSES 90 SL	1.1	1445	2.35	84.1	0.83	1454	2.3	85.42	0.79	1760	2.05	86.6	0.78
LSES 90 LU	1.5	1445	3.25	85.3	0.82	1456	3.2	85.75	0.77	1760	2.8	87.3	0.76
LSES 100 L	1.8	1445	3.9	85.4	0.83	1454	3.9	86.20	0.79	1760	3.3	87.0	0.78
LSES 100 LR	2.2	1445	4.7	86.7	0.82	1456	4.6	87.27	0.77	1760	4.15	88.4	0.76
LSES 100 LG	3	1452	6.2	87.7	0.84	1462	6.05	88.36	0.78	1766	5.35	90.0	0.79
LSES 112 MU	4	1450	8.3	88.6	0.83	1462	8.05	88.88	0.78	1764	7.1	90.2	0.79
LSES 132 SM	5.5	1456	10.7	89.6	0.87	1466	10.2	90.43	0.83	1768	9.05	91.7	0.83
LSES 132 MU	7.5	1450	14.5	90.4	0.87	1462	13.6	90.90	0.85	1766	12.1	92.0	0.84
LSES 160 MR	9	1458	17.4	90.9	0.86	1466	16.5	91.50	0.83	1768	14.7	92.4	0.83
LSES 160 M	11	1462	21.1	91.4	0.86	1470	19.8	91.91	0.84	1774	17.8	92.7	0.84
LSES 160 LUR	15	1464	28.7	92.1	0.86	1472	26.8	92.55	0.84	1774	24.2	93.3	0.83
LSES 180 M	18.5	1466	35.3	92.6	0.86	1474	33.1	93.16	0.84	1774	29.5	93.8	0.84
LSES 180 LUR	22	1466	42.4	93.0	0.85	1474	40.3	93.41	0.81	1770	36.4	93.8	0.81
LSES 200 LU	30	1472	56.8	93.6	0.85	1478	53.9	94.10	0.82	1778	48.1	94.5	0.83
LSES 225 SR	37	1476	71.7	93.9	0.83	1482	69.5	94.30	0.79	1782	61.2	94.5	0.80
LSES 225 MG	45	1480	86.2	94.3	0.85	1486	80.7	94.94	0.82	1786	72.3	95.0	0.82
LSES 250 ME	55	1482	105	94.6	0.84	1486	98.3	95.13	0.82	1786	87.9	95.4	0.82
LSES 280 SD	75	1484	142	95.0	0.85	1486	134	95.34	0.81	1786	120	95.6	0.82
LSES 280 MD	90	1482	170	95.3	0.84	1488	164	95.50	0.80	1788	148	95.7	0.80
LSES 315 SP	110	1486	206	95.4	0.85	1488	193	95.83	0.82	1790	176	95.8	0.82
LSES 315 MP	132	1484	243	95.6	0.86	1488	229	95.70	0.84	1790	210	96.2	0.82
LSES 315 MP	160	1484	300	95.8	0.85	1488	289	96.00	0.80	1790	254	96.2	0.82
LSES 315 MR	200	1484	371	96.0	0.85	1488	358	96.01	0.81	1790	316	96.4	0.82
6 poles													
LSES 90 SL	0.75	945	1.95	78.9	0.74	956	1.9	79.5	0.70	-	-	-	-
LSES 90 LU	1.1	950	2.75	81.3	0.75	960	2.75	82.1	0.68	-	-	-	-
LSES 100 LG	1.5	962	3.75	82.6	0.73	970	3.65	83.4	0.68	-	-	-	-
LSES 112 MU	2.2	960	5.4	84.3	0.73	970	5.4	84.5	0.67	-	-	-	-
LSES 132 SM	3	968	7	85.8	0.76	974	6.8	86.6	0.71	-	-	-	-
LSES 132 M	4	968	9.2	86.8	0.76	974	9.05	87.7	0.70	-	-	-	-
LSES 132 MU	5.5	960	12.1	88.0	0.78	968	11.7	88.5	0.74	-	-	-	-
LSES 160 MU	7.5	974	19.4	89.1	0.74	980	18.3	89.7	0.69	-	-	-	-
LSES 180 L	11	980	23.2	91.2	0.79	984	22.4	91.3	0.75	-	-	-	-
LSES 180 LUR	15	976	31.5	91.2	0.79	982	30.5	91.6	0.75	-	-	-	-
LSES 200 L	18.5	976	37.6	91.7	0.82	982	35.8	92.3	0.78	-	-	-	-
LSES 200 LU	22	978	43.8	92.2	0.79	984	42.2	92.7	0.74	-	-	-	-
LSES 225 MG	30	984	57.4	92.9	0.86	986	54.6	93.4	0.82	-	-	-	-
LSES 250 ME	37	984	69.2	93.6	0.86	988	66.1	94.0	0.83	-	-	-	-
LSES 280 SC	45	982	85.2	93.7	0.86	986	79.5	94.1	0.84	-	-	-	-
LSES 280 MD	55	984	102	94.3	0.86	988	96.1	94.8	0.84	-	-	-	-
LSES 315 SP	75	990	149	94.8	0.80	992	145	95.2	0.76	-	-	-	-
LSES 315 MP	90	990	177	95.0	0.82	992	169	95.1	0.78	-	-	-	-
LSES 315 MR	110	988	215	95.1	0.82	992	203	95.7	0.78	-	-	-	-
LSES 315 MR	132	990	260	95.4	0.81	990	245	95.5	0.78	-	-	-	-

IMfinity® 3-phase induction motors - High efficiency & Premium efficiency

IP55 aluminium frame

Electrical and mechanical characteristics

IE3 powered by the drive

IP55 ALUMINIUM MOTORS

Type	400 V 50 Hz				% Rated torque M _n at					400 V 87 Hz Δ ¹				Maximum mechanical speed ²
	Rated power	Rated speed	Rated current	Power factor	10 Hz	17 Hz	25 Hz	50 Hz	87 Hz	Rated power	Rated speed	Rated current	Power factor	
	P _n kW	N _n min ⁻¹	I _n A	Cos φ 4/4						P _n kW	N _n min ⁻¹	I _n A	Cos φ 4/4	
2 poles														
LSES 80 L	0.75	2850	1.65	0.83	90%	100%	100%	100%	57%	1.31	5070	2.88	0.83	13500
LSES 80 LG	1.1	2850	2.35	0.85	85%	100%	100%	100%	57%	1.91	5070	4.06	0.85	11700
LSES 90 SL	1.5	2845	3.15	0.85	85%	100%	100%	100%	57%	2.61	5065	5.5	0.85	11700
LSES 90 L	1.8	2870	3.75	0.85	85%	100%	100%	100%	57%	3.13	5090	6.5	0.85	11700
LSES 90 LU	2.2	2850	4.5	0.86	85%	100%	100%	100%	57%	3.83	5070	7.87	0.86	11700
LSES 100 L	3	2845	6.1	0.86	85%	100%	100%	100%	57%	5.22	5065	10.67	0.86	9900
LSES 100 LG	3.7	2890	7.3	0.89	85%	100%	100%	100%	57%	6.44	5090	12.7	0.89	9900
LSES 112 MG	4	2890	7.9	0.89	85%	100%	100%	100%	57%	6.96	5110	13.8	0.89	9900
LSES 132 S	5.5	2895	10.9	0.87	85%	100%	100%	100%	57%	9.57	5115	18.96	0.87	6700
LSES 132 SM	7.5	2910	14.7	0.86	85%	95%	100%	100%	57%	13.05	5130	25.56	0.86	6700
LSES 132 M	9	2925	17.5	0.86	85%	95%	100%	100%	57%	15.66	5145	30.47	0.86	6700
LSES 160 MP	11	2920	21.3	0.86	85%	95%	100%	100%	57%	19.14	5140	37.08	0.86	6700
LSES 160 M	15	2920	28.7	0.88	85%	95%	100%	100%	57%	26.1	5140	49.94	0.88	6000
LSES 160 L	18.5	2930	35	0.88	85%	95%	100%	100%	57%	32.19	5150	60.95	0.88	6000
LSES 180 MR	22	2930	41.65	0.88	85%	95%	100%	100%	57%	38.28	5150	72.46	0.88	5670
LSES 200 LR	30	2925	56	0.89	85%	90%	100%	100%	-	-	-	-	-	4500
LSES 200 L	37	2920	69.5	0.89	80%	90%	100%	100%	-	-	-	-	-	4500
LSES 225 MR	45	2930	83.3	0.89	80%	90%	100%	100%	-	-	-	-	-	4320
LSES 250 MZ	55	2925	93.85	0.89	73%	83%	92%	100%	-	-	-	-	-	4320
LSES 280 SC	75	2966	135	0.90	85%	90%	100%	100%	-	-	-	-	-	4050
LSES 280 MC	90	2960	162	0.90	85%	90%	100%	100%	-	-	-	-	-	4050
LSES 315 SN	110	2954	199	0.90	85%	90%	100%	100%	-	-	-	-	-	3600
LSES 315 MP	132	2972	239	0.88	80%	90%	100%	100%	-	-	-	-	-	3600
LSES 315 MP	160	2972	290	0.88	80%	90%	100%	100%	-	-	-	-	-	3600
LSES 315 MP	176	2968	320	0.88	71%	79%	88%	88%	-	-	-	-	-	3600
4 poles														
LSES 80 LG	0.75	1430	1.7	0.80	90%	100%	100%	100%	57%	1.31	2540	2.96	0.80	11700
LSES 80 LG	0.9	1440	2.45	0.80	90%	100%	100%	100%	57%	1.55	2550	3.47	0.80	11700
LSES 90 SL	1.1	1430	2.3	0.81	90%	100%	100%	100%	57%	1.91	2540	4.23	0.81	11700
LSES 90 LU	1.5	1440	3.3	0.79	90%	100%	100%	100%	57%	2.61	2550	5.76	0.79	11700
LSES 100 L	1.8	1440	3.9	0.82	90%	100%	100%	100%	57%	3.13	2550	6.77	0.82	9900
LSES 100 LR	2.2	1435	4.8	0.79	90%	100%	100%	100%	57%	3.83	2545	8.3	0.79	9900
LSES 100 LG	3	1445	6.4	0.81	90%	100%	100%	100%	57%	5.22	2555	11.09	0.81	9900
LSES 112 MU	4	1440	8.4	0.80	90%	100%	100%	100%	57%	6.96	2550	14.56	0.80	9900
LSES 132 SM	5.5	1450	11	0.85	90%	90%	100%	100%	57%	9.57	2560	19.13	0.85	6700
LSES 132 MU	7.5	1440	14.9	0.86	90%	90%	100%	100%	57%	13.05	2550	25.9	0.86	6700
LSES 160 MR	9	1452	17.8	0.85	90%	90%	100%	100%	57%	15.66	2562	30.98	0.85	6000
LSES 160 M	11	1454	21.6	0.85	85%	95%	100%	100%	57%	19.14	2564	37.58	0.85	6000
LSES 160 LUR	15	1456	29.2	0.85	85%	95%	100%	100%	57%	26.1	2566	50.79	0.85	5670
LSES 180 M	18.5	1460	36.3	0.85	80%	90%	100%	100%	57%	32.19	2570	63.15	0.85	5670
LSES 180 LUR	22	1458	43.6	0.83	80%	90%	100%	100%	57%	38.28	2568	75.85	0.83	4500
LSES 200 LU	30	1468	59.2	0.84	85%	95%	100%	100%	57%	52.2	2578	102.93	0.84	4500
LSES 225 SR	37	1474	73	0.81	85%	95%	100%	100%	57%	64.38	2584	126.97	0.81	4320
LSES 225 MG	45	1478	87.8	0.83	85%	95%	100%	100%	57%	78.3	2588	152.88	0.83	4050
LSES 250 ME	55	1480	108	0.83	85%	95%	100%	100%	57%	95.7	2590	187.92	0.83	4050
LSES 280 SD	75	1480	146	0.83	85%	95%	100%	100%	57%	130.5	2590	253.95	0.83	3420
LSES 280 MD	90	1480	176	0.82	85%	95%	100%	100%	57%	156.6	2590	306.43	0.82	3420
LSES 315 SP	110	1482	211	0.84	80%	90%	100%	100%	57%	191.4	2592	367.38	0.84	2700
LSES 315 MP	132	1482	250	0.85	80%	90%	100%	100%	57%	229.6	2592	435.09	0.85	2700
LSES 315 MP	160	1484	304	0.83	80%	90%	100%	100%	57%	278.4	2594	529.9	0.83	2700
LSES 315 MR	189	1482	356	0.83	80%	90%	90%	90%	57%	329.96	2592	619.6	0.83	2700
6 poles														
LSES 90 SL	0.75	930	1.95	0.7	100%	100%	100%	100%	57%	1.31	1670	3.39	0.72	11700
LSES 90 LU	1.1	940	2.75	0.7	100%	100%	100%	100%	57%	1.91	1680	4.74	0.71	11700
LSES 100 LG	1.5	954	3.8	0.7	100%	100%	100%	100%	57%	2.61	1694	6.6	0.72	9900
LSES 112 MU	2.2	954	5.5	0.7	100%	100%	100%	100%	57%	3.83	1694	9.57	0.70	9900
LSES 132 SM	3	962	6.9	0.7	100%	100%	100%	100%	57%	5.22	1702	12.02	0.73	6700
LSES 132 M	4	962	9.3	0.7	100%	100%	100%	100%	57%	6.96	1702	16.17	0.73	6700
LSES 132 MU	5.5	954	12.2	0.8	100%	100%	100%	100%	57%	9.57	1694	21.33	0.76	6700
LSES 160 MU	7.5	970	16.35	0.8	100%	100%	100%	100%	57%	13.05	1710	28.44	0.76	6700
LSES 180 L	11	976	23.45	0.8	95%	100%	100%	100%	57%	19.14	1716	40.8	0.77	5670
LSES 180 LUR	15	974	32	0.8	80%	90%	100%	100%	57%	26.1	1714	55.7	0.77	4500
LSES 200 L	18.5	972	38.2	0.8	80%	90%	100%	100%	57%	32.19	1712	66.53	0.80	4500
LSES 200 LU	22	974	46.3	0.8	80%	90%	100%	100%	57%	38.28	1714	80.59	0.77	4500
LSES 225 MG	30	980	58.6	0.8	90%	100%	100%	100%	57%	52.2	1720	101.92	0.84	4050
LSES 250 ME	37	982	71.5	0.9	90%	100%	100%	100%	57%	64.38	1722	124.43	0.85	4050
LSES 280 SC	45	980	87.1	0.9	90%	100%	100%	100%	57%	78.3	1720	151.52	0.85	3420
LSES 280 MD	55	984	104	0.9	90%	100%	100%	100%	57%	95.7	1724	181.15	0.85	3420
LSES 315 SP	75	988	152	0.8	85%	90%	100%	100%	57%	130.5	1728	265.8	0.78	2700
LSES 315 MP	90	988	181	0.8	85%	90%	100%	100%	57%	156.6	1728	314.89	0.80	2700
LSES 315 MR	110	988	217	0.8	85%	90%	100%	100%	57%	191.4	1728	377.53	0.80	2700
LSES 315 MR	132	986	265	0.8	85%	90%	100%	100%	57%	229.68	1726	460.49	0.80	2700

(1) Data only valid for: 400 V 50 Hz Y motors and frame size ≤ 250 mm - 2 poles

(2) See Vibrations section on page 48

 - Please refer to page 38 for variable speed applications
 - Values given with a voltage drop of 30 V at the drive output

IMfinity® 3-phase induction motors - High efficiency & Premium efficiency

IP55 aluminium frame

Electrical and mechanical characteristics

IE3 powered by the drive

Summary of recommended protection devices

Mains voltage	Cable length	Frame size	Winding protection	Insulated bearings
≤ 480 V	< 20 m	All frame sizes	Standard	No
	> 20 m and < 100 m	< 315	Standard	No
		≥ 315	RIS or drive filter	NDE
> 480 V and ≤ 690 V	< 20 m	< 250	Standard	No
		≥ 250	RIS or drive filter	NDE
	> 20 m and < 100 m	< 250	RIS or drive filter	NDE
		≥ 250	RIS or drive filter	NDE
		≥ 250	RIS or drive filter	NDE (or DE+NDE if no filter for ≥ 315)

RIS: Reinforced Insulation System.

The filter is recommended above frame size 315.

Standard insulation = 1500 V peak and 3500 V/μs.

Service solutions exist (insulation for winding and bearings).

For different cable length(s) and/or voltage(s), please consult Leroy-Somer.



REMINDER: All 2, 4 and 6 pole motors placed on the EU market must be IE3 or IE2 and used with a variable speed drive:

- from 01/01/2015 for power ratings from 7.5 to 375 kW
- from 01/01/2017 for power ratings from 0.75 to 375 kW

Other drive mechanism solutions:



LSRPM: permanent magnet synchronous motors 0.75 to 375 kW

Variable speed application, requiring IP55 protection, high efficiency and/or compact dimensions.



CPLS: induction motors 95 to 1600 Nm

Application for variable speed operation requiring constant power over a wide speed range.



LSMV: induction motors 0.25 to 132 kW

Application for variable speed operation requiring constant torque over a wide speed range.



LSK: D.C. motors 2 to 750 kW



UNIMOTOR FM and HD: servomotors 0.7 to 410 Nm

IMfinity® 3-phase induction motors - High efficiency & Premium efficiency

IP55 aluminium frame

Electrical and mechanical characteristics

Mains connection

DESCRIPTIVE TABLE OF TERMINAL BOXES FOR 400 V RATED SUPPLY VOLTAGE (in accordance with EN 50262)

Series	Type	No. of poles	Terminal box material	Power + auxiliaries	
				Number of drill holes	Drill hole diameter
LSES	80	2; 4; 6	Plastic	1 + 1 knock-out	ISO M20 x 1.5
	90	2; 4; 6			
	100	2; 4; 6			
	112	2; 4; 6			
	132*	2; 4; 6	Aluminium alloy	2	ISO M25 x 1.5
	160* L/LU/LUR/M/MU	2; 4; 6			
	180 M/MR/MT/L/LR/LUR	2; 4; 6		3	2 ISO x M40 + 1 ISO x M16
	200 L/LR/LU	2; 4; 6			
	225 ST/SG/SR/MT/MR/MG	2; 4; 6			
	250 MZ	2			
	250 ME	4; 6		2 ISO x M50 + 1 ISO x M16	
	280 SC/SD/MC/MD	2; 4; 6			
	315 SN	2			
	315 SP/MP/MR	2; 4; 6		0	Removable undrilled mounting plate

*As an option, both ISO M25 cable glands may be replaced by 1 ISO x M25 and 1 ISO x M32 (to comply with standard DIN 42925).

TERMINAL BLOCKS DIRECTION OF ROTATION

Standard motors are fitted with a block of 6 terminals complying with standard NFC 51 120, with the terminal markings complying with IEC 60034-8 (or NF EN 60034-8).

When the motor is running in U1, V1, W1 or 1U, 1V, 1W from a direct mains supply L1, L2, L3, it turns clockwise when seen from the drive shaft end.

If any two of the phases are changed over, the motor will run in an anti-clockwise direction (make sure that the motor has been designed to run in both directions).

If the motor is fitted with accessories (thermal protection or space heater), these must be connected on screw dominos with labelled wires.

Tightening torque for the nuts on the terminal blocks.

Terminal	M4	M5	M6	M8	M10	M12	M16
Torque N.m	1	2.5	4	10	20	35	65

LSES series	230/400 V connections		400/690 V connections
	No. of poles	Terminals	Terminals
80 to 112	2; 4; 6	M5	M5
132 S/SU	2; 4; 6	M5	M5
132 SM/M/MU	2; 4; 6	M6	M6
160	2; 4; 6	M6	M6
180 M/MT/L	2; 4; 6	M6	M6
180 MR/LR	4; 6	M8	M6
180 LUR	4	M8	M6
	6	M6	M6
200 L/LU	2; 6	M8	M8
200 LR	2; 4; 6	M8	M6
225 ST/SG/SR	4	M10	M8
225 MT	2	M10	M8
225 MR	2; 4	M8	M8
225 MG	4	M10	M8
	6	M8	M8
250 ME	4	M10	M10
	6	M8	M8
250 MZ	2	M10	M8
280 SC	2	M12	M10
	6	M10	M8
280 MC	2	M12	M10
280 SD	4	M12	M10
280 MD	4	M12	M10
	6	M10	M10
315 SN	2	M16	M12
315 SP	4	M16	M12
	6	M12	M10
315 MP	6	M12	M10
	2; 4; 6	M16	M12
315 MR	2	M16	M16
	2	M16	M12
	2; 4	M16	M16
	6	M16	M12

IMfinity® 3-phase induction motors - High efficiency & Premium efficiency

IP55 aluminium frame

Dimensions

Shaft extensions

Dimensions in millimetres

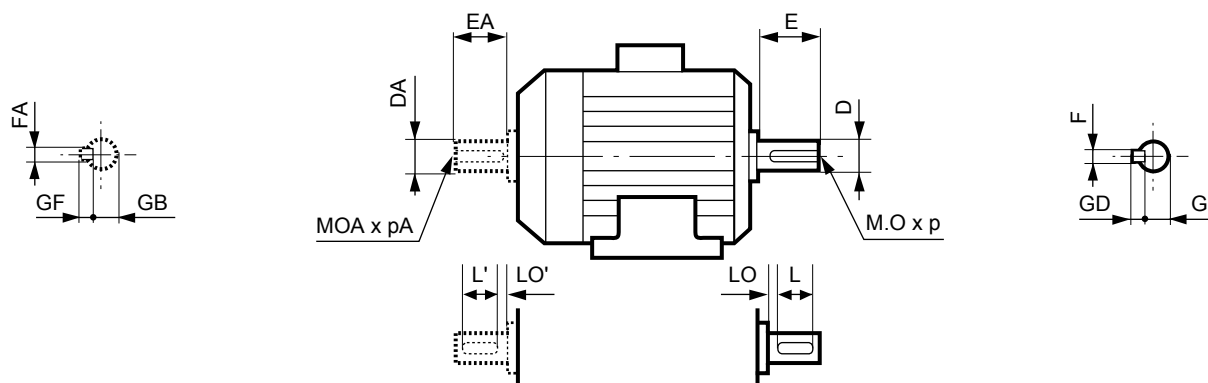

Type	Main shaft extensions																	
	4 and 6 poles									2 poles								
	F	GD	D	G	E	O	p	L	LO	F	GD	D	G	E	O	p	L	LO
LSES 80 L/LU/LG	6	6	19j6	15.5	40	6	16	30	6	6	6	19j6	15.5	40	6	16	30	6
LSES 90 SL/L/LU	8	7	24j6	20	50	8	19	40	6	8	7	24j6	20	50	8	19	40	6
LSES 100 L/LR/LG	8	7	28j6	24	60	10	22	50	6	8	7	28j6	24	60	10	22	50	6
LSES 112 MR/MG/MU	8	7	28j6	24	60	10	22	50	6	8	7	28j6	24	60	10	22	50	6
LSES 112 M	8	7	28j6	24	60	10	22	50	6	8	7	28j6	24	60	10	22	50	6
LSES 132 S/SU/SM/M/MU	10	8	38k6	33	80	12	28	63	10	10	8	38k6	33	80	12	28	63	10
LSES 160 MP/MR/M/MU/L/LU/LUR	12	8	42k6	37	110	16	36	100	6	12	8	42k6	37	110	16	36	100	6
LSES 180 M/MT/MR/L/LR/LUR	14	9	48k6	42.5	110	16	36	98	12	14	9	48k6	42.5	110	16	36	98	12
LSES 200 L/LR/LU	16	10	55m6	49	110	20	42	97	13	16	10	55m6	49	110	20	42	97	13
LSES 225 ST/MR/MT/MG	18	11	60m6	53	140	20	42	126	14	16	10	55m6	49	110	20	42	97	13
LSES 225 SR	18	11	60m6	53	140	20	42	125	15	16	10	55m6	49	110	20	42	97	13
LSES 250 ME/MZ/MF	18	11	65m6	58	140	20	42	126	14	18	11	60m6	53	140	20	42	126	14
LSES 280 SC/SD/SU/SK/MC/MD	20	12	75m6	67.5	140	20	42	125	15	18	11	65m6	58	140	20	42	125	14
LSES 315 SN/SP/MP/MR	22	14	80m6	71	170	20	42	155	15	18	11	65m6	58	140	20	42	126	14

Type	Secondary shaft extensions																	
	4 and 6 poles									2 poles								
	FA	GF	DA	GB	EA	OA	pA	L'	LO'	FA	GF	DA	GB	EA	OA	pA	L'	LO'
LSES 80 L/LU/LG	5	5	14j6	11	30	5	15	25	3.5	5	5	14j6	11	30	5	15	25	3.5
LSES 90 SL/L/LU	6	6	19j6	15.5	40	6	16	30	6	6	6	19j6	15.5	40	6	16	30	6
LSES 100 L/LR/LG	8	7	24j6	20	50	8	19	40	6	8	7	24j6	20	50	8	19	40	6
LSES 112 MR/MG/MU	8	7	24j6	20	50	8	19	40	6	8	7	24j6	20	50	8	19	40	6
LSES 112 M	8	7	24j6	20	50	8	19	40	6	8	7	24j6	20	50	8	19	40	6
LSES 132 S/SU/SM/M/MU	8	7	28k6	24	60	10	22	50	6	8	7	28k6	24	60	10	22	50	6
LSES 160 MU	12	8	42k6	37	110	16	36	100	6	8	7	28k6	24	60	10	22	50	6
LSES 160 MP/MR	10	8	38k6	33	80	12	28	63	10	10	8	38k6	33	80	12	28	63	10
LSES 160 M/L/LU/LUR	12	8	42k6	37	110	16	36	100	6	12	8	42k6	37	110	16	36	100	6
LSES 180 M/MT/MR/L/LR/LUR	14	9	48k6	42.5	110	16	36	97	13	14	9	48k6	42.5	110	16	36	97	13
LSES 200 L/LR/LU	16	10	55m6	49	110	20	42	97	13	16	10	55m6	49	110	20	42	97	13
LSES 225 ST/MR/MT/MG	18	11	60m6	53	140	20	42	126	14	16	10	55m6	49	110	20	42	97	13
LSES 225 SR	18	11	60m6	53	140	20	42	125	15	16	10	55m6	49	110	20	42	97	13
LSES 250 ME/MZ/MF	18	11	60m6	53	140	20	42	126	14	18	11	60m6	53	140	20	42	126	14
LSES 280 SC/SD/SU/SK/MC/MD	18	11	65m6	58	140	20	42	126	14	18	11	65m6	58	140	20	42	126	14
LSES 315 SN	20	12	75m6	67.5	140	20	42	125	15	18	11	65m6	58	140	20	42	125	14
LSES 315 SP/MP/MR	22	14	80m6	71	170	24	42	155	15	18	11	65m6	58	140	20	42	126	14

IMfinity® 3-phase induction motors - High efficiency & Premium efficiency

IP55 aluminium frame

Dimensions

Foot mounted IM 1001 (IM B3)

Dimensions in millimetres

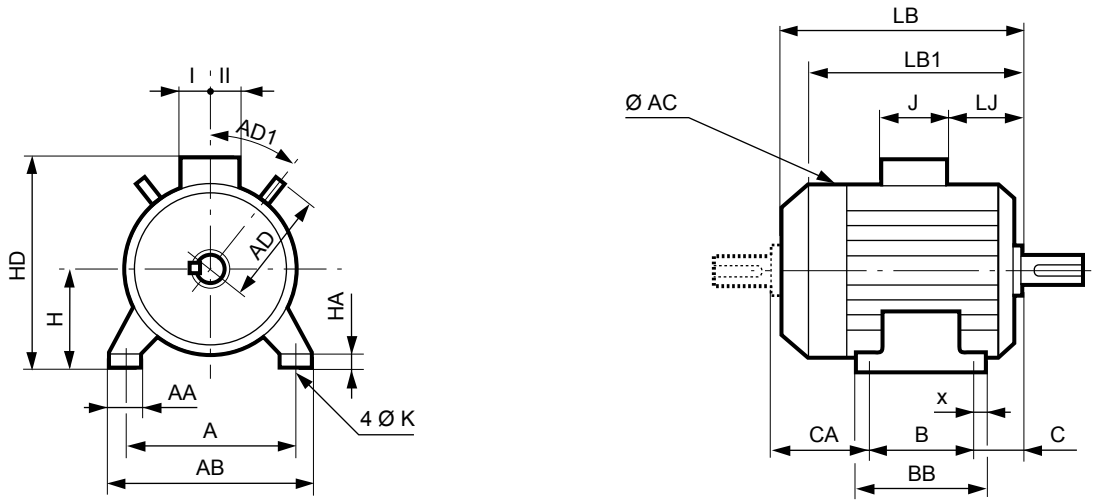

Type	Main dimensions																				
	A	AB	B	BB	C	X	AA	K	HA	H	AC*	HD	LB	LB1**	LJ	J	I	II	AD	AD1	CA
LSES 80 L	125	157	100	120	50	10	29	9	10	80	170	205	215	177	25.5	86	43	43	-	-	68
LSES 80 LU	125	157	100	120	50	10	29	10	10	80	170	205	267	232	25.5	86	43	43	-	-	120
LSES 80 LG	125	157	100	125	50	14	31	9	10	80	185	215	247	204	25.5	86	43	43	-	-	100
LSES 90 SL/L	140	172	125	162	56	28	39	10	11	90	190	225	244.5	204	25.5	86	43	43	-	-	68
LSES 90 LU	140	172	125	162	56	28	39	10	11	90	190	225	265	230	25.5	86	43	43	-	-	88
LSES 100 L	160	196	140	165	63	12	40	12	13	100	200	240	290	250	26.5	86	43	43	118	45	92
LSES 100 LR	160	196	140	165	63	12	40	12	13	100	200	240	309	264	26.5	86	43	43	118	45	106
LSES 100 LG	160	196	140	170	63	11	49	12	13	100	230	249	315	264	35.5	86	43	43	-	-	111
LSES 112 M	190	220	140	165	70	13	45	12	14	112	200	252	290	265	26.5	86	43	43	118	45	104
LSES 112 MR	190	220	140	165	69	13	45	12	14	112	200	252	309	264	26.5	86	43	43	118	45	104
LSES 112 MU	190	220	140	165	70	12	52	12	14	112	235	261	332	288	35.5	86	43	43	-	-	123
LSES 112 MG	190	220	140	165	70	12	52	12	14	112	235	261	315	265	35.5	86	43	43	-	-	110
LSES 132 S	216	250	140	170	89	16	42	12	16	132	220	304	350	306	32.5	126	63	63	130	45	121
LSES 132 SU	216	250	140	170	89	16	42	12	16	132	220	304	383	329	32.5	126	63	63	130	45	148
LSES 132 SM	216	250	140	208	89	15	50	12	15	132	265	322	385	327	42	126	63	63	140	45	153
LSES 132 M	216	250	178	208	89	15	50	12	15	132	265	322	385	327	17	126	63	63	140	45	123
LSES 132 MU	216	250	178	208	89	15	50	12	15	132	265	322	332	351	17	126	63	63	140	45	150
LSES 160 MP	254	294	210	294	108	20	64	14	25	160	264	350	468	407	58.5	126	63	63	155	45	154
LSES 160 MR	254	294	210	294	108	20	64	14	25	160	264	350	495	440	58.5	126	63	63	155	45	181
LSES 160 M	254	294	254	294	108	20	60	14.5	25	160	312	395	495	435	42.8	135	88	64	-	-	138
LSES 160 MU	254	294	254	294	108	20	60	14.5	25	160	312	395	510	435	42.8	135	88	64	-	-	153
LSES 160 L	254	294	254	294	108	20	60	14.5	25	160	312	395	495	435	42.8	135	88	64	-	-	138
LSES 160 LU/LUR	254	294	254	294	108	20	60	14.5	25	160	312	395	510	450	42.8	135	88	64	-	-	153
LSES 180 MT	279	324	241	316	121	20	79	14.5	28	180	312	428	495	435	54.75	186	112	98	-	-	138
LSES 180 LR	279	324	279	316	121	20	79	14.5	28	180	312	428	520	450	54.75	186	112	98	-	-	125
LSES 180 L	279	339	279	329	121	25	86	14.5	25	180	350	436	552	481	63.5	186	112	98	-	-	157
LSES 180 LUR	279	339	279	329	121	25	86	14.5	25	180	350	436	614	481	63.5	186	112	98	-	-	219
LSES 180 M	279	339	241	291	121	25	86	14.5	25	180	350	436	552	481	63.5	186	112	98	-	-	195
LSES 180 MUR/MR	279	324	279	316	121	20	79	14.5	28	180	312	428	520	522	54.8	186	112	98	-	-	125
LSES 200 LR	318	378	305	365	133	30	108	18.5	30	200	350	456	620	539	69.5	186	112	98	-	-	188
LSES 200 L	318	388	305	375	133	35	103	18.5	36	200	390	476	621	539	77	186	112	98	-	-	189
LSES 200 LU	318	388	305	375	133	35	103	18.5	36	200	390	476	669	587	77	186	112	98	-	-	237
LSES 225 ST	356	431	286	386	149	50	127	18.5	36	225	390	535	627	545	61	231	119	142	-	-	203
LSES 225 SR	356	431	311	386	149	50	127	18.5	36	225	390	535	676	545	74	292	119	142	-	-	253
LSES 225 MT	356	431	311	386	149	50	127	18.5	36	225	390	535	627	545	61	231	119	142	-	-	178
LSES 225 MR	356	431	311	386	149	50	127	18.5	36	225	390	535	676	593	61	231	119	142	-	-	228
LSES 225 MG	356	420	311	375	142	30	65	18.5	30	225	479	630	810	727.5	68	292	151	181	-	-	360
LSES 250 MZ	406	470	349	449	167.5	70	150	24	47	250	390	560	676	593	61	231	119	142	-	-	171
LSES 250 ME	406	470	349	420	168	35	90	24	36	250	479	656	810	716	67.5	292	151	181	-	-	303
LSES 250 MF	406	470	349	420	168	35	90	24	36	250	479	656	870	776	67.5	292	151	181	-	-	353
LSES 280 MC	457	520	419	478	190	35	90	24	35	280	479	686	810	716	67.5	292	151	181	-	-	211
LSES 280 SC	457	520	368	478	190	35	90	24	35	280	479	686	810	716	67.5	292	151	181	-	-	262
LSES 280 SK	457	533	368	495	190	40	85	24	35	280	586	746	921	827	99	292	151	181	-	-	312
LSES 280 SU	457	533	368	495	190	40	85	24	35	280	586	746	991	897	99	292	151	181	-	-	382
LSES 280 SD	457	520	368	478	190	35	90	24	35	280	479	686	870	870	67.5	292	151	181	-	-	271
LSES 280 MD	457	520	419	478	190	35	90	24	35	280	479	686	870	870	67.5	292	151	181	-	-	271
LSES 315 SN	508	594	406	537	216	40	140	28	50	315	479	805	870	776	4.5	418	180	236	-	-	248
LSES 315 SP	508	594	406	537	216	40	114	28	70	315	586	865	947	845	61	418	180	236	-	-	341
LSES 315 MP	508	594	457	537	216	40	114	28	70	315	586	865	947	845	61	418	180	236	-	-	290
LSES 315 MR	508	594	457	537	216	40	114	28	70	315	586	865	1017	947	61	418	180	236	-	-	360

* AC: housing diameter without lifting rings

** LB1: non-ventilated motor

IMfinity® 3-phase induction motors - High efficiency & Premium efficiency

IP55 aluminium frame

Dimensions

Foot and flange mounted IM 2001 (IM B35)

Dimensions in millimetres

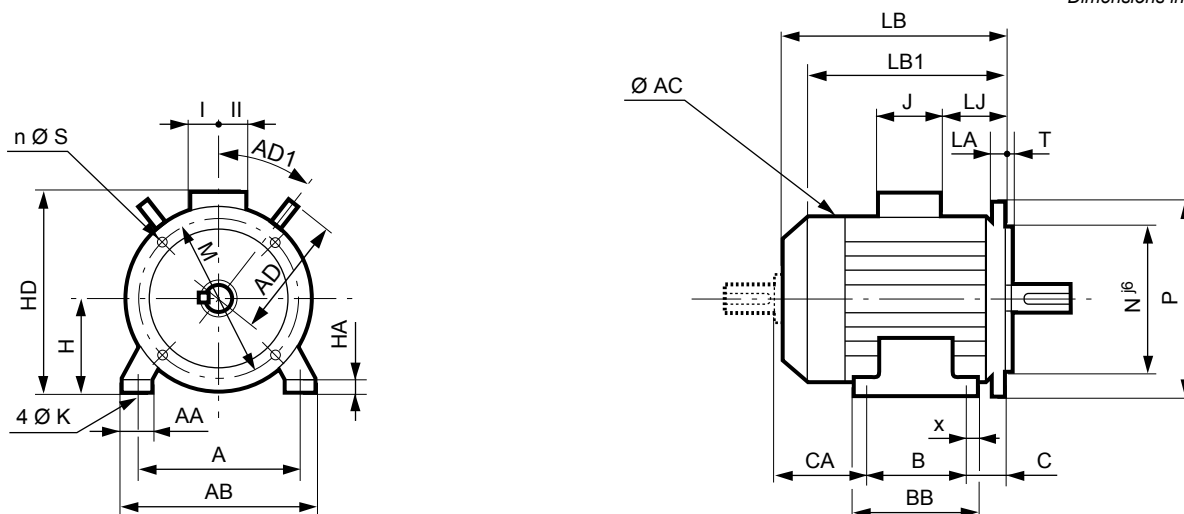

Type	Main dimensions																					
	A	AB	B	BB	C	X	AA	K	HA	H	AC*	HD	LB	LB1**	LJ	J	I	II	AD	AD1	CA	Symbol
LSES 80 L	125	157	100	120	50	10	29	9	10	80	170	205	215	204	25.5	86	43	43	-	-	68	FF 165
LSES 80 LU	125	157	100	120	50	10	29	10	10	80	170	205	267	232	25.5	86	43	43	-	-	120	FF 166
LSES 80 LG	125	157	100	125	50	14	31	9	10	80	185	215	247	204	25.5	86	43	43	-	-	100	FF 165
LSES 90 SL/L	140	172	125	162	76	28	39	10	11	90	190	225	265	224	46	86	43	43	-	-	68	FF 165
LSES 90 LU	140	172	125	162	76	28	39	10	11	90	190	225	285	250	45.5	86	43	43	-	-	88	FF 165
LSES 100 L	160	196	140	165	63	12	40	12	13	100	200	240	290	250	26.5	86	43	43	118	45	92	FF 215
LSES 100 LR	160	196	140	165	63	12	40	12	13	100	200	240	309	264	26.5	86	43	43	118	45	111	FF 215
LSES 100 LG	160	196	140	170	63	11	49	12	13	100	230	249	315	264	35.5	86	43	43	-	-	111	FF 215
LSES 112 MR	190	220	140	165	69	13	45	12	14	112	200	252	309	264	26.5	86	43	43	118	45	104	FF 215
LSES 112 M	190	220	140	165	70	13	45	12	14	112	200	252	290	264	26.5	86	43	43	118	45	104	FF 215
LSES 112 MU	190	220	140	165	70	12	52	12	14	112	235	261	332	317	35.5	86	43	43	-	-	123	FF 215
LSES 112 MG	190	220	140	165	70	12	52	12	14	112	235	261	315	265	35.5	86	43	43	-	-	110	FF 215
LSES 132 S	216	250	140	170	89	16	42	12	16	132	220	304	350	306	32.5	126	63	63	130	45	126	FF 265
LSES 132 SU	216	250	140	170	89	16	42	12	16	132	220	304	383	329	32.5	126	63	63	130	45	153	FF 265
LSES 132 SM	216	250	140	208	89	15	50	12	15	132	265	322	385	327	42	126	63	63	140	45	158	FF 265
LSES 132 M	216	250	178	208	89	15	50	12	15	132	265	322	385	351	17	126	63	63	140	45	123	FF 265
LSES 132 MU	216	250	178	208	89	15	50	12	15	132	265	322	412	351	17	126	63	63	140	45	150	FF 265
LSES 160 MP	254	294	210	294	108	20	64	14	25	160	264	350	468	407	58.5	126	63	63	155	45	154	FF 300
LSES 160 MR	254	294	210	294	108	20	64	14	25	160	264	350	495	440	58.5	126	63	63	155	45	181	FF 300
LSES 160 M	254	294	254	294	108	20	60	14.5	25	160	312	395	495	435	42.8	135	88	64	-	-	138	FF 300
LSES 160 MU	254	294	254	294	108	20	60	14.5	25	160	312	395	510	435	42.8	135	88	64	-	-	153	FF 300
LSES 160 L	254	294	254	294	108	20	60	14.5	25	160	312	395	495	435	42.8	135	88	64	-	-	138	FF 300
LSES 160 LU/LUR	254	294	254	294	108	20	60	14.5	25	160	312	395	510	450	42.8	135	88	64	-	-	153	FF 300
LSES 180 MT	279	324	241	316	121	20	79	14.5	28	180	312	428	495	435	54.75	186	112	98	-	-	138	FF 300
LSES 180 LR	279	324	279	316	121	20	79	14.5	28	180	312	428	520	450	54.75	186	112	98	-	-	125	FF 300
LSES 180 L	279	339	279	329	121	25	86	14.5	25	180	350	436	552	481	63.5	186	112	98	-	-	157	FF 300
LSES 180 LUR	279	339	279	329	121	25	86	14.5	25	180	350	436	614	450	63.5	186	112	98	-	-	219	FF 300
LSES 180 M	279	339	241	291	121	25	86	14.5	25	180	350	436	552	481	63.5	186	112	98	-	-	195	FF 300
LSES 180 MUR/MR	279	324	279	316	121	20	79	14.5	28	180	312	428	520	522	54.8	186	112	98	-	-	125	FF 300
LSES 200 LR	318	378	305	365	133	30	108	18.5	30	200	350	456	620	539	69.5	186	112	98	-	-	188	FF 350
LSES 200 L	318	388	305	375	133	35	103	18.5	36	200	390	476	621	539	77	186	112	98	-	-	189	FF 350
LSES 200 LU	318	388	305	375	133	35	103	18.5	36	200	390	476	669	587	77	186	112	98	-	-	237	FF 350
LSES 225 ST	356	431	286	386	149	50	127	18.5	36	225	390	535	627.5	545	61	231	119	142	-	-	203	FF 400
LSES 225 SR	356	431	286	386	149	50	127	18.5	36	225	390	535	675.5	593	61	231	119	142	-	-	253	FF 400
LSES 225 MT	356	431	311	386	149	50	127	18.5	36	225	390	535	627.5	545	61	231	119	142	-	-	178	FF 400
LSES 225 MR	356	431	311	386	149	50	127	18.5	36	225	390	535	675.5	593	61	231	119	142	-	-	228	FF 400
LSES 225 MG	356	420	311	375	142	30	65	18.5	30	225	479	630	810	727.5	68	292	151	181	-	-	360	FF 400
LSES 250 MZ	406	470	349	449	167.5	70	150	24	47	250	390	560	675.5	593	61	231	119	142	-	-	171	FF 500
LSES 250 ME	406	470	349	420	168	35	90	24	36	250	479	656	810	716	67.5	292	151	181	-	-	303	FF 500
LSES 250 MF	406	470	349	420	168	35	90	24	36	250	479	656	870	776	67.5	292	151	181	-	-	353	FF 500
LSES 280 MC	457	520	419	478	190	35	90	24	35	280	479	686	810	716	67.5	292	151	181	-	-	211	FF 500
LSES 280 SC	457	520	368	478	190	35	90	24	35	280	479	686	810	716	67.5	292	151	181	-	-	262	FF 500
LSES 280 SK	457	533	368	495	190	40	85	24	35	280	586	746	921	827	99	292	151	181	-	-	312	FF 500
LSES 280 SU	457	533	368	495	190	40	85	24	35	280	586	746	991	897	99	292	151	181	-	-	382	FF 500
LSES 280 SD	457	520	368	478	190	35	90	24	35	280	479	686	870	870	67.5	292	151	181	-	-	271	FF 500
LSES 280 MD	457	520	419	478	190	35	90	24	35	280	479	686	870	870	67.5	292	151	181	-	-	271	FF 500
LSES 315 SN	508	594	406	537	216	40	140	28	50	315	479	805	870	776	4.5	418	180	236	-	-	248	FF 600
LSES 315 SP	508	594	406	537	216	40	114	28	70	315	586	865	947	845	61.5	418	180	236	-	-	341	FF 600
LSES 315 MP	508	594	457	537	216	40	114	28	70	315	586	865	947	845	61.5	418	180	236	-	-	290	FF 600
LSES 315 MR	508	594	457	537	216	40	114	28	70	315	586	865	1017	947	61.5	418	180	236	-	-	360	FF 600

* AC: housing diameter without lifting rings

** LB1: non-ventilated motor

IMfinity® 3-phase induction motors - High efficiency & Premium efficiency

IP55 aluminium frame

Dimensions

Foot and face mounted IM 2101 (IM B34)

Dimensions in millimetres

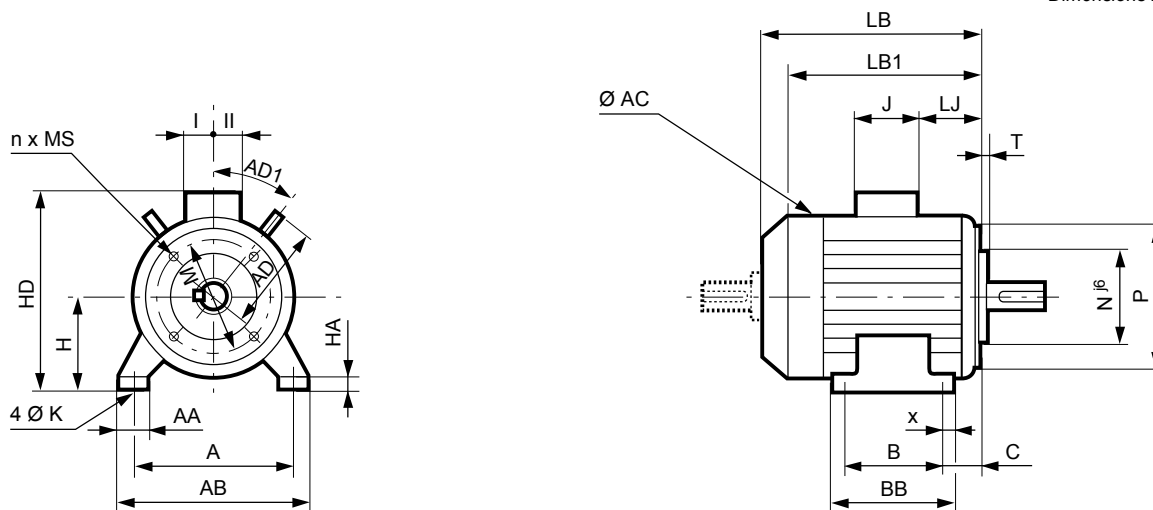

Type	Main dimensions																					
	A	AB	B	BB	C	X	AA	K	HA	H	AC*	HD	LB	LB1**	LJ	J	I	II	AD	AD1	CA	Symbol
LSES 80 L	125	157	100	120	50	10	29	9	10	80	170	205	215	177	25.5	86	43	43	-	-	68	FT 100
LSES 80 LU	125	157	100	120	50	10	29	10	10	80	170	205	267	232	25.5	86	43	43	-	-	120	FT 100
LSES 80 LG	125	157	100	125	50	14	31	9	10	80	185	215	247	204	25.5	86	43	43	-	-	100	FT 100
LSES 90 SL/L	140	172	125	162	56	28	39	10	11	90	190	225	244.5	204	25.5	86	43	43	-	-	68	FT 115
LSES 90 LU	140	172	125	162	56	28	39	10	11	90	190	225	265	230	25.5	86	43	43	-	-	88	FT 115
LSES 100 L	160	196	140	165	63	12	40	12	13	100	200	240	290	250	26.5	86	43	43	118	45	92	FT 130
LSES 100 LR	160	196	140	165	63	12	40	12	13	100	200	240	309	264	26.5	86	43	43	118	45	111	FT 130
LSES 100 LG	160	196	140	170	63	11	49	12	13	100	230	249	315	264	25.5	86	43	43	-	-	111	FT 130
LSES 112 MR	190	220	140	165	69	13	45	12	14	112	200	252	309	264	26.5	86	43	43	118	45	104	FT 130
LSES 112 M	190	220	140	165	70	13	45	12	14	112	200	252	290	264	26.5	86	43	43	118	45	104	FT 130
LSES 112 MU	190	220	140	165	70	12	52	12	14	112	235	261	332	288	35.5	86	43	43	-	-	123	FT 130
LSES 112 MG	190	220	140	165	70	12	52	12	14	112	235	261	315	255	35.5	86	43	43	-	-	110	FT 130
LSES 132 S	216	250	140	170	89	16	42	12	16	132	220	304	350	306	32.5	126	63	63	130	45	126	FT 215
LSES 132 SU	216	250	140	170	89	16	42	12	16	132	220	304	377	329	32.5	126	63	63	130	45	153	FT 215
LSES 132 SM	216	250	140	208	114	15	50	12	15	132	265	322	407	327	42	126	63	63	140	45	158	FT 215
LSES 132 M	216	250	178	208	89	15	50	12	15	132	265	322	385	354	17	126	63	63	140	45	123	FT 215
LSES 132 MU	216	250	178	208	89	15	50	12	15	132	265	322	412	351	17	126	63	63	140	45	150	FT 215
LSES 160 MP	254	294	210	294	108	20	64	14	25	160	264	350	468	407	58.5	126	63	63	155	45	154	FT 215
LSES 160 MR	254	294	210	294	108	20	64	14	25	160	264	350	495	440	58.5	126	63	63	155	45	181	FT 215

* AC: housing diameter without lifting rings

** LB1: non-ventilated motor

IMfinity® 3-phase induction motors - High efficiency & Premium efficiency

IP55 aluminium frame

Dimensions

Face mounted IM 3601 (IM B14)

Dimensions in millimetres

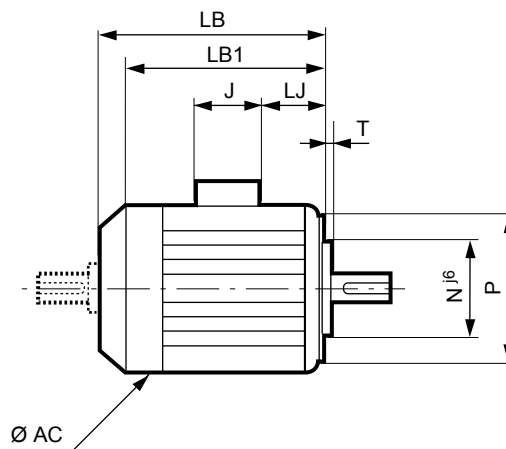
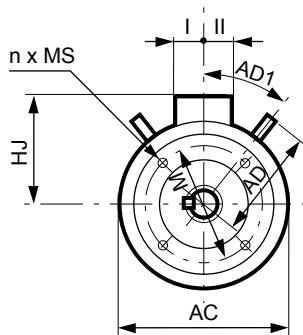

Symbol IEC	Faceplate dimensions					
	M	N	P	T	n	MS
FT 100	100	80	120	3	4	M6
FT 100	100	80	120	3	4	M6
FT 100	100	80	120	3	4	M6
FT 115	115	95	140	3	4	M8
FT 115	115	95	140	3	4	M8
FT 130	130	110	160	3.5	4	M8
FT 130	130	110	160	3.5	4	M8
FT 130	130	110	160	3.5	4	M8
FT 130	130	110	160	3.5	4	M8
FT 130	130	110	160	3.5	4	M8
FT 130	130	110	160	3.5	4	M8
FT 215	215	180	250	4	4	M12
FT 215	215	180	250	4	4	M12
FT 215	215	180	250	4	4	M12
FT 215	215	180	250	4	4	M12
FT 215	215	180	250	4	4	M12
FT 215	215	180	250	4	4	M12

Type	Main dimensions										
	AC*	LB	LB1**	HJ	LJ	J	I	II	AD	AD1	
LSES 80 L	170	215	177	125	26.5	86	43	43	-	-	
LSES 80 LU	170	267	232	125	25.5	86	43	43	-	-	
LSES 80 LG	185	247	204	135	25.5	86	43	43	-	-	
LSES 90 SL/L	190	244.5	206	135	25.5	86	43	43	-	-	
LSES 90 LU	190	265	230	135	25.5	86	43	43	-	-	
LSES 100 L	200	290	250	140	26.5	86	43	43	118	45	
LSES 100 LR	200	309	264	140	26.5	86	43	43	118	45	
LSES 100 LG	230	315	264	149	35.5	86	43	43	-	-	
LSES 112 M	200	290	264	140	26.5	86	43	43	118	45	
LSES 112 MR	200	309	264	140	26.5	86	43	43	118	45	
LSES 112 MU	235	332	288	149	35.5	86	43	43	-	-	
LSES 112 MG	235	315	255	149	35.5	86	43	43	-	-	
LSES 132 S	220	350	306	172	32.5	126	63	63	130	45	
LSES 132 SU	220	377	329	172	32.5	126	63	63	130	45	
LSES 132 SM	265	407	327	190	42	126	63	63	140	45	
LSES 132 M	265	385	354	190	17	126	63	63	140	45	
LSES 132 MU	265	412	351	190	17	126	63	63	140	45	
LSES 160 MP	264	468	407	190	58.5	126	63	63	155	45	
LSES 160 MR	264	495	440	190	58.5	126	63	63	155	45	

* AC: housing diameter without lifting rings

** LB1: non-ventilated motor

IMfinity® 3-phase induction motors - High efficiency & Premium efficiency

IP55 aluminium frame

Construction

Bearings and lubrication

PERMANENTLY GREASED BEARINGS

Under normal operating conditions, the service life in hours of the lubricant is indicated in the table below for ambient temperatures less than 55°C.

Series	Type	No. of poles	Types of permanently greased bearing		Grease life according to speed of rotation								
					3000 min ⁻¹			1500 min ⁻¹			1000 min ⁻¹		
					25°C	40°C	55°C	25°C	40°C	55°C	25°C	40°C	55°C
LSES	80 L	2	6203 CN	6204 C3	≥40000	≥40000	25000	-	-	-	-	-	-
	80 LG	2; 4	6204 C3	6205 C3	≥40000	≥40000	24000	≥40000	≥40000	31000	-	-	-
	90 SL/L	2; 4; 6									≥40000	≥40000	34000
	90 LU	4	6205 C3	6205 C3	-	-	-	≥40000	≥40000	30000	-	-	-
	100 L	2; 4; 6	6205 C3	6206 C3	≥40000	≥40000	22000	≥40000	≥40000	30000	≥40000	≥40000	33000
	100 LR	4			-	-	-				-	-	
	112 M	2	6205 C3	6206 C3	≥40000	≥40000	22000	-	-	-	-	-	-
	112 MG	2; 6									≥40000	≥40000	33000
	112 MU	4	6206 C3	6206 C3	-	-	-	≥40000	≥40000	30000	-	-	-
	132 S	2; 6	6206 C3	6208 C3	≥40000	≥40000	19000	-	-	-	≥40000	≥40000	30000
	132 SU	2; 4						≥40000	≥40000	25000	-	-	-
	132 SM/M	2; 4; 6	6207 C3	6308 C3	≥40000	≥40000	19000	≥40000	≥40000	25000	≥40000	≥40000	30000
	132 MU	4; 6	6307 C3	6308 C3	-	-	-	≥40000	≥40000	25000	≥40000	≥40000	30000
	160 MR	2; 4	6308 C3	6309 C3	≥40000	35000	15000	≥40000	≥40000	24000	-	-	-
	160 MP	2; 4	6208 C3	6309 C3	≥40000	35000	18000	≥40000	≥40000	24000	-	-	-
	160 M/MU	6	6210 C3	6309 C3	-	-	-	-	-	-	≥40000	≥40000	27000
	160 L	2; 4; 6			≥40000	30000	15000	≥40000	≥40000	23000	≥40000	≥40000	27000
	160 LUR	4; 6	6210 C3	6310 C3	-	-	-	≥40000	≥40000	23000	≥40000	≥40000	27000
	180 MT	2; 4			≥40000	30000	15000	-	-	-	-	-	
	180 M	4	6212 C3	6310 C3	-	-	-	≥40000	≥40000	24900	-	-	-
	180 L	6			-	-	-	≥40000	≥40000	28000			
	180 LR	4	6210 C3	6310 C3	-	-	-	≥40000	≥40000	23000	-	-	-
	180 LUR	4; 6	6312 C3	6310 C3	-	-	-	≥40000	≥40000	22000	≥40000	≥40000	27000
	200 L	2; 6	6214 C3	6312 C3	≥40000	25000	12500	-	-	-	≥40000	≥40000	27000
	200 LR	2; 4; 6	6312 C3	6312 C3	≥40000	25000	12500	≥40000	≥40000	22000	≥40000	≥40000	27000
	200 LU	4; 6			-	-	-						
	225 ST	4	6214 C3	6313 C3	-	-	-	≥40000	≥40000	21000	-	-	-
	225 MT	2			≥40000	22000	11000	-	-	-			
225 SR	4	6312 C3	6313 C3	-	-	-	≥40000	≥40000	21000	-	-	-	
225 MR	2; 4; 6			≥40000	22000	11000	≥40000	≥40000	26000				
225 SG	4	6216 C3	6314 C3	-	-	-	≥40000	≥40000	20000	-	-	-	
225 MG	4; 6			≥40000	≥40000	25000							

Note: On request, all motors can be fitted with grease nipples except the 132 S/SU.

IMfinity® 3-phase induction motors - High efficiency & Premium efficiency

IP55 aluminium frame

Construction

Bearings and lubrication

BEARINGS WITH GREASE NIPPLES

The chart opposite shows the greasing intervals, depending on the type of motor, for standard bearing assemblies of frame size ≥ 160 mm fitted with grease nipples, operating at an ambient temperature of 25°C, 40°C and 55°C on a horizontal shaft machine.

The chart below is valid for LSES motors lubricated with Polyrex EM103 grease, which is used as standard.

SPECIAL CONSTRUCTION AND ENVIRONMENT

For vertical shaft machines, the greasing intervals will be approximately 80% of the values stated in the table below.

Note: The quality and quantity of grease and the greasing interval are shown on the machine nameplate.

For special assemblies (motors fitted with DE roller bearings or other types), machines of frame size ≥ 160 mm have bearings with grease nipples.

Instructions for bearing maintenance are given on the nameplates on these machines.

Series	Type	No. of poles	Type of bearing for bearings with grease nipples		Quantity of grease g	Greasing intervals in hours								
			N.D.E.	D.E.		3000 min ⁻¹			1500 min ⁻¹			1000 min ⁻¹		
						25°C	40°C	55°C	25°C	40°C	55°C	25°C	40°C	55°C
LSES	160 M/MU*	2; 4; 6	6210 C3	6309 C3	13	22200	11100	5550	32400	16200	8100	39800	19900	9950
	160 L*													
	180 MR*	2	6210 C3	6310 C3	15	19600	9800	4900	-	-	-	-	-	-
	180 MT*	2; 4												
	180 LR*	4												
	180 LUR*	4; 6	6312 C3	6310 C3	20	-	-	-	26800	13400	6700	35000	17500	8750
	180 M*	4	6212 C3	6310 C3	15	-	-	-	29200	14600	7300	-	-	-
	180 L*	6												
	200 LR*	2; 4; 6	6312 C3	6312 C3	20	15200	7600	3800	26800	13400	6700	35000	17500	8750
	200 LU*	4; 6												
	200 L*	2; 6	6214 C3	6312 C3	20	14600	7300	3650	-	-	-	34600	17300	8650
	225 ST*	4	6214 C3	6313 C3	25	-	-	-	25200	12600	6300	-	-	-
	225 MT*	2												
	225 SR/MR*	2; 4; 6	6312 C3	6313 C3	25	13400	6700	3350	25200	12600	6300	33600	16800	8400
	225 SG*	4	6216 C3	6314 C3	25	-	-	-	23600	11800	5900	-	-	-
	225 MG*	4; 6												
	250 MZ	2	6312 C3	6313 C3	25	13400	6700	3350	-	-	-	-	-	-
	250 ME	4; 6	6216 C3	6314 C3	25	-	-	-	16800	8400	16800	22800	11400	5700
	280 SC/MC	2												
	280 SC	6	6216 C3	6316 C3	35	-	-	-	-	-	-	32200	16100	8050
280 SD/MD	4; 6	6218 C3	6316 C3	35	-	-	-	1900	3800	7600	29600	14800	7400	
315 SN	2	6216 C3	6316 C3	35	5600	2800	1400	-	-	-	-	-	-	
315 MP	2	6317 C3	6317 C3	40	5200	2600	1300	-	-	-	-	-	-	
315 SP	4	6317 C3	6320 C3	50	-	-	-	14000	7000	14000	-	-	-	
315 MP/MR	4; 6													

* bearing with grease nipples on request

STANDARD BEARING FITTING ARRANGEMENTS

LSES series		Horizontal shaft	Vertical shaft	
			Shaft facing down	Shaft facing up
Foot mounted motors	Mounting arrangement	B3	V5	V6
	standard mounting	The DE bearing is: - located at DE for types ≤ 160 MP/MR/LR - locked for types ≥ 160 M/MU/L/LUR	The DE bearing is: - located at DE for types ≤ 160 MP/MR/LR - locked for types ≥ 160 M/MU/L/LUR	The DE bearing is locked for all motors
	on request	DE bearing locked for frame < 132	The DE bearing is locked	
Flange mounted motors (or foot and flange)	Mounting arrangement	B5/B35/B14/B34	V1/V15/V18/V58	V3/V36/V19/V69
	standard mounting	The DE bearing is locked	The DE bearing is locked	The DE bearing is locked

IMfinity® 3-phase induction motors - High efficiency & Premium efficiency

IP55 aluminium frame

Construction

Axial loads

HORIZONTAL MOTOR

For a bearing life L_{10h} of 25,000 hours and 40,000 hours

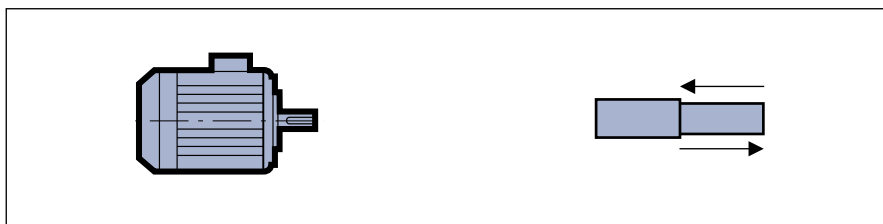

Series	Type	No. of poles	Permissible axial load (in daN) on main shaft extension for standard bearing assembly													
			3000 min ⁻¹						1500 min ⁻¹				1000 min ⁻¹			
			→		←		→		←		→		←		→	
25 000 hours	40 000 hours	25 000 hours	40 000 hours	25 000 hours	40 000 hours	25 000 hours	40 000 hours	25 000 hours	40 000 hours	25 000 hours	40 000 hours	25 000 hours	40 000 hours	25 000 hours	40 000 hours	
LSES	80 L	2	30	21	60	51	-	-	-	-	-	-	-	-	-	-
	80 LG	2; 4	28	19	68	59	48	34	88	74	-	-	-	-	-	-
	90 SL/L	2; 4; 6	29	23	69	56	45	32	85	72	56	40	96	80	-	-
	90 LU	2; 4; 6	22	13	72	63	38	25	88	75	47	32	97	82	-	-
	100 L	2; 6	42	28	92	78	-	-	-	-	78	57	128	107	-	-
	100 LR	4	-	-	-	-	58	39	108	90	-	-	-	-	-	-
	100 LG	4; 6	-	-	-	-	55	38	105	88	75	53	125	103	-	-
	112 M	2	38	25	88	75	-	-	-	-	-	-	-	-	-	-
	112 MG	2; 6	37	24	87	74	-	-	-	-	126	104	76	54	-	-
	112 MU	4; 6	-	-	-	-	54	36	114	96	66	45	126	105	-	-
	132 S	2; 6	69	49	129	109	-	-	-	-	124	93	184	153	-	-
	132 SU	2; 4	65	46	125	106	99	73	159	133	-	-	-	-	-	-
	132 SM/M	2; 4; 6	101	74	171	144	148	111	218	181	178	134	248	204	-	-
	132 MU	4; 6	-	-	-	-	139	103	219	183	168	124	248	204	-	-
	160 MP	2	140	104	220	184	-	-	-	-	-	-	-	-	-	-
	160 MR	2; 4	131	95	221	185	193	145	283	235	-	-	-	-	-	-
	160 M	2; 4; 6	132	96	232	196	187	140	287	240	235	179	335	279	-	-
	160 MU	6	-	-	-	-	-	-	-	-	219	164	319	264	-	-
	160 L	2; 4; 6	128	96	228	196	183	136	283	236	231	175	331	275	-	-
	160 LUR	4; 6	-	-	-	-	213	159	313	259	257	193	357	293	-	-
	180 M	4	-	-	-	-	228	174	291	237	-	-	-	-	-	-
	180 MR	2	156	115	256	215	-	-	-	-	-	-	-	-	-	-
	180 MT	2; 4	159	118	259	218	214	160	314	260	-	-	-	-	-	-
	180 L	6	-	-	-	-	-	-	-	-	265	201	328	264	-	-
	180 LR	4	-	-	-	-	203	150	303	250	-	-	-	-	-	-
	180 LUR	4; 6	-	-	-	-	224	170	287	233	224	162	287	225	-	-
	200 L	2; 6	244	190	310	256	-	-	-	-	362	278	428	344	-	-
	200 LR	2; 4; 6	244	191	307	254	312	241	375	304	341	258	404	321	-	-
	200 LU	4; 6	-	-	-	-	316	245	379	308	327	245	390	308	-	-
	225 SG	4	-	-	-	-	411	321	481	391	-	-	-	-	-	-
	225 SR	4	-	-	-	-	350	271	420	341	-	-	-	-	-	-
	225 ST	4	-	-	-	-	372	292	438	358	-	-	-	-	-	-
	225 MG	4; 6	-	-	-	-	407	317	477	387	535	426	605	496	-	-
	225 MR	2; 4; 6	280	220	343	283	358	278	421	341	409	315	472	378	-	-
	225 MT	2	281	221	347	287	-	-	-	-	-	-	-	-	-	-
	250 ME	4; 6	-	-	-	-	400	311	470	381	471	365	541	435	-	-
	250 MZ	2	277	217	340	280	-	-	-	-	-	-	-	-	-	-
	280 SC	2; 6	303	236	373	306	-	-	-	-	461	355	531	425	-	-
	280 SD	4	-	-	-	-	454	349	542	437	-	-	-	-	-	-
	280 MC	2	300	233	370	303	-	-	-	-	-	-	-	-	-	-
280 MD	4; 6	-	-	-	-	446	342	534	430	524	401	612	489	-	-	
315 SN	2	357	279	427	349	-	-	-	-	-	-	-	-	-	-	
315 SP	4; 6	-	-	-	-	814	671	634	491	950	780	770	600	-	-	
315 MP	2; 4; 6	487	405	307	225	768	628	588	448	917	749	737	569	-	-	
315 MR	4; 6	-	-	-	-	770	630	590	450	864	699	684	519	-	-	

IMfinity® 3-phase induction motors - High efficiency & Premium efficiency

IP55 aluminium frame

Construction

Axial loads

VERTICAL MOTOR SHAFT FACING DOWN

For a bearing life L_{10h} of 25,000 hours and 40,000 hours

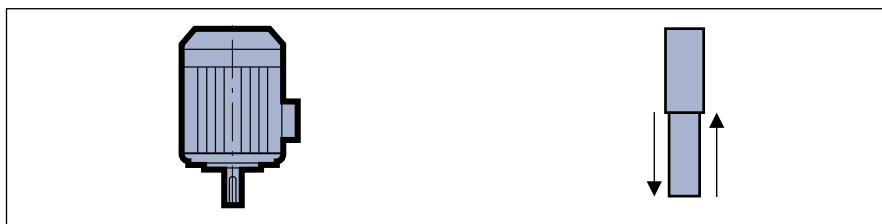

Series	Type	No. of poles	Permissible axial load (in daN) on main shaft extension for standard bearing assembly											
			3000 min ⁻¹				1500 min ⁻¹				1000 min ⁻¹			
			25 000 hours	40 000 hours	25 000 hours	40 000 hours	25 000 hours	40 000 hours	25 000 hours	40 000 hours	25 000 hours	40 000 hours	25 000 hours	40 000 hours
IM V5 IM V1/V15 IM V18/V58														
LSES	80 L	2	29	20	63	54	-	-	-	-	-	-	-	-
	80 LG	2; 4	26	16	72	62	45	32	93	78	-	-	-	-
	90 SL/L	2; 4; 6	26	16	73	63	42	28	91	78	53	37	101	86
	90 LU	2; 4; 6	19	9	77	67	33	20	95	82	43	28	105	89
	100 L	2; 6	38	24	98	85	-	-	-	-	73	52	137	115
	100 LR	4	-	-	-	-	52	34	117	99	-	-	-	-
	100 LG	4; 6	-	-	-	-	48	31	116	99	68	46	137	115
	112 M	2	35	21	95	81	-	-	-	-	-	-	-	-
	112 MG	2; 6	31	18	98	85	-	-	-	-	68	47	138	116
	112 MU	4; 6	-	-	-	-	45	28	128	110	57	36	140	119
	132 S	2; 6	61	41	142	122	-	-	-	-	115	84	200	169
	132 SU	2; 4	57	37	139	120	90	63	176	149	-	-	-	-
	132 SM/M	2; 4; 6	90	62	189	161	137	100	237	200	165	121	270	226
	132 MU	4; 6	-	-	-	-	125	89	242	206	152	108	273	230
	160 MP	2	126	90	243	207	-	-	-	-	-	-	-	-
	160 MR	2; 4	115	80	246	210	175	127	311	264	-	-	-	-
	160 M	2; 4; 6	111	75	264	229	164	117	326	278	210	154	375	319
	160 MU	6	-	-	-	-	-	-	-	-	189	133	375	319
	160 L	2; 4; 6	106	70	263	228	160	113	322	274	208	151	371	314
	160 LUR	4; 6	-	-	-	-	186	131	363	309	227	162	417	352
	180 M	4	-	-	-	-	187	132	361	306	-	-	-	-
	180 MR	2	131	90	296	255	-	-	-	-	-	-	-	-
	180 MT	2; 4	136	95	295	254	189	134	360	305	-	-	-	-
	180 L	6	-	-	-	-	-	-	-	-	226	161	398	334
	180 LR	4	-	-	-	-	177	122	355	300	-	-	-	-
	180 LUR	4; 6	-	-	-	-	187	132	355	300	183	120	377	314
	200 L	2; 6	194	139	384	330	-	-	-	-	308	223	524	439
	200 LR	2; 4; 6	209	154	360	306	275	203	445	373	299	215	496	412
	200 LU	4; 6	-	-	-	-	262	190	471	398	269	186	505	422
	225 SG	4	-	-	-	-	335	244	616	524	-	-	-	-
	225 SR	4	-	-	-	-	294	213	520	439	-	-	-	-
	225 ST	4	-	-	-	-	322	241	519	438	-	-	-	-
	225 MG	4; 6	-	-	-	-	324	232	621	530	456	345	749	638
	225 MR	2; 4; 6	234	173	413	352	302	221	520	439	348	253	587	492
	225 MT	2	240	179	410	349	-	-	-	-	-	-	-	-
	250 ME	4; 6	-	-	-	-	305	214	632	541	378	270	712	604
	250 MZ	2	228	168	417	356	-	-	-	-	-	-	-	-
	280 SC	2; 6	233	165	488	420	-	-	-	-	348	240	728	621
	280 SD	4	-	-	-	-	340	233	738	632	-	-	-	-
	280 MC	2	221	153	496	428	-	-	-	-	-	-	-	-
280 MD	4; 6	-	-	-	-	319	213	745	639	391	265	853	728	
315 SN	2	268	188	571	491	-	-	-	-	-	-	-	-	
315 SP	4; 6	-	-	-	-	620	475	923	778	748	575	1074	901	
315 MP	2; 4; 6	333	249	541	456	541	397	959	815	695	524	1088	917	
315 MR	4; 6	-	-	-	-	537	393	966	822	591	420	1151	981	

IMfinity® 3-phase induction motors - High efficiency & Premium efficiency

IP55 aluminium frame

Construction

Axial loads

VERTICAL MOTOR SHAFT FACING UP

For a bearing life L_{10h} of 25,000 hours and 40,000 hours

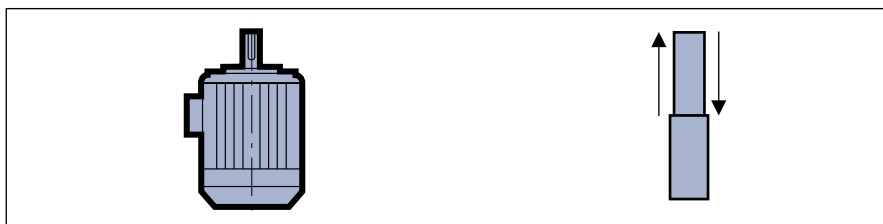

Series	Type	No. of poles	Permissible axial load (in daN) on main shaft extension for standard bearing assembly											
			3000 min ⁻¹				1500 min ⁻¹				1000 min ⁻¹			
			25 000 hours	40 000 hours	25 000 hours	40 000 hours	25 000 hours	40 000 hours	25 000 hours	40 000 hours	25 000 hours	40 000 hours	25 000 hours	40 000 hours
IM V6 IM V3/V36 IM V19/V69														
LSES	80 L	2	59	50	33	24	-	-	-	-	-	-	-	-
	80 LG	2; 4	66	56	32	22	85	71	53	39	-	-	-	-
	90 SL/L	2; 4; 6	66	56	33	23	82	68	51	38	93	77	61	46
	90 LU	2; 4; 6	69	59	27	18	83	70	45	32	93	77	54	39
	100 L	2; 6	88	74	48	35	-	-	-	-	123	102	87	65
	100 LR	4	-	-	-	-	102	84	67	49	-	-	-	-
	100 LG	4; 6	-	-	-	-	98	81	67	49	118	96	87	66
	112 M	2	84	71	45	31	-	-	-	-	-	-	-	-
	112 MG	2; 6	81	68	48	35	-	-	-	-	118	97	88	66
	112 MU	4; 6	-	-	-	-	105	88	68	50	117	96	80	60
	132 S	2; 6	121	101	82	62	-	-	-	-	175	143	140	109
	132 SU	2; 4	117	97	79	60	150	123	116	89	-	-	-	-
	132 SM/M	2; 4; 6	160	132	119	91	207	170	167	130	235	191	200	156
	132 MU	4; 6	-	-	-	-	206	169	163	126	232	188	193	150
	160 MP	2	206	170	163	127	-	-	-	-	-	-	-	-
	160 MR	2; 4	205	170	156	120	265	217	222	174	-	-	-	-
	160 M	2; 4; 6	211	175	164	129	264	217	226	178	310	254	275	219
	160 MU	6	-	-	-	-	-	-	-	-	289	233	275	219
	160 L	2; 4; 6	206	170	163	128	260	213	222	174	308	251	271	214
	160 LUR	4; 6	-	-	-	-	286	231	263	209	327	262	317	252
	180 M	4	-	-	-	-	250	195	298	243	-	-	-	-
	180 MR	2	231	190	196	155	-	-	-	-	-	-	-	-
	180 MT	2; 4	236	195	195	154	289	234	260	205	-	-	-	-
	180 L	6	-	-	-	-	-	-	-	-	289	224	335	271
	180 LR	4	-	-	-	-	277	222	255	200	-	-	-	-
	180 LUR	4; 6	-	-	-	-	250	195	292	237	246	183	314	251
	200 L	2; 6	260	205	318	264	-	-	-	-	374	289	458	373
	200 LR	2; 4; 6	272	217	297	243	338	266	382	310	362	278	433	349
	200 LU	4; 6	-	-	-	-	325	253	408	335	332	249	442	359
	225 SG	4	-	-	-	-	405	314	546	454	-	-	-	-
	225 SR	4	-	-	-	-	364	283	450	369	-	-	-	-
	225 ST	4	-	-	-	-	388	307	453	372	-	-	-	-
	225 MG	4; 6	-	-	-	-	394	302	551	460	526	415	679	568
	225 MR	2; 4; 6	297	236	350	289	365	284	457	376	411	316	524	429
	225 MT	2	306	245	344	283	-	-	-	-	-	-	-	-
	250 ME	4; 6	-	-	-	-	375	284	562	471	448	340	642	534
	250 MZ	2	291	231	354	293	-	-	-	-	-	-	-	-
	280 SC	2; 6	303	235	418	350	-	-	-	-	418	310	658	551
	280 SD	4	-	-	-	-	428	321	650	544	-	-	-	-
	280 MC	2	291	223	426	358	-	-	-	-	-	-	-	-
280 MD	4; 6	-	-	-	-	407	301	657	551	479	353	765	640	
315 SN	2	338	258	501	421	-	-	-	-	-	-	-	-	
315 SP	4; 6	-	-	-	-	440	295	1103	958	568	395	1254	1081	
315 MP	2; 4; 6	153	69	721	636	361	217	1139	995	515	344	1268	1097	
315 MR	4; 6	-	-	-	-	357	213	1146	1002	411	240	1331	1161	

IP55 ALUMINIUM MOTORS

STANDARD FITTING ARRANGEMENT

Permissible radial load on main shaft extension with a bearing life L_{10h} of 25,000 hours.

FR: Radial Force

X: Distance with respect to the shaft shoulder

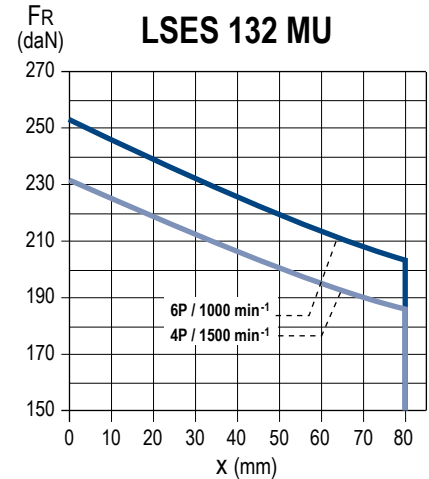
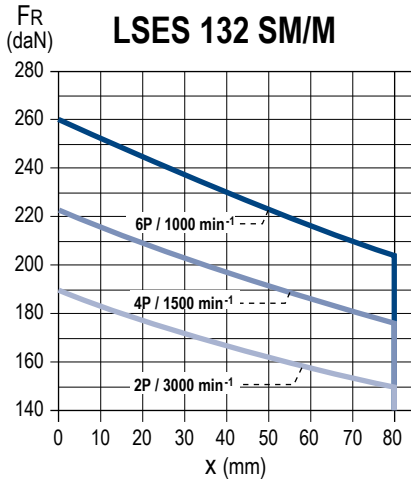
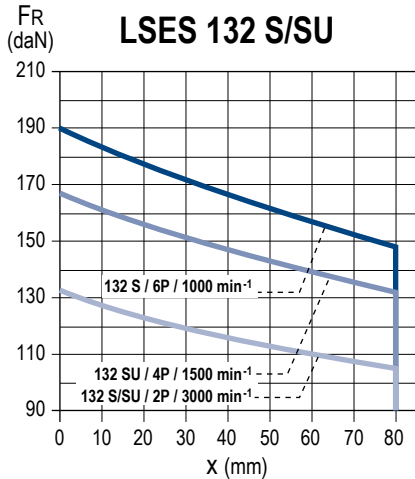
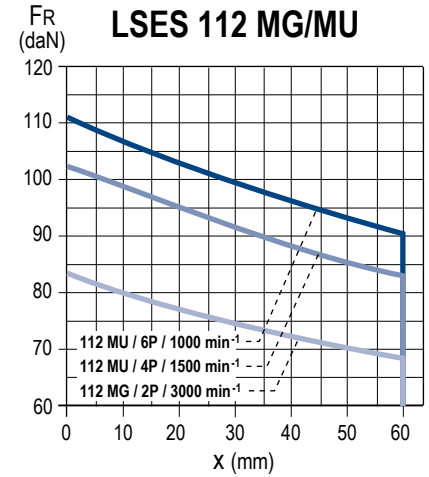
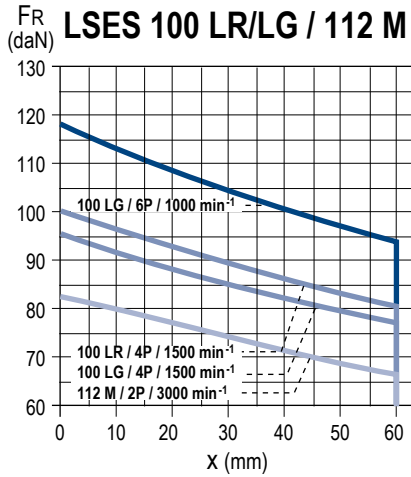
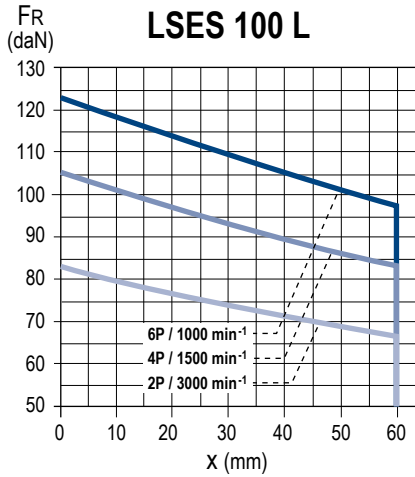
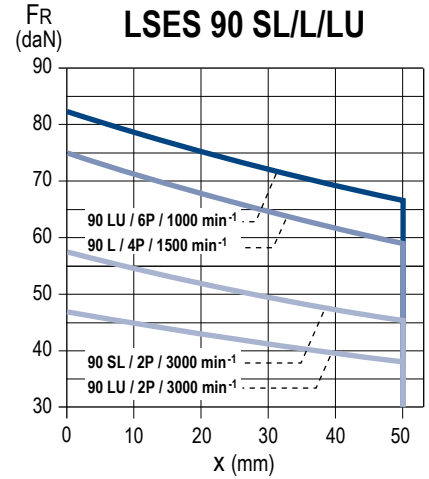
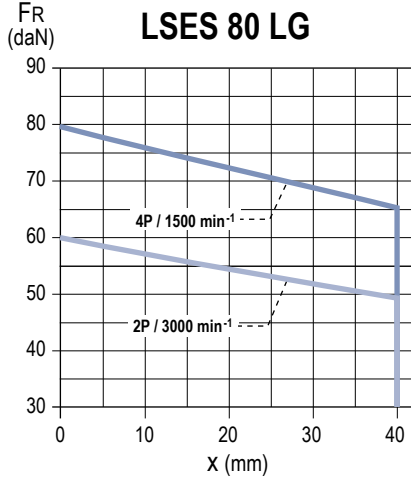
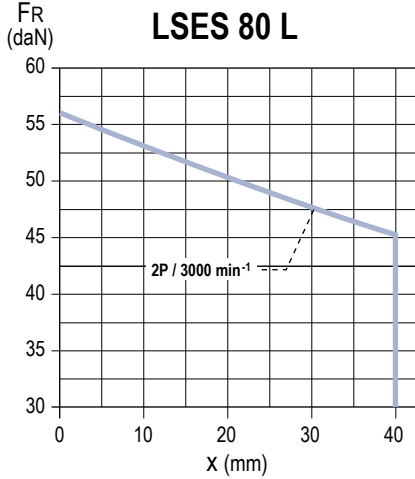

IMfinity® 3-phase induction motors - High efficiency & Premium efficiency

IP55 aluminium frame

Construction

Radial loads

STANDARD FITTING ARRANGEMENT

Permissible radial load on main shaft extension with a bearing life L_{10h} of 25,000 hours.

FR: Radial Force

X: Distance with respect to the shaft shoulder

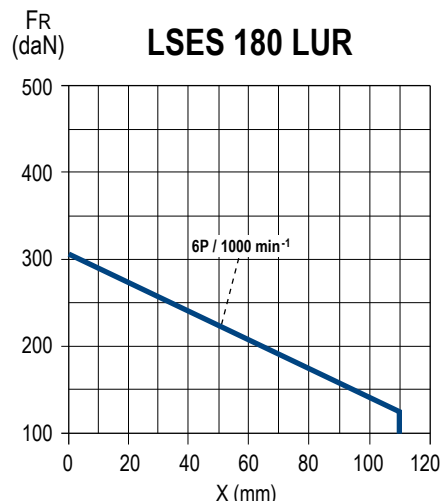
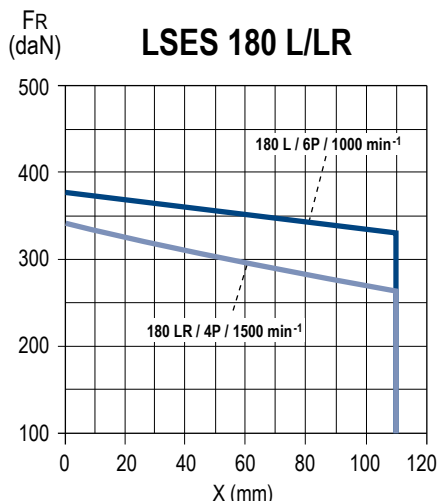
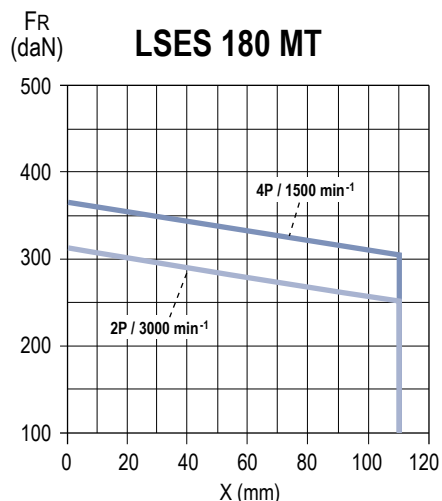
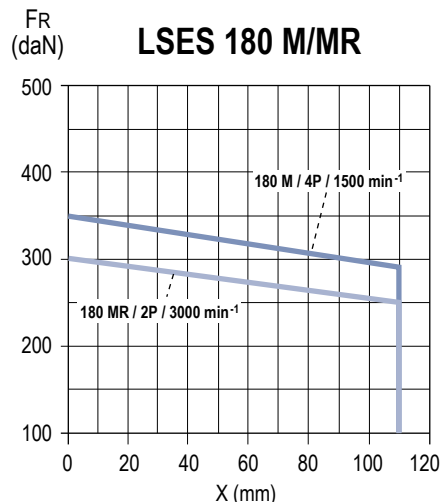
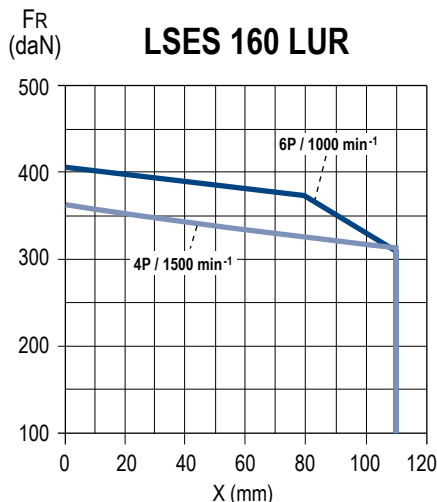
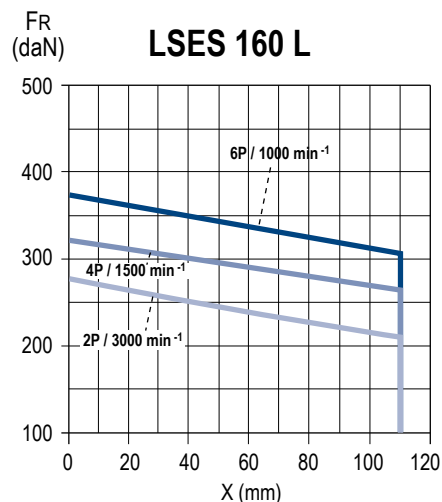
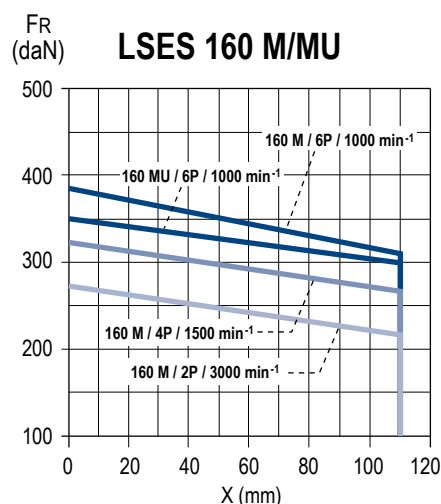
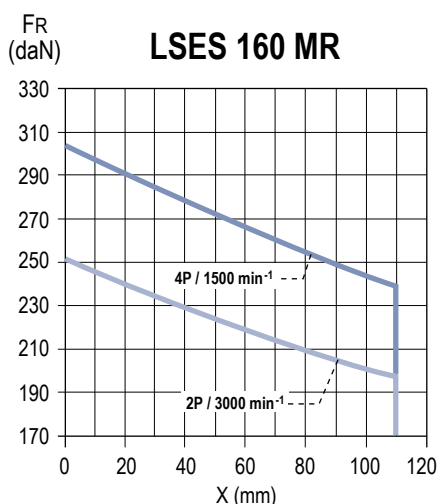
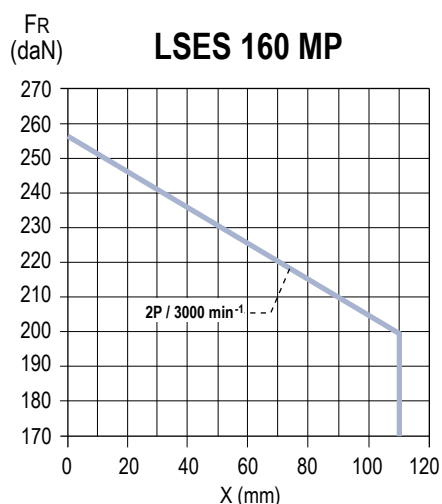

IMfinity® 3-phase induction motors - High efficiency & Premium efficiency

IP55 aluminium frame

Construction

Radial loads

STANDARD FITTING ARRANGEMENT

Permissible radial load on main shaft extension with a bearing life L_{10h} of 25,000 hours.

FR: Radial Force

X: Distance with respect to the shaft shoulder

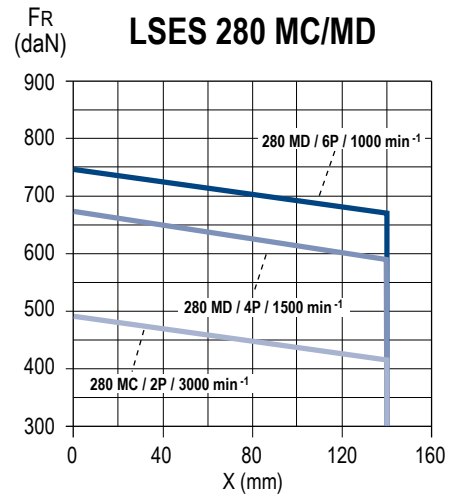
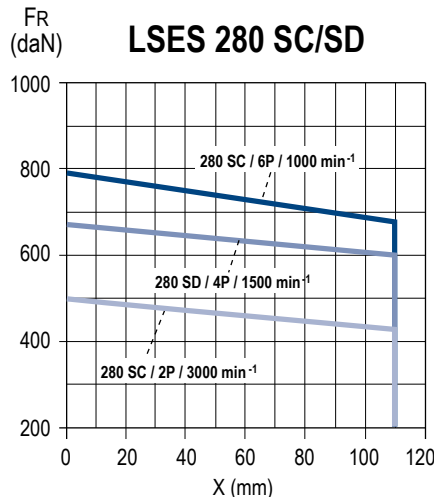
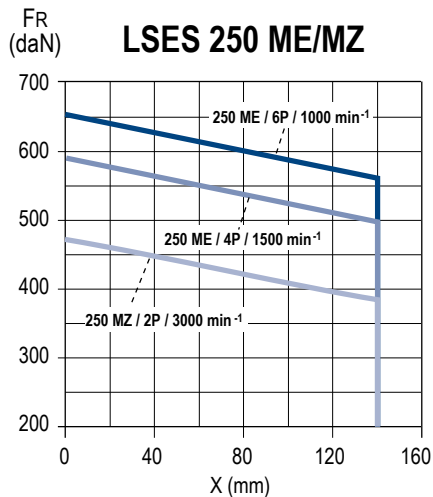
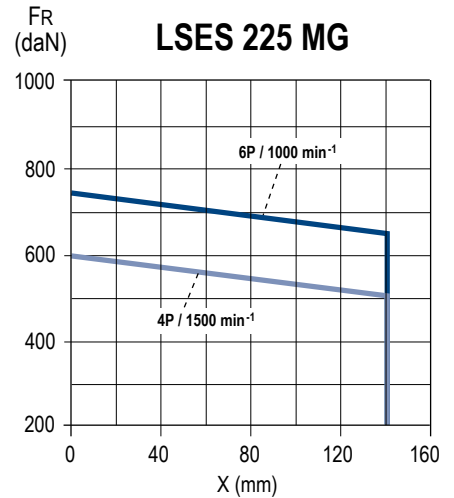
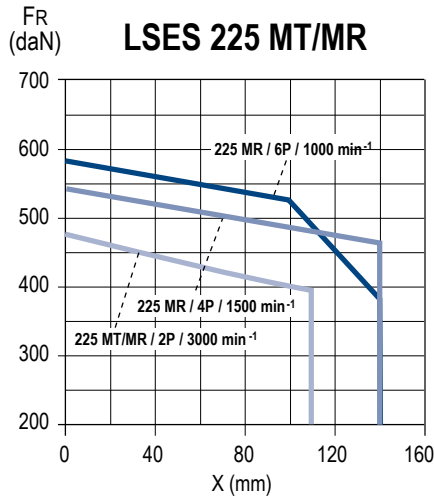
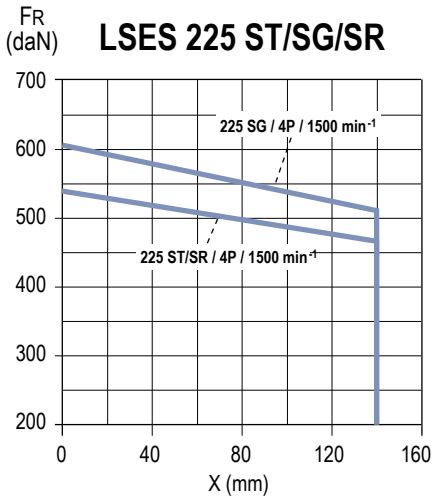
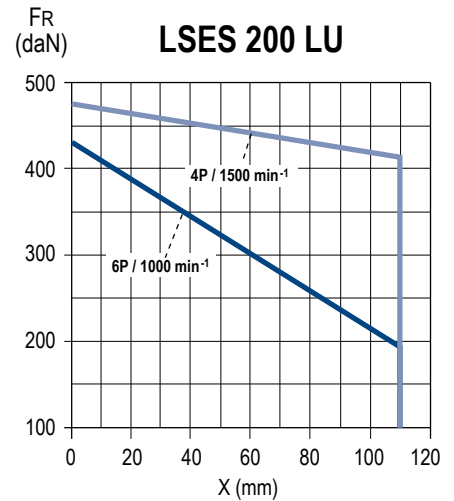
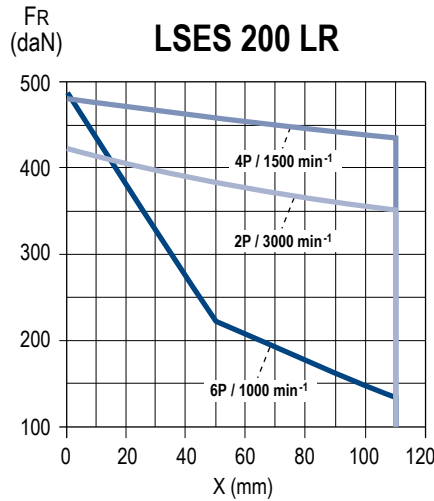
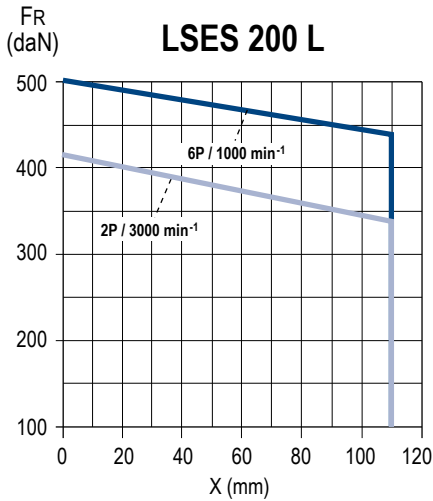

IMfinity® 3-phase induction motors - High efficiency & Premium efficiency

IP55 aluminium frame

Construction

Radial loads

STANDARD FITTING ARRANGEMENT

Permissible radial load on main shaft extension with a bearing life L_{10h} of 25,000 hours.

FR: Radial Force

X: Distance with respect to the shaft shoulder

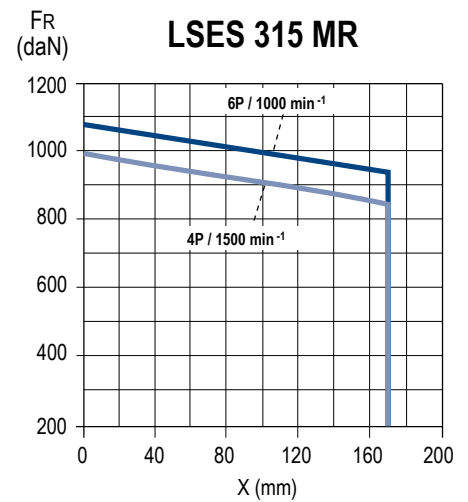
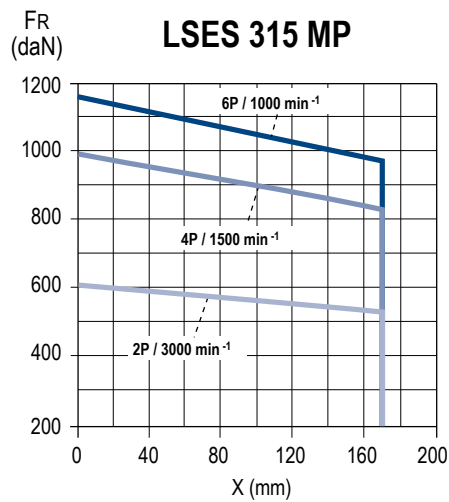
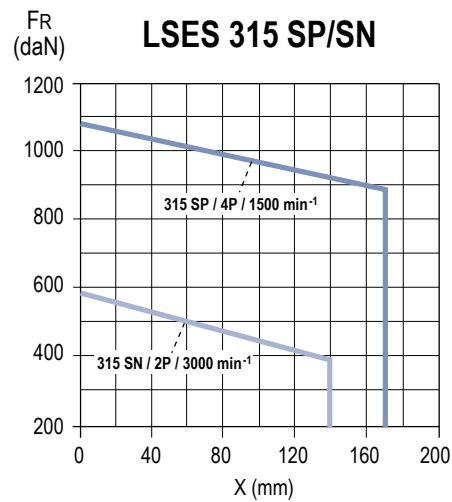

IMfinity® 3-phase induction motors - High efficiency & Premium efficiency

IP55 aluminium frame

Construction

Radial loads

SPECIAL FITTING ARRANGEMENT

Type of drive end roller bearings

Series	Type	No. of poles	Non drive end bearing (N.D.E.)	Drive end bearing (D.E.)
LSES	160 M/MU	4; 6	6210 C3	NU 309
	160 L			
	180 MT	4	6210 C3	NU 310
	180 LR			
	180 LUR	4; 6	6312 C3	NU 310
	180 M	4	6212 C3	NU 310
	180 L	6		
	200 L	6	6214 C3	NU 312
	200 LR	4; 6	6312 C3	NU 312
	200 LU			
	225 ST	4	6214 C3	NU 313
	225 SR/MR	4; 6	6312 C3	NU 313
	225 SG	4	6216 C3	NU 314
	225 MG	4; 6		
	250 ME	4; 6	6216 C3	NU 314
	280 SC	6	6216 C3	NU 316
	280 SD/MD	4; 6	6218 C3	NU 316
	315 SP	4	6317 C3	NU 320
315 MP/MR	4; 6			

IMfinity® 3-phase induction motors - High efficiency & Premium efficiency

IP55 aluminium frame

Construction

Radial loads

SPECIAL FITTING ARRANGEMENT

Permissible radial load on main shaft extension with a bearing life L_{10h} of 25,000 hours.

FR: Radial Force

X: Distance with respect to the shaft shoulder

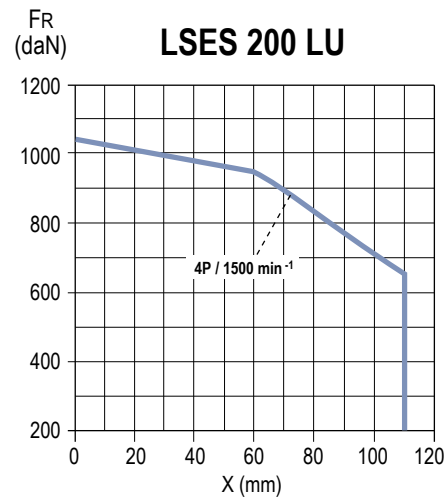
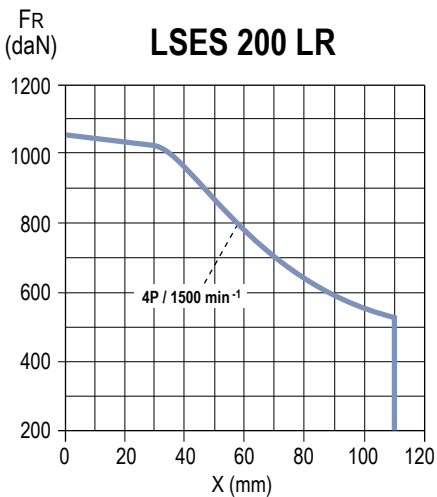
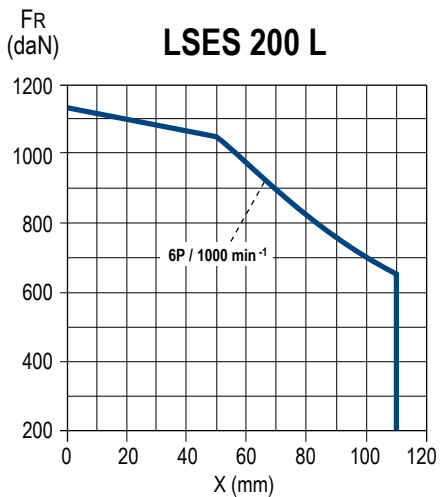
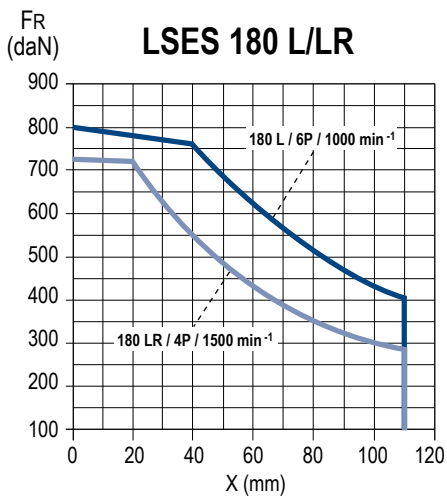
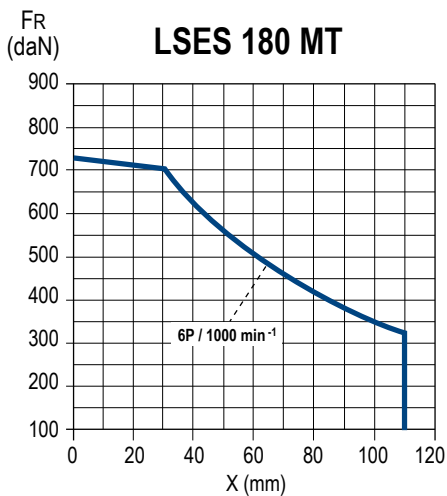
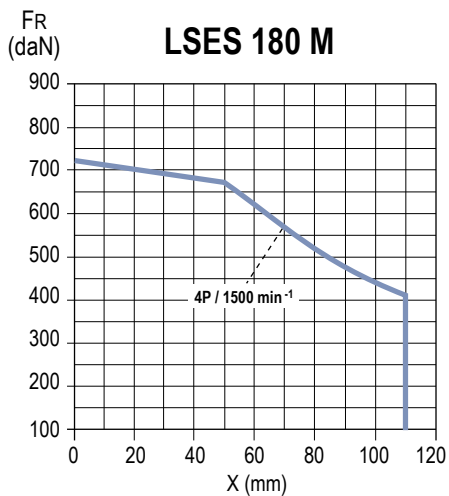
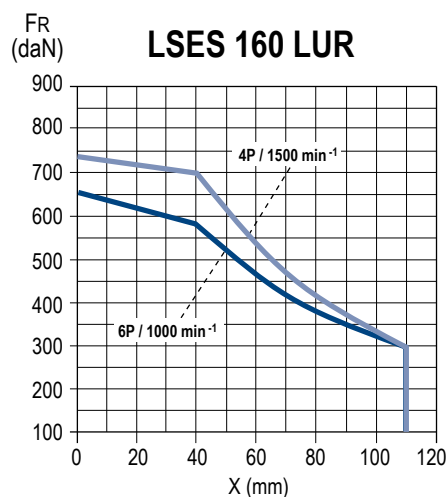
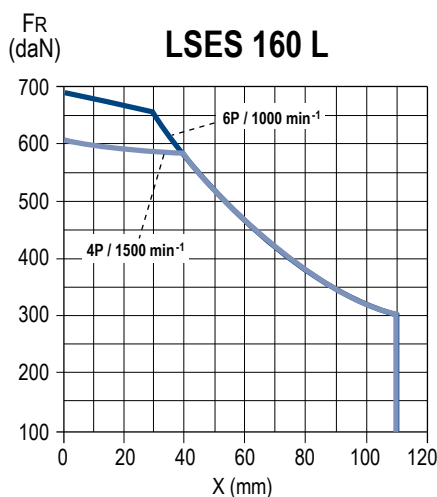
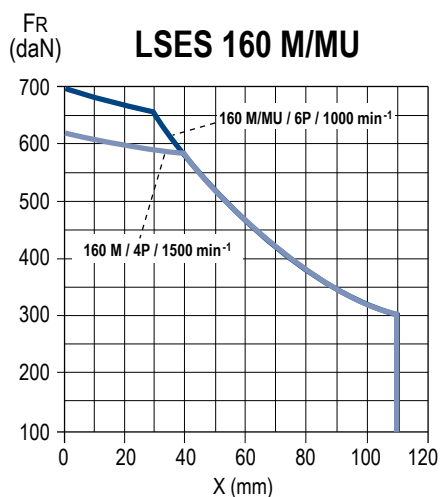

IMfinity® 3-phase induction motors - High efficiency & Premium efficiency

IP55 aluminium frame

Construction

Radial loads

SPECIAL FITTING ARRANGEMENT

Permissible radial load on main shaft extension with a bearing life L_{10h} of 25,000 hours.

FR: Radial Force

X: Distance with respect to the shaft shoulder

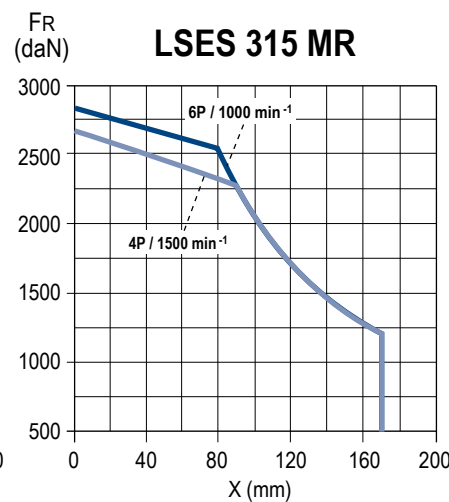
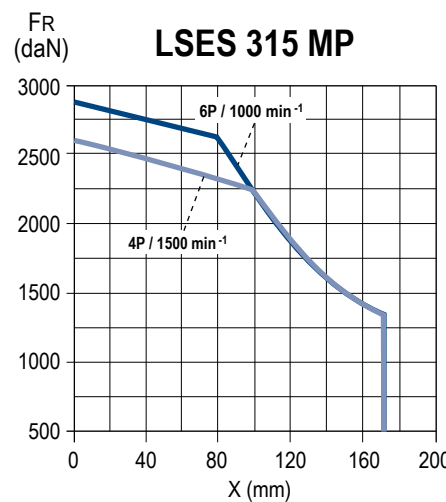
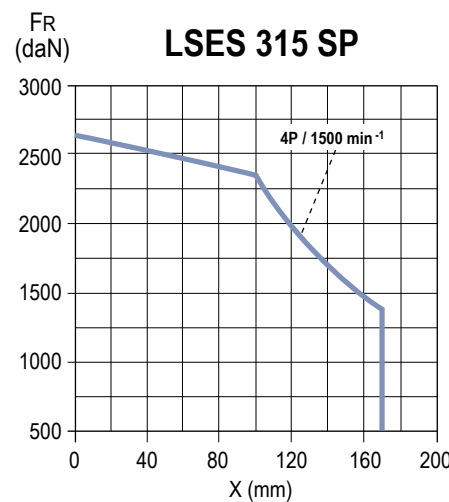
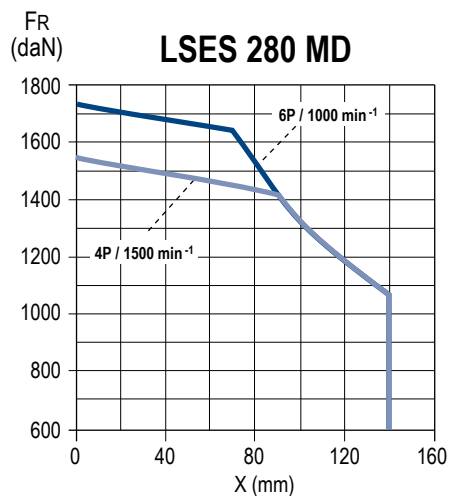
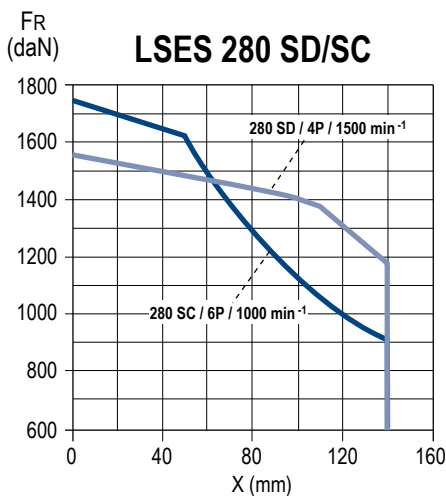
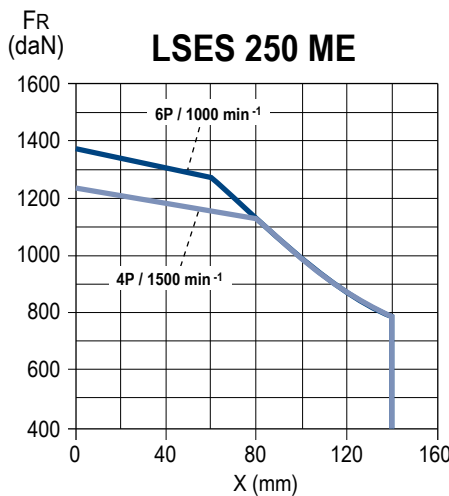
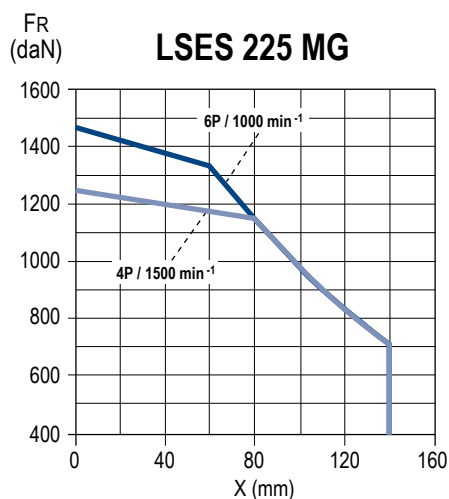
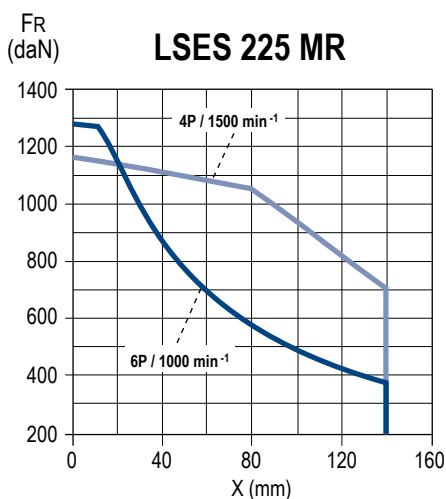
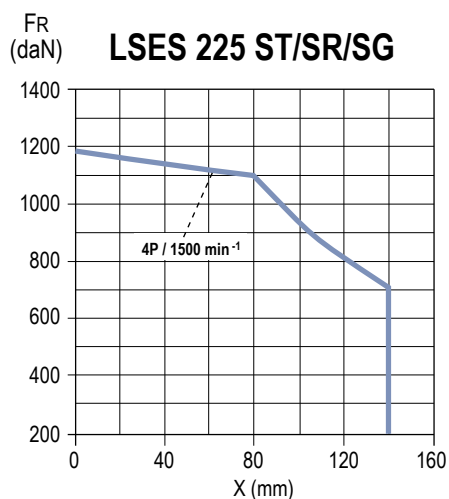

IMfinity® 3-phase induction motors - High efficiency & Premium efficiency

IP55 aluminium frame

Optional features

Non-standard flanges

Optionally, Leroy-Somer motors can be fitted with flanges and faceplates that are larger or smaller than standard. This means that motors can be adapted to all types of situation without the need for costly and time-consuming modifications.

The tables below give the flange and faceplate dimensions and also indicate flange/motor compatibility.

The bearing and shaft extension for each frame size remain standard.

Dimensions in millimetres

(FF) Flange mounted

IEC symbol	Flange dimensions						
	M	N	P	T	n	S	LA
FF 100	100	80	120	2.5	4	7	5
FF 115	115	95	140	3	4	10	10
FF 130	130	110	160	3.5	4	10	10
FF 165	165	130	200	3.5	4	12	10
FF 215	215	180	250	4	4	15	12
FF 265	265	230	300	4	4	15	14
FF 300	300	250	350	5	4	18.5	14
FF 350	350	300	400	5	4	18.5	15
FF 400	400	350	450	5	8	18.5	16
FF 500	500	450	550	5	8	18.5	18
FF 600*	600	550	660	6	8	24	22

* Tolerance N js6

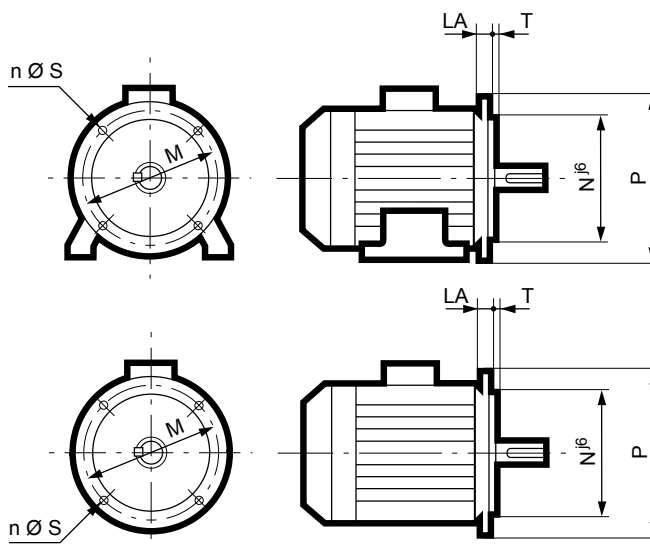

(FT) Face mounted

IEC symbol	Faceplate dimensions					
	M	N	P	T	n	M.S
FT 65	65	50	80	2.5	4	M5
FT 75	75	60	90	2.5	4	M5
FT 85	85	70	105	2.5	4	M6
FT 100	100	80	120	3	4	M6
FT 115	115	95	140	3	4	M8
FT 130	130	110	160	3.5	4	M8
FT 165	165	130	200	3.5	4	M10
FT 215	215	180	250	4	4	M12
FT 265	265	230	300	4	4	M12

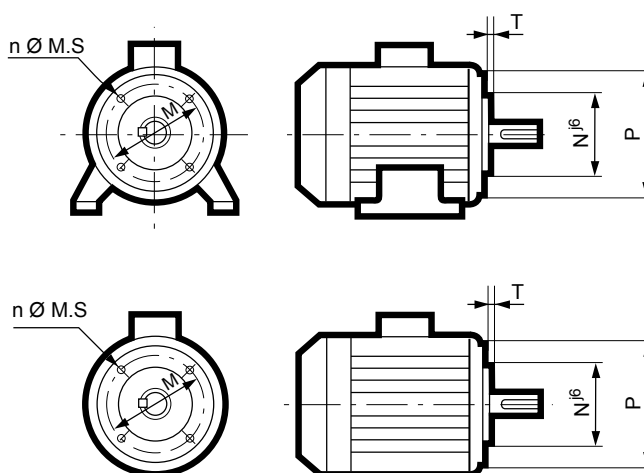

IMfinity® 3-phase induction motors - High efficiency & Premium efficiency

IP55 aluminium frame

Optional features

Mechanical options

MODIFIED FLANGES

Motor type	Flange type Mounting forms	(FF) Flange mounted											(FT) Face mounted										
		FF 85	FF 100	FF 115	FF 130	FF 165	FF 215	FF 265	FF 300	FF 350	FF 400	FF 500	FF 600	FT 65	FT 75	FT 85	FT 100	FT 115	FT 130	FT 165	FT 215	FT 265	
80 L	all	■	■	■	■	●	◆							◆	◆	◆	●	◆	◆				
80 LG / 90	B5/B35 ⁽¹⁾	◆	◆	◆	◆	●	◆	■								◆	◆	●	■	◆	■		
80 LG / 90	B3/B14/B34	■	■	■	■	■	■	■								◆	◆	●	◆	◆	■		
100 L/LR	all	■	■	■	■	■	●	■								◆	◆	◆	●	◆	◆	◆	
100 LG	all				■	■	●	◆									◆	●	◆	◆	◆	◆	
112 M/MR	all	■	■	■	■	■	●	■								◆	◆	◆	●	◆	◆	◆	
112 MG/MU	all				■	■	●	◆									◆	●	◆	◆	◆	◆	
132 S/SU	all					■	◆	●											◆	◆	◆	●	
132 SM/M/MU	all					■	■	●	◆										■	■	●	●	
160 MR/LR/MP	all						◆	■	●	■												●	
160 M/L/LU/LUR	all						◆	●	◆													●	
180	all							●	●	◆	◆ ⁽¹⁾												
200	all							●	●	◆													
225	all									●	◆												
250	all									◆	●												
280	all									◆	●	◆											
315	all										◆ ⁽¹⁾	●											

● Standard ■ Adapted shaft ◆ Adaptable without shaft modifications ⁽¹⁾ Dimension C need not comply with IEC 60072

DRIP COVER FOR OPERATION IN VERTICAL POSITION, SHAFT END FACING DOWN

Dimensions in millimetres

Motor type	LB'	Ø
LSES 80	LB + 20	145
LSES 90	LB + 20	185
LSES 100	LB + 20	185
LSES 112 MR	LB + 20	185
LSES 112 MG/MU	LB + 25	210
LSES 132 S/SU	LB + 25	210
LSES 132 M/MU	LB + 30	240
LSES 160 MP/LR	LB + 30	240
LSES 160 M/L/LU	LB + 36.5	265
LSES 180 MT/LR	LB + 36.5	265
LSES 180 L	LB + 36.5	305
LSES 200 LR	LB + 36.5	305
LSES 200 L	LB + 36.5	350
LSES 225	LB + 36.5	350
LSES 250 MZ	LB + 36.5	350
LSES 250 ME	LB + 55	420
LSES 280	LB + 55	420
LSES 315 SN	LB + 55	420
LSES 315 SP/MP/MR	LB + 76.5	505

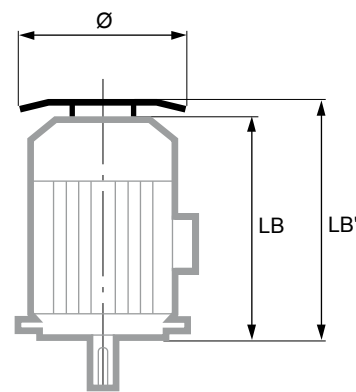

IMfinity® 3-phase induction motors - High efficiency & Premium efficiency

IP55 aluminium frame

Optional features

Mechanical and electrical options

BRAKE MOTORS, FORCED VENTILATION

The integration of high-efficiency motors within a process often requires accessories to make operation easier:

- Forced ventilation for motors used at high or low speeds.
- Holding brakes for maintaining the rotor in the stop position without needing to leave the motor switched on.
- Emergency stop brakes to immobilise loads in case of failure of the motor torque control or loss of power supply.

Notes:

- Without forced ventilation, there is a possibility of overspeed with optional class B balancing.
- The motor temperature is monitored by sensors built into the windings.

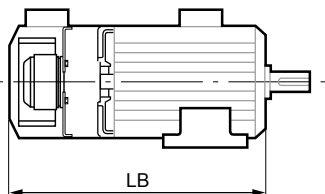

LSES series	LB dimensions with Forced Ventilation	
	Foot or face mounted motors	Flange mounted motor
80 L		317
80 LG	331	351
90 S	304	324
90 L	331	351
100 L		
100 LR		373
112 MR		
112 MG		412
112 MU		
132 S		453
132 SU		
132 M		458
132 MU		
160 MP		709
160 MR		730
160 L		
160 M		687
180 MT		
180 LR		702
180 L		741
200 LR		796
200 L		802
225 MR		853.5
225 ST		
225 MT		808.5
250 ME		1012
250 MZ		853.5
280 MD		1072
280 SC		
280 MC		1012
315 SN		1072
315 SP		
315 MP		1181
315 MR		1251

MOTORS WITH SPACE HEATERS

Type	Power (W)
LSES 80 L	16
LSES 80 LG to 160 MP/LR	25
LSES 160 M/L to 225 ST/MT/MR	52
LSES 250 MZ	
LSES 250 ME/MF	
LSES 280 SC/MC/MD	84
LSES 315 SN	
LSES 315 MP/MR	108

The space heaters use 200/240 V single-phase, 50 or 60 Hz.

MOTORS WITH REMOVABLE CONNECTOR

The removable connector option allows quick, safe and simple motor connection.

It can be used in numerous processes (automotive, food industries, etc) where machine changeover times need to be kept to a minimum.

The male part of the connector is fitted instead of or on the motor terminal box, depending on which other options are selected. The connector socket is connected to the stator coils.

The female part of the connector is connected to the mains supply.

Up to 10 contacts can be mounted on the connectors, to cover power ratings up to 11 kW within an acceptable maximum current of 40 A.

For higher power ratings, please consult Leroy-Somer.



INTEGRATED VARIABLE SPEED MOTORS: VARMECA

Varmeca is a flux vector drive operating on all mains supplies (200 Volts to 480 Volts 50/60 Hz).

It is mounted instead of the terminal box in its position.

The drive allows low-speed operation at constant torque and high-speed operation at constant power (forced ventilation option mandatory). In all circumstances, the Varmeca can be used to manage PTC and PTO motor sensors.

The variable speed drive offers a decentralised solution on the machine, the product being designed to operate in industrial conditions (resin-encapsulated electronics).

Numerous options can be incorporated: local speed control, FWD and REV operation, display unit, braking resistor, fieldbus.

Varmeca complies with the European CE marking standards and North American standards, UL for the USA and c(UL)us for Canada.



IMfinity® 3-phase induction motors - High efficiency & Premium efficiency

IP55 aluminium frame

Installation and maintenance

Position of the lifting rings

LIFTING THE MOTOR ONLY (not coupled to the machine)

The regulations stipulate that over 25 kg, suitable handling equipment must be used.

All our motors are fitted with grab handles, making them easier to handle without risk. A diagram of the sling hoisting method appears below with the required dimensions.

To prevent any damage to the motor during handling (for example: switching the motor from horizontal to vertical), it is essential to follow these instructions.

HORIZONTAL POSITION

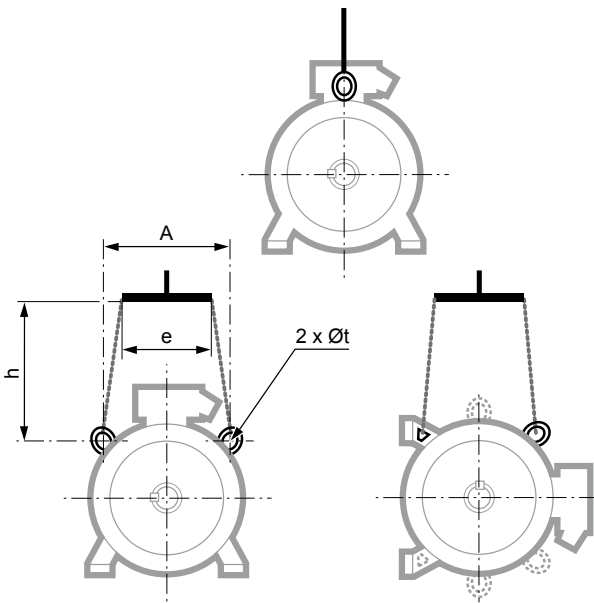

Type	Horizontal position			
	A	e min.	h min.	Øt
LSES 100 L/LR/LG	165	165	150	9
LSES 112 M/MR	165	165	150	9
LSES 112 MG/MU	-	-	-	9
LSES 132 S/SU	180	180	150	9
LSES 132 M/MU	200	180	150	14
LSES 160 MP/MR/LR	200	180	110	14
LSES 160 M/MU/L/LUR	200	260	150	14
LSES 180 M/MUR/L/LUR	200	260	150	14
LSES 200 L/LR	270	260	150	14
LSES 200 LU	270	260	150	14
LSES 225 SR/MR	270	260	150	14
LSES 225 S/SG/M/MG	360	380	200	30
LSES 250 MZ	360	380	200	30
LSES 250 ME	400	400	500	30
LSES 280 SC/SD/MC/MD	400	400	500	30
LSES 315 SN	400	400	500	30
LSES 315 SP/MP/MR	360	380	500	17

VERTICAL POSITION

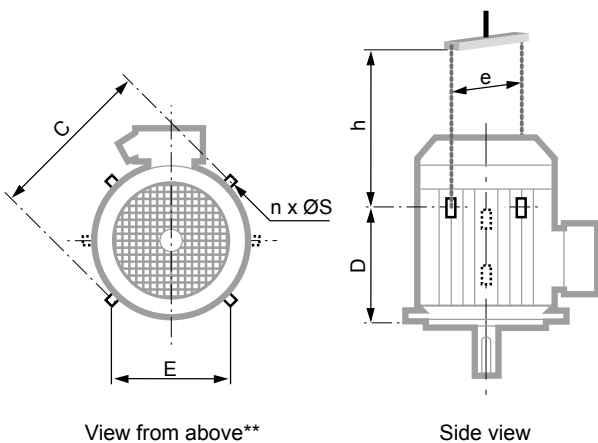

Type	Vertical position						
	C	E	D	n**	ØS	e min.*	h min.
LSES 160 M/MU/L/LUR	320	200	230	2	14	320	350
LSES 180 MR	320	200	230	2	14	320	270
LSES 180 M/L/LUR	390	265	290	2	14	390	320
LSES 200 L/LR	410	300	295	2	14	410	450
LSES 200 LU	410	300	295	2	14	410	450
LSES 225 SR/MR	480	360	405	4	30	540	350
LSES 225 S/SG/M/MG	480	360	405	4	30	500	500
LSES 250 MZ	480	360	405	4	30	590	550
LSES 250 ME	480	360	405	4	30	500	500
LSES 280 SC/SD/MC/MD	480	360	405	4	30	500	500
LSES 315 SN	480	360	405	4	30	500	500
LSES 315 SP/MP/MR	630	-	570	2	30	630	550

* if the motor is fitted with a drip cover, allow an additional 50 to 100 mm to avoid damaging it when the load is swung.

** if n = 2, the lifting rings form an angle of 90° with respect to the terminal box axis. If n = 4, this angle becomes 45°.

Separate ring ≤ 25 kg
Built-in ring > 25 kg

IMfinity® 3-phase induction motors - High efficiency & Premium efficiency IP55 Cast Iron frame

Contents

GENERAL INFORMATION	98-99
Designation.....	98
Description.....	99
ELECTRICAL AND MECHANICAL DATA	100 to 108
IE2 powered by the mains.....	100-101
IE2 powered by the drive.....	102-103
IE3 powered by the mains.....	104-105
IE3 powered by the drive.....	106-107
Mains connection.....	108
DIMENSIONS.....	109 to 114
Shaft extensions	109
Foot mounted IM 1001 (IM B3).....	110
Foot and flange mounted IM 2001 (IM B35).....	111
Flange mounted IM 3001 (IM B5) IM 3011 (IM V1).....	112
Foot and face mounted IM 2101 (IM B34).....	113
Face mounted IM 3601 (IM B14).....	114
CONSTRUCTION.....	115 to 126
Bearings and lubrication	115-116
Axial loads	117 to 119
Radial loads	120 to 126
OPTIONAL FEATURES	127 to 129
Non-standard flanges	127
Mechanical options.....	128
Mechanical and electrical options	129
INSTALLATION AND MAINTENANCE.....	130
Position of the lifting rings	130

IMfinity® 3-phase induction motors - High efficiency & Premium efficiency

IP55 Cast Iron frame

General information

Description



IP 55
Cl. F - $\Delta T 80 K$

The complete motor **reference** described below will enable you to **order** the desired equipment.

The selection method consists of following the terms in the designation.

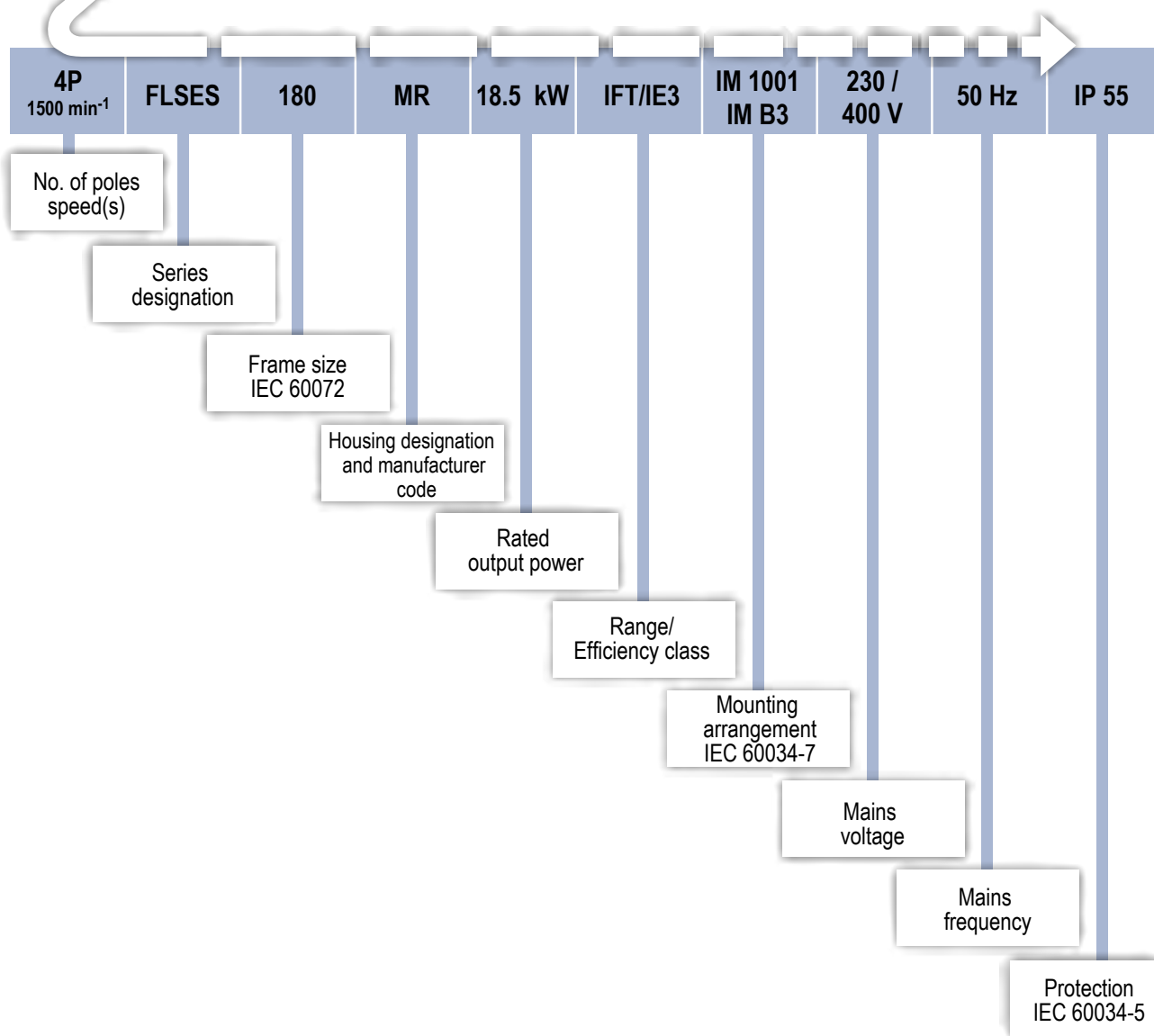

IMfinity® 3-phase induction motors - High efficiency & Premium efficiency

IP55 Cast Iron frame

General information

Description

Component	Materials	Remarks
Housing with cooling fins	Cast iron	- lifting rings for frame size ≥ 90 - earth terminal with an optional jumper screw
Stator	Insulated low-carbon magnetic steel laminations Electroplated copper	- low carbon content guarantees long-term lamination pack stability - welded laminations - semi-enclosed slots - class F insulation
Rotor	Insulated low-carbon magnetic steel laminations Aluminium	- inclined cage bars - rotor cage pressure die-cast in aluminium (or alloy for special applications). or soldered in copper. or keyed for soldered rotors - shrink-fitted to shaft - rotor balanced dynamically. class A. 1/2 key
Shaft	Steel	- for frame size ≤ 132 : • closed keyway - for frame size ≤ 160 : • tapped hole - for frame size ≥ 160 : • open keyway
End shields	Cast iron	
Bearings and lubrication		- permanently greased bearings frame size 80 to 225 - regreasable bearings frame size 250 to 450 - bearings preloaded at NDE up to 315 S. preloaded at DE from size 315 M upwards
Labyrinth seal Lipseals	Plastic or steel Synthetic rubber	- labyrinth seal at drive end for foot mounted motors. frame size ≤ 132 - lipseal at drive end for foot and flange mounted or flange mounted motors. frame size ≤ 132 - lipseal at drive end and non drive end for frame sizes 160 to 250 inclusive - decompression grooves for 280 M to 355 LD - labyrinth seal at drive end and non drive end for frame sizes ≥ 355 LK
Fan	Composite up to size 280 inclusive Metal from 315 ST upwards	- 2 directions of rotation: straight blades
Fan cover	Pressed steel	- fitted. on request. with a drip cover for operation in vertical position. shaft end facing down
Terminal box	Cast iron body and cover for all frame sizes	- IP 55 - fitted with a block with 6 terminals up to 355 LD. 6 or 12 terminals for frame sizes 355LK/400/450 - terminal box fitted with threaded plugs up to 132 - from the 160 to the 355. undrilled cable gland mounting plate (nozzle and cable gland as options) - 1 earth terminal in each terminal box

In the standard version. the motors are wound 400 V 50 Hz:

- power ratings ≤ 5.5 kW: Y connection
- power ratings ≥ 7.5 kW: connection Δ

Other construction types

CORROBLOC FINISH

The CORROBLOC finish is a top coat for the basic cast iron motor described above. In addition to the basic construction. its special finishes resist corrosion in particularly harsh environments. and these qualities are enhanced with age.

Component	Materials	Remarks
Stator - Rotor		- dielectric and anti-corrosion protection for frame sizes 80 to 132
Nameplate	Stainless steel	- nameplate: indelible marking
Screws	Stainless steel	- captive screws for terminal box cover (frame size ≤ 132)
Terminal box	Cast iron body and cover	
Cable gland	Brass	
External finish		- system IIIa (see External finish section)

IMfinity® 3-phase induction motors - High efficiency & Premium efficiency

IP55 Cast Iron frame

Electrical and mechanical characteristics

IE2 powered by the mains

Type	Rated power P _n kW	Rated torque M _n N.m	Starting torque/ Rated torque M _d /M _n	Maximum torque/ Rated torque M _m /M _n	Starting current/ Rated current I _d /I _n	Moment of inertia J kg.m ²	Weight IM B3 kg	Noise LP db(A)	400 V 50 Hz							
									Rated speed N _n min ⁻¹	Rated current I _n A	Efficiency IEC 60034-2-1 2007			Power factor		
											4/4	3/4	2/4	4/4	3/4	2/4
2 poles																
FLSES 80 L	0.75	2.5	2.7	3.2	6.3	0.00084	15.9	59	2845	1.6	79.8	80.8	79.3	0.86	0.79	0.67
FLSES 80 L	1.1	3.7	2.7	3.1	6.4	0.00095	16.2	60	2850	2.3	81.0	82.4	81.6	0.85	0.78	0.66
FLSES 90 SL	1.5	5	2.6	2.7	6.3	0.00201	22.8	67	2855	3	82.9	84.9	85.1	0.87	0.82	0.72
FLSES 90 L	2.2	7.4	2.6	2.8	6.4	0.00223	23.9	67	2855	4.4	83.5	85.4	85.6	0.86	0.8	0.68
FLSES 100 L	3	10	4.4	3.9	8.0	0.00297	31.9	67	2855	5.9	84.7	86.0	85.7	0.87	0.8	0.68
FLSES 112 MG	4	13.1	1.9	3.1	7.4	0.00822	42.2	66	2925	7.6	88.3	89.0	88.1	0.86	0.81	0.7
FLSES 132 SM	5.5	18	1.8	2.7	5.9	0.00898	66.6	66	2925	10.3	89.9	90.9	90.7	0.86	0.83	0.74
FLSES 132 SM	7.5	24.5	1.8	2.5	5.9	0.00974	69.4	67	2920	13.9	89.3	90.7	90.8	0.87	0.83	0.75
FLSES 132 M	9	29.4	1.9	2.8	6.5	0.01102	74.4	67	2925	16.8	90.3	91.5	91.7	0.86	0.83	0.74
FLSES 160 M	11	35.6	2.8	3.2	7.8	0.049	112	68	2950	20.3	90.8	91.3	90.9	0.86	0.82	0.74
FLSES 160 M	15	48.6	3.0	2.8	7.0	0.049	120	69	2945	26.7	91.2	92.0	92.1	0.89	0.87	0.81
FLSES 160 L	18.5	60.2	2.6	3.0	7.7	0.0551	129	69	2935	32.7	91.5	92.5	92.9	0.89	0.87	0.81
FLSES 180 M	22	71.5	3.0	3.1	8.0	0.1333	162	68	2940	39.3	92.0	93.0	93.2	0.88	0.86	0.79
FLSES 200 LU	30	97.1	2.1	3.1	7.2	0.2035	210	71	2950	53.9	92.6	93.0	92.7	0.87	0.84	0.77
FLSES 200 LU	37	120	2.1	3.4	6.9	0.1388	230	75	2945	65.2	93.0	93.6	93.5	0.88	0.86	0.80
FLSES 225 MR	45	146	2.6	3.4	8.1	0.1597	254	71	2952	80.6	93.5	94.1	94.1	0.86	0.84	0.78
FLSES 250 M	55	177	2.1	3.2	7.7	0.3356	378	79	2968	95.8	94.0	94.1	93.2	0.88	0.85	0.79
FLSES 280 S	75	241	2.1	2.7	7.0	0.48	565	79	2966	127	93.8	94.1	94.0	0.91	0.89	0.85
FLSES 280 M	90	290	2.2	2.8	7.4	0.57	615	80	2967	153	94.1	94.4	94.3	0.90	0.89	0.85
FLSES 315 S	110	353	1.9	2.7	7.6	1.17	940	82	2975	187	94.3	94.3	94.0	0.90	0.89	0.84
FLSES 315 M	132	424	2.0	2.4	7.6	1.25	1015	82	2975	223	94.6	94.6	94.3	0.90	0.89	0.84
FLSES 315 LA	160	514	2.0	2.9	7.6	1.34	1088	82	2975	274	94.8	94.8	94.5	0.89	0.87	0.83
FLSES 315 LB	200	642	2.0	2.4	7.7	1.45	1150	82	2973	337	95.0	95.0	94.7	0.90	0.88	0.84
FLSES 355 LA	250	802	2.9	2.8	6.9	3.02	1590	83	2978	428	95.0	95.0	94.7	0.88	0.86	0.80
FLSES 355 LB	315	1008	2.8	3.6	7.6	3.62	1740	84	2983	544	95.0	95.0	94.7	0.88	0.86	0.82
FLSES 355 LC	355	1137	2.5	3.2	7.2	3.64	1750	84	2981	620	95.0	95.0	94.7	0.87	0.85	0.81
FLSES 355 LD	400	1282	2.0	2.9	7.0	3.7	1770	84	2989	683	95.0	95.0	94.7	0.89	0.87	0.81
4 poles																
FLSES 80 LG	0.75	5	2.0	2.9	5.7	0.00265	20	45	1445	1.7	80.9	81.7	80.1	0.79	0.71	0.57
FLSES 90 SL	1.1	7.3	2.0	2.8	5.8	0.00336	22.3	51	1440	2.4	81.8	83.3	82.4	0.81	0.74	0.60
FLSES 90 L	1.5	10	2.4	2.9	6.7	0.00418	24.6	49	1440	3.2	83.0	84.5	84.1	0.82	0.75	0.62
FLSES 100 L	2.2	14.5	2.6	3.2	6.7	0.00567	33.2	50	1445	4.6	85.1	86.2	85.8	0.82	0.75	0.62
FLSES 100 LG	3	19.8	2.3	2.8	6.7	0	40	50	1450	6.1	86.3	87.6	87.3	0.83	0.75	0.62
FLSES 112 MU	4	26.3	2.0	2.8	6.2	0.01312	46.4	50	1450	7.9	87.4	89.1	89.6	0.84	0.79	0.69
FLSES 132 SM	5.5	36	2.5	3.2	7.4	0.01925	66.3	60	1458	10.7	88.6	89.7	89.5	0.83	0.77	0.65
FLSES 132 M	7.5	49.3	2.5	3.1	7.2	0.02286	71	60	1454	14.4	89.1	90.3	90.5	0.85	0.79	0.68
FLSES 132 M	9	59.1	2.8	3.4	7.8	0.02722	78	61	1454	17.5	89.7	90.7	90.6	0.83	0.77	0.65
FLSES 160 M	11	71.6	2.3	2.7	7.7	0.0601	114	55	1468	20.9	90.6	91.5	91.5	0.84	0.79	0.68
FLSES 160 L	15	98	2.5	3.4	7.7	0.0551	115	59	1462	28.3	91.1	92.1	92.2	0.84	0.79	0.68
FLSES 180 MT	18.5	121	2.7	3.3	8.0	0.0844	135	58	1464	34.7	91.4	92.2	92.2	0.84	0.79	0.67
FLSES 180 L	22	143	3.0	3.0	7.6	0.1333	170	70	1466	41	92.3	93.1	93.1	0.84	0.80	0.70
FLSES 200 LU	30	195	2.6	2.2	6.3	0.2035	250	66	1470	56.3	92.7	93.4	93.4	0.83	0.79	0.69
FLSES 225 SR	37	240	2.7	2.7	6.6	0.2467	275	66	1470	69.5	93.0	93.8	93.9	0.83	0.79	0.69
FLSES 225 M	45	290	2.1	2.7	6.7	0.6482	380	65	1484	83.9	93.5	93.9	93.8	0.83	0.79	0.70
FLSES 250 MR	55	354	2.1	2.5	6.9	0.7701	440	67	1482	102	94.0	94.4	94.3	0.83	0.79	0.70
FLSES 280 S	75	482	2.5	2.7	7.8	0.85	595	74	1484	137	94.0	94.2	93.9	0.84	0.80	0.71
FLSES 280 M	90	579	2.4	2.7	7.8	0.98	605	74	1483	164	94.2	94.4	94.1	0.84	0.82	0.72
FLSES 315 S	110	707	2.1	2.7	6.6	1.84	930	74	1486	200	94.5	94.7	94.3	0.84	0.81	0.72
FLSES 315 M	132	848	2.8	2.8	6.8	2.09	985	74	1487	237	94.7	94.9	94.5	0.85	0.82	0.76
FLSES 315 LA	160	1030	2.8	2.4	6.6	2.35	1045	74	1484	286	94.9	95.1	94.7	0.85	0.82	0.75
FLSES 315 LB	200	1285	2.7	2.9	7.2	2.86	1245	74	1486	357	95.1	95.3	94.9	0.85	0.83	0.76
FLSES 355 LA	250	1604	2.6	3.1	7.5	4.9	1445	80	1488	441	95.1	95.3	94.9	0.86	0.82	0.71
FLSES 355 LAL	280	1798	2.3	2.9	7.4	5.8	1560	80	1487	488	95.1	95.3	94.9	0.87	0.84	0.77
FLSES 355 LB	315	2020	2.5	3.8	7.8	6.56	1720	80	1488	550	95.1	95.3	94.9	0.87	0.81	0.71
FLSES 355 LC	355	2280	2.1	3.4	6.7	6.56	1720	80	1487	612	95.1	95.3	94.9	0.88	0.82	0.72
FLSES 355 LD	400	2577	1.9	2.3	5.8	6.6	1750	80	1488	708	95.9	95.3	94.9	0.85	0.80	0.77
FLS 400 LB	400	2559	2.0	2.6	8.0	11.7	2350	82	1491	694	95.6	95.8	95.3	0.87	0.85	0.78
FLS 355 LKB	450	2880	1.8	2.3	7.6	11.7	2320	82	1490	774	95.4	95.6	95.1	0.88	0.86	0.79
FLS 400 LB	450	2880	1.8	2.3	7.6	11.7	2350	87	1490	774	95.4	95.6	95.1	0.88	0.86	0.79
FLS 355 LKB	500	3200	1.7	2.2	6.5	11.7	2320	82	1490	862	95.1	95.3	94.8	0.88	0.86	0.79
FLS 400 LVB	500	3200	1.7	2.2	6.5	11.7	2350	87	1490	862	95.1	95.3	94.8	0.88	0.86	0.79
FLS 450 LA	500	3200	1.6	2.2	8.0	21	3100	82	1492	866	95.8	96.0	95.5	0.87	0.85	0.78
FLS 450 LVA	550	3525	1.5	2.1	7.9	21	3100	85	1491	942	95.8	96.0	95.5	0.88	0.86	0.79
FLS 450 LB	630	4030	1.5	2.1	8.2	24	3450	82	1493	1090	95.9	96.1	95.6	0.87	0.85	0.78
FLS 450 LVB	675	4326	1.4	1.9	8.0	24	3450	85	1491	1168	95.9	96.1	95.6	0.87	0.85	0.78
6 poles																
FLSES 90 SL	0.75	7.6	2.0	2.3	4.2	0.00338	23.1	44	945	2	78.20	78.90	76.50	0.70	0.61	0.48
FLSES 90 L	1.1	11.2	1.9	2.4	4.3	0.00437	26.1	42	940	2.9	79.10	80.50	79.20	0.71	0.62	0.49
FLSES 100 LK	1.5	14.9	1.8	2.3	4.5	0.01363	39.2	42	960	3.8	81.60	82.80	81.70	0.71	0.64	0.51
FLSES 112 MG	2.2	21.9	1.9	2.4	4.9	0.01523	42.5	43	960	5.4	81.80	82.90	81.70	0.72	0.64	0.50
FLSES 132 SM	3	29.7	2.1	2.5	5.4	0.02194	63.1	50	966	6.9	85.30	86.30	85.70	0.74	0.68	0.56
FLSES 132 M	4	39.7	2.2	2.5	5.5	0.02528	66.7	50	962	8.8	85.30	86.80	86.70	0.77	0.70	0.58
FLSES 132 M	5.5	54.4	2.6	2.8	5.8	0.03027	73	53	966	12.6	86.10	87.20	86.70	0.73	0.66	0.53
FLSES 160 M	7.5	73.4	1.9	3.0	5.7	0.0912	114	58	976	16.7	87.50	87.60	85.80	0.74	0.66	0.52
FLSES 160 LUR	11	108	1.9	2.8	6.1	0.1378	135	59	974	23.6	88.80	89.10	87.90	0.76	0.69	0.57
FLSES 180 L	15	147	2.6	3.0	6.9	0.2048	170	60	972	30.1	89.80	90.80	90.70	0.80	0.75	0.64
FLSES 200 LU	18.5	181	2.2	3.0	6.7	0.2588	210	61	978	37.7	90.70	91.30	90.60	0.78	0.72	0.60
FLSES 200 LU	22	216	2.1	2.4	6.1	0.2588	260	61	972	43.1	91.00	92.20				

IMfinity® 3-phase induction motors - High efficiency & Premium efficiency

IP55 Cast Iron frame

Electrical and mechanical characteristics

IE2 powered by the mains

Type	Rated power P_n kW	380 V 50 Hz				415 V 50 Hz				460 V 60 Hz			
		Rated speed N_n min ⁻¹	Rated current I_n A	Efficiency η 4/4	Power factor $\cos \phi$ 4/4	Rated speed N_n min ⁻¹	Rated current I_n A	Efficiency η 4/4	Power factor $\cos \phi$ 4/4	Rated speed N_n min ⁻¹	Rated current I_n A	Efficiency η 4/4	Power factor $\cos \phi$ 4/4
2 poles													
FLSES 80 L	0.75	2815	1.65	78.6	0.88	2860	1.55	80.2	0.84	3470	1.4	81.7	0.83
FLSES 80 L	1.1	2820	2.4	79.6	0.87	2860	2.25	81.3	0.83	3475	2.05	83.0	0.82
FLSES 90 SL	1.5	2830	3.15	81.5	0.89	2875	2.9	83.8	0.86	3485	2.6	85.4	0.85
FLSES 90 L	2.2	2825	4.65	83.2	0.88	2870	4.3	84.1	0.84	3485	3.85	86.1	0.84
FLSES 100 L	3	2830	6.15	84.6	0.88	2875	5.85	85.8	0.83	3485	5.15	86.8	0.84
FLSES 112 MU	4	2910	7.85	87.8	0.88	2930	7.5	88.5	0.84	3535	6.6	89.6	0.85
FLSES 132 SM	5.5	2910	10.8	88.7	0.87	2930	9.95	90.2	0.85	3540	8.9	90.7	0.85
FLSES 132 SM	7.5	2900	14.7	88.1	0.88	2925	13.7	89.7	0.85	3535	12.1	90.5	0.86
FLSES 132 M	9	2915	17.4	89.6	0.88	2940	16.3	90.8	0.85	3540	14.5	91.9	0.85
FLSES 160 M	11	2940	21.1	90.0	0.88	2954	19.9	91.2	0.85	3554	17.7	91.3	0.85
FLSES 160 M	15	2930	28.1	90.3	0.90	2950	25.6	92.3	0.88	3554	22.7	92.8	0.89
FLSES 160 L	18.5	2935	34.7	90.9	0.90	2945	31.6	92.5	0.88	3550	28.1	93.0	0.89
FLSES 180 MR	22	2925	41	91.3	0.89	2945	37.7	92.3	0.88	3554	33.8	93.0	0.88
FLSES 200 LU	30	2945	56.2	92.0	0.88	2954	51.8	93.9	0.86	3554	46.2	94.0	0.87
FLSES 200 LU	37	2935	68.5	92.5	0.89	2950	62.9	94.2	0.87	3552	56.1	94.1	0.88
FLSES 225 MR	45	2940	83.4	93.0	0.88	2956	75.8	94.6	0.87	3558	67.9	94.6	0.88
FLSES 250 M	55	2966	99.7	93.7	0.89	2972	87.5	94.4	0.87	3574	83.2	94.3	0.88
FLSES 280 S	75	2962	133	93.8	0.91	2958	123	93.9	0.90	3566	111	93.6	0.91
FLSES 280 M	90	2961	160	94.1	0.91	2971	148	94.2	0.90	3567	131	94.5	0.91
FLSES 315 S	110	3574	197	94.3	0.90	2978	182	94.4	0.89	3576	164	94.5	0.89
FLSES 315 M	132	2974	236	94.6	0.90	2978	218	94.6	0.89	3576	196	95.0	0.89
FLSES 315 LA	160	2973	285	94.8	0.90	2977	264	94.9	0.89	3575	237	95.2	0.89
FLSES 315 LB	200	2973	355	95.0	0.90	2977	329	95.1	0.89	3575	296	95.4	0.89
FLSES 355 LA	250	2976	449	95.0	0.89	2982	416	95.1	0.88	3578	374	95.4	0.88
FLSES 355 LB	315	2981	566	95.0	0.89	2985	524	95.1	0.88	3583	471	95.4	0.88
FLSES 355 LC	355	2979	645	95.0	0.88	2983	597	95.1	0.87	3581	537	95.4	0.87
FLSES 355 LD	400	2987	710	95.0	0.90	2991	657	95.1	0.89	3589	591	95.4	0.89
4 poles													
FLSES 80 LG	0.75	1435	1.75	80.3	0.82	1450	1.7	81.0	0.76	1756	1.5	83.5	0.75
FLSES 90 SL	1.1	1430	2.45	81.4	0.84	1445	2.35	82.2	0.79	1752	2.1	84.6	0.78
FLSES 90 L	1.5	1430	3.25	82.8	0.85	1445	3.1	83.4	0.80	1750	2.8	85.6	0.79
FLSES 100 L	2.2	1435	4.65	84.3	0.85	1450	4.45	85.4	0.80	1752	4	87.1	0.80
FLSES 100 LG	3	1440	6.2	85.5	0.86	1456	5.95	86.7	0.81	1756	5.4	87.5	0.80
FLSES 112 MU	4	1440	8.2	86.6	0.86	1454	7.65	88.1	0.83	1758	7.05	89.4	0.80
FLSES 132 SM	5.5	1450	11	87.9	0.86	1460	10.6	88.9	0.81	1764	9.45	90.3	0.81
FLSES 132 M	7.5	1445	14.8	88.7	0.87	1458	14.2	89.5	0.82	1762	12.5	90.9	0.83
FLSES 132 M	9	1450	17.8	89.0	0.86	1458	17.3	89.9	0.81	1764	15.2	91.3	0.82
FLSES 160 M	11	1464	21.4	90.5	0.86	1472	20.5	91.3	0.82	1772	18	92.2	0.83
FLSES 160 L	15	1458	29.1	90.6	0.87	1468	27.9	91.2	0.82	1770	24.5	92.4	0.83
FLSES 180 MT	18.5	1460	36	91.2	0.85	1468	34.5	91.3	0.82	1770	30.2	92.7	0.83
FLSES 180 L	22	1462	42.4	91.8	0.86	1470	40	92.5	0.83	1772	35.6	93.4	0.83
FLSES 200 LU	30	1456	58.2	92.3	0.85	1474	52.3	93.1	0.81	1780	48.8	93.8	0.82
FLSES 225 SR	37	1466	71.6	92.4	0.85	1474	64.1	93.4	0.81	1776	60.1	94.2	0.82
FLSES 225 M	45	1482	85.2	93.1	0.85	1486	80.5	94.9	0.82	1788	71.4	95.1	0.83
FLSES 250 MR	55	1480	107	93.5	0.84	1484	99.3	94.2	0.82	1784	88.3	95.3	0.82
FLSES 280 S	75	1482	143	94.0	0.85	1486	134	94.1	0.83	1784	119	94.5	0.84
FLSES 280 M	90	1481	169	94.2	0.86	1485	158	94.3	0.84	1785	141	94.5	0.85
FLSES 315 S	110	1483	208	94.5	0.85	1487	193	95.5	0.83	1786	173	95.0	0.84
FLSES 315 M	132	1484	246	94.7	0.86	1487	231	94.8	0.84	1787	205	95.0	0.85
FLSES 315 LA	160	1482	298	94.9	0.86	1486	279	95.0	0.84	1784	248	95.2	0.85
FLSES 315 LB	200	1483	372	95.1	0.86	1487	348	95.2	0.84	1784	310	95.4	0.85
FLSES 355 LA	250	1487	459	95.1	0.87	1490	430	95.2	0.85	1788	382	95.4	0.86
FLSES 355 LAL	280	1486	508	95.1	0.88	1489	476	95.2	0.86	1787	423	95.4	0.87
FLSES 355 LB	315	1485	572	95.1	0.88	1488	535	95.2	0.86	1787	476	95.4	0.87
FLSES 355 LC	355	1484	637	95.1	0.89	1488	596	95.2	0.87	1787	531	95.4	0.88
FLSES 355 LD	400	1486	743	95.1	0.86	1487	696	95.2	0.84	1788	619	95.4	0.85
FLS 400 LB	400	1489	724	95.4	0.88	1493	683	95.8	0.85	1791	605	95.4	0.87
FLS 355 LKB	450	1488	807	95.2	0.89	1492	761	95.6	0.86	1790	673	95.4	0.88
FLS 400 LB	450	1488	807	95.2	0.89	1492	761	95.6	0.86	1790	673	95.4	0.88
FLS 355 LKB	500	1488	898	95.1	0.89	1492	849	95.3	0.86	1790	748	95.4	0.88
FLS 400 LVB	500	1488	898	95.1	0.89	1492	849	95.3	0.86	1790	748	95.4	0.88
FLS 450 LA	500	1490	903	95.6	0.88	1493	853	95.9	0.85	1792	756	95.4	0.87
FLS 450 LVA	550	1489	982	95.6	0.89	1493	928	95.9	0.86	1791	822	95.4	0.88
FLS 450 LB	630	1491	1137	95.7	0.88	1494	1075	95.9	0.85	1793	953	95.4	0.87
FLS 450 LVB	675	1489	1218	95.7	0.88	1493	1152	95.9	0.85	1791	1021	95.4	0.87
6 poles													
FLSES 90 SL	0.75	940	2	77.1	0.74	954	1.95	78.1	0.68	-	-	-	-
FLSES 90 L	1.1	930	2.9	78.1	0.74	950	2.85	79.3	0.68	-	-	-	-
FLSES 100 LK	1.5	954	3.8	80.4	0.74	966	3.65	81.9	0.70	-	-	-	-
FLSES 112 MG	2.2	954	5.5	81.8	0.75	964	5.4	82.0	0.69	-	-	-	-
FLSES 132 SM	3	960	7.05	84.2	0.77	968	6.75	85.6	0.72	-	-	-	-
FLSES 132 M	4	954	9.15	84.6	0.79	966	8.8	85.9	0.74	-	-	-	-
FLSES 132 M	5.5	960	13	86.0	0.75	970	13	86.4	0.68	-	-	-	-
FLSES 160 M	7.5	970	16.7	87.3	0.78	978	16.9	87.4	0.71	-	-	-	-
FLSES 160 LUR	11	972	24	88.7	0.79	978	23.4	88.8	0.74	-	-	-	-
FLSES 180 L	15	968	31	89.7	0.82	976	29.6	90.2	0.78	-	-	-	-
FLSES 200 LU	18.5	974	38.5	90.4	0.81	980	37.6	90.8	0.75	-	-	-	-
FLSES 200 LU	22	966	44.8	90.8	0.82	976	42.2	91.3	0.80	-	-	-	-
FLSES 225 M	30	984	58	91.7	0.86	986	54.5	92.3	0.83	-	-	-	-
FLSES 250 M	37	984	70.5	92.3	0.87	986	66.9	92.8	0.83	-	-	-	-
FLSES 280 S	45	984	85	92.7	0.87	987	81	92.8	0.83	1186	71	93.6	0.85
FLSES 280 M	55	984	104	93.1	0.86	988	99	93.2	0.83	1186	87	93.6	0.85
FLSES 315 S	75	989	147	93.7	0.83	992	141	93.8	0.79	1191	124	94.1	0.81
FLSES 315 M	90	987	177	94.0	0.82	990	171	94.1	0.78	1189	150	94.1	0.80
FLSES 315 LA	110	987	214	94.3	0.83	991	203	94.4	0.80	1189	177	95.0	0.82
FLSES 315 LB	132	988	147	94.6	0.86	991	249	94.7	0.78	1190	218	95.0	0.80
FLSES 355 LA	160	991	302	94.8	0.85	994	283	94.9	0.83	1193	249	95.0	0.85
FLSES 355 LB	200	991	390	95.0	0.82	994	357	95.1	0.82	1193	315	95.0	0.84
FLSES 355 LC	250	991	488	95.0	0.82	994	463	95.1	0.79	1193	408	95.0	0.81
FLSES 355 LKA	315	991	607	95.0	0.83	994	576	95.1	0.80	1193	508	95.0	0.82
FLSES 355 LKB	355	990	676	95.0	0.84	993	641	95.1	0.81	1192	565	95.0	0.83
FLS 400 LA	400	994	799	95.1	0.80	997	768	95.3	0.76	1190	675	95.4	0.78
FLS 400 LKB	500	994	985	95.2	0.81	997	946	95.5	0.77	1190	833	95.4	0.79
FLS 450 LB	500	994	985	95.2	0.81	997	946</						

IMfinity® 3-phase induction motors - High efficiency & Premium efficiency

IP55 Cast Iron frame

Electrical and mechanical characteristics

IE2 powered by the drive

Type	400 V 50 Hz				% Rated torque M _n at					400 V 87 Hz Δ ¹				Maximum mechanical speed ²
	Rated power	Rated speed	Rated current	Power factor	10 Hz	17 Hz	25 Hz	50 Hz	87 Hz	Rated power	Rated speed	Rated current	Power factor	
	P _n kW	N _n min ⁻¹	I _n A	cos φ 4/4						P _n kW	N _n min ⁻¹	I _n A	cos φ 4/4	
2 poles														
FLSES 80 L	0.75	2775	1.8	0.86	90%	100%	100%	100%	57%	1.31	4995	3.13	0.86	13500
FLSES 80 L	1.1	2775	2.6	0.85	85%	100%	100%	100%	57%	1.91	4995	4.56	0.85	13500
FLSES 90 SL	1.5	2790	3.45	0.87	85%	100%	100%	100%	57%	2.61	5010	5.99	0.87	11700
FLSES 90 L	2.2	2775	5.1	0.86	85%	100%	100%	100%	57%	3.83	4995	8.85	0.86	11700
FLSES 100 L	3	2790	6.6	0.87	85%	100%	100%	100%	57%	5.22	5010	11.44	0.87	9900
FLSES 112 MU	4	2895	8.4	0.86	85%	100%	100%	100%	57%	6.96	5115	14.65	0.86	9900
FLSES 132 SM	5.5	2890	11.8	0.86	85%	100%	100%	100%	57%	9.57	5110	20.55	0.86	6700
FLSES 132 SM	7.5	2875	16.2	0.87	85%	95%	100%	100%	57%	13.05	5095	28.24	0.87	6700
FLSES 132 M	9	2900	19	0.86	85%	95%	100%	100%	57%	15.66	5120	33.06	0.86	6700
FLSES 160 M	11	2935	22.5	0.86	85%	95%	100%	100%	57%	19.14	5155	39.14	0.86	6030
FLSES 160 M	15	2925	30.1	0.89	85%	95%	100%	100%	57%	26.1	5145	52.36	0.89	6030
FLSES 160 L	18.5	2905	37.4	0.89	85%	95%	100%	100%	57%	32.19	5125	65.05	0.89	5670
FLSES 180 M	22	2905	42.7	0.88	81%	90%	95%	100%	54%	36.27	5125	74.34	0.88	5670
FLSES 200 LU	30	2935	59.7	0.87	85%	90%	100%	100%	-	-	-	-	-	4500
FLSES 200 LU	37	2920	74	0.88	80%	90%	100%	100%	-	-	-	-	-	4500
FLSES 225 MR	45	2930	88.6	0.86	80%	90%	100%	100%	-	-	-	-	-	4320
FLSES 250 M	55	2960	108	0.88	80%	90%	100%	100%	-	-	-	-	-	4050
FLSES 280 S	75	2964	135	0.91	79%	89%	100%	100%	-	-	-	-	-	3580
FLSES 280 M	90	2965	164	0.91	79%	89%	100%	100%	-	-	-	-	-	3580
FLSES 315 S	110	2976	202	0.90	79%	89%	100%	100%	-	-	-	-	-	3580
FLSES 315 M	132	2976	243	0.90	79%	89%	100%	100%	-	-	-	-	-	3580
FLSES 315 LA	160	2975	193	0.90	79%	89%	100%	100%	-	-	-	-	-	3580
FLSES 315 LB	200	2975	365	0.90	79%	89%	100%	100%	-	-	-	-	-	3580
FLSES 355 LA	250	2978	461	0.89	98%	100%	100%	100%	-	-	-	-	-	3580
FLSES 355 LB	315	2983	538	0.89	79%	89%	100%	100%	-	-	-	-	-	3580
FLSES 355 LC	355	2981	663	0.88	79%	89%	100%	100%	-	-	-	-	-	3580
4 poles														
FLSES 80 LG	0.75	1425	1.9	0.79	90%	100%	100%	100%	57%	1.31	2535	3.31	0.79	11700
FLSES 90 SL	1.1	1420	2.6	0.81	90%	100%	100%	100%	57%	1.91	2530	4.56	0.81	11700
FLSES 90 L	1.5	1415	3.5	0.82	90%	100%	100%	100%	57%	2.61	2525	6.17	0.82	9900
FLSES 100 L	2.2	1420	5.1	0.82	90%	100%	100%	100%	57%	3.83	2530	8.85	0.82	9900
FLSES 100 LG	3	1435	6.6	0.83	90%	100%	100%	100%	57%	5.22	2545	11.53	0.83	9900
FLSES 112 MU	4	1425	9	0.84	90%	100%	100%	100%	57%	6.96	2535	15.64	0.84	9900
FLSES 132 SM	5.5	1440	12	0.83	90%	90%	100%	100%	57%	9.57	2550	20.91	0.83	6700
FLSES 132 M	7.5	1435	16	0.85	90%	90%	100%	100%	57%	13.05	2545	27.88	0.85	6700
FLSES 132 M	9	1440	19.3	0.83	90%	90%	100%	100%	57%	15.66	2550	33.6	0.83	6700
FLSES 160 M	11	1456	23.1	0.84	85%	95%	100%	100%	57%	19.14	2566	40.21	0.84	6030
FLSES 160 L	15	1450	31.3	0.85	85%	95%	100%	100%	57%	26.1	2560	54.5	0.85	6030
FLSES 180 MT	18.5	1450	38.1	0.84	79%	89%	99%	100%	57%	31.73	2560	66.23	0.84	6030
FLSES 180 L	22	1452	46.2	0.84	80%	90%	100%	100%	57%	38.28	2562	80.42	0.84	6030
FLSES 200 LU	30	1458	63	0.83	85%	95%	100%	100%	57%	52.2	2568	109.54	0.83	4500
FLSES 225 SR	37	1458	77.5	0.83	85%	95%	100%	100%	57%	64.38	2568	134.92	0.83	4320
FLSES 225 M	45	1478	92.9	0.84	85%	95%	100%	100%	57%	78.3	2588	161.73	0.84	4050
FLSES 250 MR	55	1476	114	0.83	85%	95%	100%	100%	57%	95.7	2586	198.36	0.83	4050
FLSES 280 S	75	1485	148	0.84	79%	89%	100%	100%	56%	75	2610	148	0.84	2610
FLSES 280 M	90	1485	177	0.84	79%	89%	100%	100%	57%	90	2610	177	0.84	2610
FLSES 315 S	110	1486	210	0.86	90%	100%	100%	100%	57%	110	2610	210	0.86	2610
FLSES 315 M	132	1487	250	0.87	96%	100%	100%	100%	57%	132	2610	250	0.87	2610
FLSES 315 LA	160	1484	303	0.87	95%	99%	100%	100%	57%	160	2610	303	0.87	2610
FLSES 315 LB	200	1486	374	0.87	94%	98%	100%	100%	55%	200	2610	374	0.87	2610
FLSES 355 LA	250	1488	465	0.87	98%	100%	100%	100%	57%	250	2610	465	0.87	2610
FLSES 355 LAL	280	1487	507	0.87	96%	99%	100%	100%	58%	280	2610	507	0.87	2610
FLSES 355 LB	315	1488	594	0.87	79%	89%	100%	100%	57%	315	2610	594	0.87	2610
FLSES 355 LK	355	1487	670	0.87	78%	89%	100%	100%	57%	355	2610	670	0.87	2610
6 poles														
FLSES 90 SL	0.75	925	2.1	0.70	100%	100%	100%	100%	57%	1.31	1665	3.66	0.70	11700
FLSES 90 L	1.1	915	3.1	0.71	100%	100%	100%	100%	57%	1.91	1655	5.36	0.71	11700
FLSES 100 LG	1.5	945	4.15	0.71	100%	100%	100%	100%	57%	2.61	1685	7.24	0.71	9900
FLSES 112 M	2.2	940	5.9	0.72	100%	100%	100%	100%	57%	3.83	1680	10.28	0.72	9900
FLSES 132 SM	3	952	7.5	0.74	100%	100%	100%	100%	57%	5.22	1692	13.13	0.74	6700
FLSES 132 M	4	945	9.8	0.77	100%	100%	100%	100%	57%	6.96	1685	17.07	0.77	6700
FLSES 132 M	5.5	952	13.8	0.73	100%	100%	100%	100%	57%	9.57	1692	23.95	0.73	6700
FLSES 160 M	7.5	966	17.8	0.74	100%	100%	100%	100%	57%	13.05	1706	30.92	0.84	6030
FLSES 160 LUR	11	966	25.5	0.76	95%	100%	100%	100%	57%	19.14	1706	44.32	0.84	6030
FLSES 180 L	15	964	33.5	0.80	80%	90%	100%	100%	57%	26.1	1704	58.26	0.84	6030
FLSES 200 LU	18.5	968	40.9	0.78	80%	90%	100%	100%	57%	32.19	1708	71.12	0.84	4500
FLSES 200 LU	22	958	49.1	0.81	80%	90%	100%	100%	57%	38.28	1698	85.42	0.84	4500
FLSES 225 MG	30	980	61.7	0.84	90%	100%	100%	100%	57%	52.20	1720	107.4	0.84	4050
FLSES 250 M	37	982	75.4	0.85	90%	100%	100%	100%	57%	64.38	1722	131.17	0.85	4050
FLSES 280 S	45	986	89	0.9	79%	89%	100%	100%	57%	45	1740	89	0.85	1740
FLSES 280 M	55	986	108	0.9	79%	89%	100%	100%	57%	55	1740	108	0.85	1740
FLSES 315 S	75	990	155	0.8	79%	89%	100%	100%	54%	75	1740	155	0.80	1740
FLSES 315 M	90	991	187	0.8	79%	89%	100%	100%	57%	90	1740	187	0.80	1740
FLSES 315 LA	110	991	228	0.8	79%	89%	100%	100%	57%	110	1740	228	0.80	1740
FLSES 315 LB	132	990	272	0.8	79%	89%	100%	100%	57%	132	1740	272	0.80	1740
FLSES 355 LA	160	993	310	0.85	79%	89%	100%	100%	57%	160	1740	310	0.85	1740
FLSES 355 LB	200	993	391	0.84	79%	89%	100%	100%	57%	200	1740	391	0.84	1740
FLSES 355 LC	250	993	507	0.81	79%	89%	100%	100%	57%	250	1740	507	0.81	1740
FLSES 355 LKA	315	993	631	0.82	79%	89%	100%	100%	57%	315	1740	631	0.82	1740
FLSES 355 LKB	355	992	703	0.83	79%	89%	100%	100%	57%	355	1740	703	0.83	1740

(1) Data only valid for: 400 V 50 Hz Y motors and frame size ≤ 250 mm - 2 poles

(2) See Vibrations section on page 48



IP55 CAST IRON MOTORS

IMfinity® 3-phase induction motors - High efficiency & Premium efficiency

IP55 Cast Iron frame

Electrical and mechanical characteristics

IE2 powered by the drive

Summary of recommended protection devices

Mains voltage	Cable length	Frame size	Winding protection	Insulated bearings
≤ 480 V	< 20 m	All frame sizes	Standard	No
	> 20 m and < 100 m	< 315	Standard	No
		≥ 315	RIS or drive filter	NDE
> 480 V and ≤ 690 V	< 20 m	< 250	Standard	No
		≥ 250	RIS or drive filter	NDE
	> 20 m and < 100 m	< 250	RIS or drive filter	NDE
		≥ 250	RIS or drive filter	NDE
		≥ 250	RIS or drive filter	NDE (or DE+NDE if no filter for ≥ 315)

RIS: Reinforced Insulation System.

The filter is recommended above frame size 315.

Standard insulation = 1500 V peak and 3500 V/μs.

Service solutions exist (insulation for winding and bearings).

For different cable length(s) and/or voltage(s), please consult Leroy-Somer.

Motors of frame size ≥ 280 with RIS option are no longer cURus.



REMINDER: All 2, 4 and 6 pole motors placed on the EU market must be IE3 or IE2 and used with a variable speed drive:

- from 01/01/2015 for power ratings from 7.5 to 375 kW
- from 01/01/2017 for power ratings from 0.75 to 375 kW

Other drive mechanism solutions:



LSRPM: permanent magnet synchronous motors 0.75 to 375 kW

Variable speed application, requiring IP55 protection, high efficiency and/or compact dimensions.



CPLS: induction motors 95 to 1600 Nm

Application for variable speed operation requiring constant power over a wide speed range.



LSMV: induction motors 0.25 to 132 kW

Application for variable speed operation requiring constant torque over a wide speed range.



LSK: D.C. motors 2 to 750 kW



UNIMOTOR FM and HD: servomotors 0.7 to 410 Nm

IP55 CAST IRON MOTORS

IMfinity® 3-phase induction motors - High efficiency & Premium efficiency

IP55 Cast Iron frame

Electrical and mechanical characteristics

IE3 powered by the mains

Type	Rated power P _n kW	Rated torque M _n N.m	Starting torque/ Rated torque M _d /M _n	Maximum torque/ Rated torque M _m /M _n	Starting current/ Rated current I _d /I _n	Moment of inertia J kg.m ²	Weight IM B3 kg	Noise LP db(A)	400V 50 Hz							
									Rated speed N _n min ⁻¹	Rated current I _n A	Efficiency IEC 60034-2-1 2007 η			Power factor Cos φ		
											4/4	3/4	2/4	4/4	3/4	2/4
2 poles																
FLSES 80 L	0.75	2.5	2.8	3.6	7.0	0.00095	16.2	59	2885	1.6	81.7	81.8	79.6	0.83	0.76	0.62
FLSES 80 LG	1.1	3.65	2.4	3.2	6.6	0.00201	22.5	59	2885	2.25	83.7	84.5	83.7	0.85	0.79	0.68
FLSES 90 SL	1.5	4.95	2.9	3.0	7.0	0.00223	24	68	2890	3	85.0	86.0	85.3	0.85	0.79	0.68
FLSES 90 LU	2.2	7.25	3.4	3.2	8.1	0.00292	28.2	70	2895	4.3	86.3	87.5	87.4	0.86	0.80	0.70
FLSES 100 L	3	9.9	3.2	3.6	8.1	0.00364	35.2	66	2895	5.75	87.3	88.3	88.0	0.86	0.81	0.70
FLSES 112 MG	4	13.1	2.1	3.0	7.2	0.00941	44.8	66	2920	7.5	88.5	89.2	88.6	0.87	0.82	0.72
FLSES 132 SM	5.5	17.9	2.0	2.8	6.5	0.00974	69.3	67	2935	10.2	89.6	90.4	90.0	0.87	0.83	0.74
FLSES 132 SM	7.5	24.4	2.1	2.9	6.9	0.01102	74.6	67	2940	13.9	90.7	91.5	91.3	0.86	0.82	0.73
FLSES 132 M	9	29.2	2.5	3.2	7.6	0.01203	78.2	67	2940	16.8	91.3	92.0	91.7	0.85	0.80	0.72
FLSES 160 M	11	35.5	3.4	3.1	8.5	0.0712	120	68	2956	19.3	92.2	92.6	92.1	0.89	0.86	0.79
FLSES 160 M	15	48.6	2.9	2.9	7.3	0.0551	133	68	2950	26.7	92.4	93.1	93.1	0.88	0.85	0.79
FLSES 160 LUR	18.5	59.9	2.9	2.8	7.4	0.0626	135	69	2950	32.9	92.5	93.2	93.2	0.88	0.86	0.79
FLSES 180 MUR	22	71.2	3.0	3.4	8.1	0.1012	195	74	2952	38	93.6	94.1	93.8	0.89	0.87	0.81
FLSES 200 LU	30	97.1	2.1	3.1	7.3	0.1186	210	71	2950	53.1	93.9	94.3	94.0	0.87	0.84	0.77
FLSES 200 LU	37	120	2.1	3.4	7.0	0.1388	230	75	2945	64.5	94.0	94.6	94.5	0.88	0.86	0.80
FLSES 225 MR	45	146	2.3	3.1	7.5	0.1597	254	71	2950	78.2	94.2	94.8	94.8	0.88	0.86	0.80
FLSES 250 M	55	177	2.1	3.2	7.7	0.3356	378	78	2968	95.3	94.5	94.6	93.7	0.88	0.85	0.79
FLSES 280 S	75	241	2.1	2.7	7.0	0.48	565	79	2966	126	94.9	95.3	95.2	0.91	0.89	0.85
FLSES 280 M	90	290	2.2	2.8	7.4	0.57	615	80	2967	151	95.3	95.7	95.5	0.90	0.89	0.85
FLSES 315 S	110	353	2.1	2.6	6.7	1.17	940	82	2975	185	95.7	95.9	94.6	0.90	0.89	0.84
FLSES 315 M	132	424	2.1	2.5	6.7	1.25	1015	82	2975	221	96.0	96.1	95.6	0.90	0.89	0.84
FLSES 315 LA	160	514	2.0	2.9	7.7	1.34	1088	82	2975	270	96.0	96.1	95.6	0.89	0.87	0.83
FLSES 315 LB	200	643	2.1	2.5	6.9	1.45	1150	82	2973	334	96.3	96.5	96.0	0.90	0.88	0.84
FLSES 355 LA	250	802	2.9	2.9	6.8	3.02	1590	83	2978	428	96.0	96.0	95.3	0.88	0.86	0.80
FLSES 355 LB	315	1008	2.8	3.6	7.7	3.62	1740	84	2983	537	96.2	96.2	95.6	0.88	0.86	0.81
FLSES 355 LC	355	1137	2.5	3.2	7.3	3.64	1740	84	2981	612	96.3	96.0	95.1	0.87	0.84	0.78
FLSES 355 LD	400	1282	2.0	2.9	7.2	3.7	1770	84	2989	670	97.0	97.1	96.9	0.89	0.88	0.85
4 poles																
FLSES 80 LG	0.75	4.95	2.2	3.1	6.6	0.00335	22	57	1450	1.65	83.2	84.0	82.9	0.80	0.72	0.59
FLSES 90 SL	1.1	7.25	2.4	3.2	7.5	0.00418	24.6	48	1450	2.3	84.8	85.7	84.9	0.81	0.74	0.61
FLSES 90 LU	1.5	9.85	2.8	3.6	7.5	0.00524	28.2	51	1454	3.2	85.6	86.0	84.5	0.79	0.71	0.57
FLSES 100 LR	2.2	14.5	3.5	3.9	8.3	0.00676	36.4	49	1452	4.6	86.9	87.4	86.3	0.79	0.71	0.57
FLSES 100 LG	3	19.6	2.5	3.3	7.2	0.01152	42.2	50	1460	6.05	88.3	89.1	88.6	0.81	0.74	0.61
FLSES 112 MU	4	26.2	2.7	3.1	7.1	0.01429	48.9	50	1458	8.1	88.8	89.6	89.2	0.80	0.73	0.62
FLSES 132 SM	5.5	35.9	2.9	3.7	8.4	0.02286	70.9	60	1462	10.5	90.1	90.7	90.2	0.84	0.78	0.67
FLSES 132 MR	7.5	49.1	2.8	3.4	8.5	0.03313	89.4	61	1460	13.8	90.6	91.5	91.3	0.86	0.81	0.71
FLSES 160 M	9	58.5	2.4	3.1	8.3	0.0601	105	59	1468	16.7	91.3	92.0	91.7	0.85	0.80	0.70
FLSES 160 M	11	71.7	2.3	2.9	7.6	0.0712	115	59	1466	20.1	91.7	92.7	92.8	0.86	0.82	0.73
FLSES 160 LUR	15	97.4	2.3	3.2	8.0	0.0954	140	58	1470	27.5	92.3	93.0	92.9	0.85	0.81	0.72
FLSES 180 M	18.5	120	3.1	3.4	8.1	0.1333	165	67	1470	34.1	92.8	93.5	93.4	0.84	0.80	0.71
FLSES 180 LUR	22	143	3.3	3.3	7.9	0.1555	190	68	1470	41.2	93.2	93.8	93.6	0.83	0.79	0.69
FLSES 200 LU	30	194	3.1	2.9	7.3	0.2035	250	64	1474	54.9	93.9	94.4	94.2	0.84	0.80	0.70
FLSES 225 S	37	238	2.0	2.7	6.8	0.5753	355	65	1484	67.5	94.0	94.4	94.1	0.84	0.80	0.71
FLSES 225 M	45	290	2.1	2.7	6.8	0.6482	380	64	1484	82.9	94.7	95.1	95.0	0.83	0.79	0.70
FLSES 250 MR	55	354	2.1	2.5	6.9	0.7701	440	67	1482	101	94.8	95.2	95.1	0.83	0.79	0.70
FLSES 280 S	75	482	2.5	2.7	7.8	0.85	595	74	1484	137	95.0	95.1	94.4	0.84	0.80	0.71
FLSES 280 M	90	579	2.4	2.7	7.8	0.98	645	74	1483	162	95.2	95.4	95.0	0.84	0.82	0.72
FLSES 315 S	110	707	2.7	2.4	6.6	1.84	930	74	1486	199	95.4	95.4	94.9	0.84	0.81	0.72
FLSES 315 M	132	848	2.8	2.8	6.8	2.09	985	74	1487	234	95.9	95.9	95.6	0.85	0.82	0.76
FLSES 315 LA	160	1030	2.8	2.4	6.6	2.35	1045	74	1484	283	96.0	96.2	96.0	0.85	0.82	0.75
FLSES 315 LB	200	1285	2.7	2.9	7.2	2.86	1245	74	1486	354	96.0	96.2	96.0	0.85	0.82	0.73
FLSES 355 LA	250	1604	2.6	3.1	7.5	4.9	1445	80	1488	436	96.3	96.3	94.7	0.86	0.82	0.71
FLSES 355 LAL	280	1798	2.3	2.9	7.4	5.8	1560	80	1487	483	96.2	96.4	95.9	0.87	0.84	0.77
FLSES 355 LB	315	2020	2.5	3.8	7.8	6.56	1720	80	1488	543	96.3	96.5	96.0	0.87	0.83	0.75
FLSES 355 LC	355	2280	2.1	3.4	6.7	6.56	1720	80	1487	607	96.0	96.2	95.7	0.88	0.84	0.76
FLSES 355 LD	400	2577	1.9	2.3	5.8	6.6	1750	80	1488	707	96.4	96.7	96.6	0.85	0.82	0.75
6 poles																
FLSES 90 SL	0.75	7.55	1.9	2.3	4.5	0.00378	24.2	40	950	1.9	79.1	80.1	78.3	0.72	0.63	0.50
FLSES 90 LU	1.1	11	2.3	2.6	4.8	0.00519	29.3	57	954	2.75	81.7	82.3	80.4	0.71	0.62	0.48
FLSES 100 LG	1.5	14.8	2.4	2.8	5.7	0.01523	41.3	47	966	3.6	83.5	84.1	82.6	0.72	0.64	0.50
FLSES 112 MU	2.2	21.7	2.3	2.8	5.6	0.01899	49	45	968	5.35	84.5	85.1	83.6	0.70	0.62	0.49
FLSES 132 SM	3	29.5	2.7	3.1	6.4	0.02528	65	50	972	6.85	86.5	86.9	85.6	0.73	0.66	0.53
FLSES 132 M	4	39.4	2.4	2.9	6.3	0.03027	72.7	54	970	9.15	87.3	87.9	86.7	0.72	0.65	0.53
FLSES 132 MU	5.5	54.4	2.7	2.8	6.3	0.03699	87	55	966	11.9	88.2	89.3	89.0	0.76	0.70	0.58
FLSES 160 MU	7.5	73.2	2.0	3.1	6.5	0.1295	117	57	978	17.4	89.5	89.6	88.3	0.77	0.70	0.57
FLSES 180 L	11	107	3.0	3.8	8.2	0.2048	170	61	982	22.6	91.0	91.2	90.3	0.77	0.70	0.58
FLSES 180 LUR	15	146	3.3	2.8	7.5	0.253	202	60	978	31.9	91.3	91.6	90.9	0.74	0.68	0.56
FLSES 200 LU	18.5	181	2.5	3.0	7.0	0.2588	210	60	978	36.6	91.9	92.6	92.4	0.79	0.74	0.64
FLSES 200 LU	22	214	2.8	3.6	7.4	0.2588	245	62	980	44.6	92.5	93.0	92.5	0.77	0.71	0.61
FLSES 225 M	30	291	2.2	2.5	6.6	0.8802	342	65	986	55.3	93.2	93.7	93.4	0.84	0.80	0.71
FLSES 250 M	37	358	2.5	2.7	7.0	0.9142	397	64	986	68.1	93.5	94.0	93.7	0.84	0.80	0.70
FLSES 280 S	45	436	2.8	3.0	7.4	1.08	555	70	986	81	94.1	94.4	94.0	0.85	0.81	0.71
FLSES 280 M	55	533	2.9	2.5	7.3	1.28	605	70	986	100	94.4	94.6	94.2	0.84	0.79	0.69
FLSES 315 S	75	723	3.1	2.7	7.9	2.5	965	72	991	141	95.0	95.1	94.5	0.81	0.77	0.67
FLSES 315 M	90	867	2.8	3.0	6.8	2.96	1035	72	989	166	95.3	95.6	95.3	0.82	0.79	0.71
FLSES 315 LA	110	1060	2.9	3.1	6.9	3.44	1150	72	989	203	95.2	95.5	95.5	0.82	0.79	0.71
FLSES 315 LB	132	1273	3.0	3.2	7.0											

IMfinity® 3-phase induction motors - High efficiency & Premium efficiency

IP55 Cast Iron frame

Electrical and mechanical characteristics

IE3 powered by the mains

Type	Rated power P _n kW	380V 50 Hz				415V 50 Hz				460V 60Hz			
		Rated speed	Rated current	Efficiency	Power factor	Rated speed	Rated current	Efficiency	Power factor	Rated speed	Rated current	Efficiency	Power factor
		N _n min ⁻¹	I _n A	η 4/4	Cos φ 4/4	N _n min ⁻¹	I _n A	η 4/4	Cos φ 4/4	N _n min ⁻¹	I _n A	η 4/4	Cos φ 4/4
2 poles													
FLSES 80 L	0.75	2870	1.65	81.4	0.85	2895	1.6	82.1	0.80	3505	1.4	82.7	0.80
FLSES 80 LG	1.1	2865	2.35	82.7	0.87	2890	2.2	84.1	0.83	3500	1.95	84.8	0.83
FLSES 90 SL	1.5	2870	3.1	84.2	0.87	2900	2.95	85.2	0.83	3505	2.65	86.0	0.83
FLSES 90 LU	2.2	2875	4.45	85.9	0.88	2905	4.15	86.9	0.84	3510	3.7	87.6	0.85
FLSES 100 L	3	2870	5.95	87.1	0.88	2900	5.6	87.5	0.85	3515	5.05	88.3	0.85
FLSES 112 MG	4	2910	7.75	88.1	0.89	2935	7.35	88.9	0.85	3540	6.6	89.2	0.86
FLSES 132 SM	5.5	2925	10.6	89.2	0.88	2940	9.85	90.1	0.86	3545	8.9	90.8	0.86
FLSES 132 SM	7.5	2930	14.6	90.1	0.87	2945	13.6	91.0	0.85	3550	12.3	90.6	0.85
FLSES 132 M	9	2935	17.3	91.1	0.87	2950	16.5	91.4	0.83	3554	14.6	92.3	0.84
FLSES 160 M	11	2950	20.2	91.8	0.90	2960	18.8	92.5	0.88	3562	17	92.4	0.88
FLSES 160 M	15	2940	27.8	92.0	0.89	2956	25.7	92.7	0.87	3556	23	93.2	0.88
FLSES 160 LUR	18.5	2935	34.1	92.4	0.89	2952	31.8	92.7	0.87	3558	28.4	93.2	0.87
FLSES 180 MUR	22	2945	40	93.0	0.90	2958	37.1	93.8	0.88	3560	33.1	93.8	0.88
FLSES 200 LU	30	2945	55.3	93.5	0.88	2954	51.7	94.0	0.86	3554	46.4	94.0	0.87
FLSES 200 LU	37	2935	67.6	93.7	0.89	2950	62.8	94.3	0.87	3552	56.3	94.2	0.88
FLSES 225 MR	45	2940	81.7	94.0	0.89	2956	75.7	94.6	0.87	3558	68.1	94.6	0.88
FLSES 250 M	55	2966	99.1	94.3	0.89	2972	87.2	94.6	0.87	3574	83.3	94.3	0.88
FLSES 280 S	75	2962	132	94.7	0.91	2968	122	95.2	0.90	3566	110	94.1	0.91
FLSES 280 M	90	2961	158	95.0	0.91	2971	146	95.5	0.90	3567	132	95.0	0.90
FLSES 315 S	110	2972	195	95.2	0.90	2977	178	95.5	0.90	3575	161	95.0	0.90
FLSES 315 M	132	2971	233	95.7	0.90	2976	213	96.0	0.90	3575	193	95.4	0.90
FLSES 315 LA	160	2971	281	96.0	0.90	2976	260	96.2	0.89	3575	233	95.8	0.90
FLSES 315 LB	200	2969	351	96.3	0.90	2974	324	96.6	0.89	3575	291	95.8	0.90
FLSES 355 LA	250	2976	445	95.9	0.89	2982	411	96.2	0.88	3578	372	95.8	0.88
FLSES 355 LB	315	2979	562	95.8	0.89	2985	524	96.2	0.87	3583	469	95.8	0.88
FLSES 355 LC	355	2977	640	95.8	0.88	2983	596	96.3	0.86	3581	535	95.8	0.87
FLSES 355 LD	400	2987	694	97.0	0.90	2991	647	96.8	0.89	3589	585	96.5	0.89
4 poles													
FLSES 80 LG	0.75	1450	1.65	82.6	0.83	1454	1.6	83.4	0.78	1758	1.45	85.4	0.76
FLSES 90 SL	1.1	1450	2.35	84.1	0.84	1454	2.3	84.9	0.79	1758	2.05	86.4	0.78
FLSES 90 LU	1.5	1454	3.25	85.3	0.82	1458	3.15	85.9	0.77	1762	2.8	87.3	0.77
FLSES 100 LR	2.2	1452	4.7	86.7	0.81	1456	4.65	87.1	0.76	1762	4.1	88.3	0.76
FLSES 100 LG	3	1460	6.2	87.7	0.84	1462	6.05	88.4	0.78	1766	5.35	90.0	0.79
FLSES 112 MU	4	1458	8.3	88.6	0.83	1462	8.05	88.9	0.78	1764	7.45	89.5	0.79
FLSES 132 SM	5.5	1462	10.9	89.6	0.86	1466	10.3	90.2	0.82	1768	9.25	91.2	0.82
FLSES 132 MR	7.5	1460	14.5	90.4	0.87	1464	13.5	91.0	0.85	1768	12.2	91.7	0.85
FLSES 160 M	9	1468	17.3	90.9	0.87	1472	16.4	91.7	0.83	1772	14.6	92.4	0.84
FLSES 160 M	11	1466	21	91.4	0.87	1468	19.5	92.2	0.85	1772	17.5	92.9	0.85
FLSES 160 LUR	15	1470	28.7	92.1	0.87	1474	26.9	92.6	0.84	1774	24.1	93.3	0.84
FLSES 180 M	18.5	1470	35.6	92.6	0.86	1472	33.5	93.0	0.83	1774	29.9	93.6	0.83
FLSES 180 LUR	22	1470	42.4	93.0	0.85	1474	40.1	93.4	0.82	1776	36.3	93.8	0.81
FLSES 200 LU	30	1474	56.8	93.6	0.85	1476	53.7	94.2	0.82	1780	48.3	94.5	0.83
FLSES 225 S	37	1484	70.4	93.9	0.85	1486	65.8	94.5	0.83	1786	59.4	94.5	0.83
FLSES 225 M	45	1484	85.9	94.3	0.84	1486	80.7	95.0	0.82	1788	72.2	95.1	0.82
FLSES 250 MR	55	1482	105	94.6	0.84	1484	98.4	95.0	0.82	1784	88.3	95.3	0.82
FLSES 280 S	75	1483	142	94.7	0.85	1486	133	94.8	0.83	1784	117	95.4	0.84
FLSES 280 M	90	1481	168	95.0	0.86	1485	159	95.1	0.83	1783	141	95.4	0.84
FLSES 315 S	110	1486	204	95.4	0.86	1487	194	95.4	0.83	1786	172	95.8	0.84
FLSES 315 M	132	1484	241	95.6	0.87	1487	229	95.8	0.84	1787	203	96.0	0.85
FLSES 315 LA	160	1482	292	95.8	0.87	1486	276	96.1	0.84	1784	249	96.2	0.85
FLSES 315 LB	200	1483	364	96.0	0.87	1487	345	96.0	0.84	1786	307	96.2	0.85
FLSES 355 LA	250	1487	450	96.0	0.88	1490	425	96.2	0.85	1788	379	96.2	0.86
FLSES 355 LAL	280	1487	503	96.0	0.88	1488	471	96.1	0.86	1787	420	96.2	0.87
FLSES 355 LB	315	1488	567	96.0	0.88	1489	530	96.3	0.86	1787	472	96.2	0.87
FLSES 355 LC	355	1487	631	96.0	0.89	1488	592	96.0	0.87	1786	532	96.2	0.87
FLSES 355 LD	400	1488	736	96.3	0.86	1489	690	96.6	0.84	1790	607	96.2	0.86
6 poles													
FLSES 90 SL	0.75	945	1.9	78.9	0.75	956	1.9	79.5	0.70	-	-	-	-
FLSES 90 LU	1.1	945	2.8	81.0	0.74	958	2.75	81.8	0.68	-	-	-	-
FLSES 100 LG	1.5	962	3.65	83.0	0.75	970	3.55	83.8	0.70	-	-	-	-
FLSES 112 MU	2.2	962	5.4	84.3	0.73	972	5.35	84.7	0.68	-	-	-	-
FLSES 132 SM	3	970	7	85.6	0.76	974	6.85	86.0	0.71	-	-	-	-
FLSES 132 M	4	966	9.3	86.8	0.75	972	9.15	87.9	0.69	-	-	-	-
FLSES 132 MU	5.5	962	12.1	88.0	0.78	970	11.7	88.5	0.74	-	-	-	-
FLSES 160 MU	7.5	974	18.1	89.1	0.79	980	17.1	89.6	0.74	-	-	-	-
FLSES 180 L	11	978	23.2	90.6	0.79	984	22.3	91.2	0.75	-	-	-	-
FLSES 180 LUR	15	976	32.7	91.2	0.76	982	31.7	91.4	0.72	-	-	-	-
FLSES 200 LU	18.5	974	37.8	91.7	0.81	980	36	92.1	0.78	-	-	-	-
FLSES 200 LU	22	978	43.8	92.2	0.79	984	40.5	92.7	0.77	-	-	-	-
FLSES 225 M	30	984	57.3	92.9	0.86	986	53.9	93.3	0.83	-	-	-	-
FLSES 250 M	37	984	70.5	93.4	0.85	986	67	93.7	0.82	-	-	-	-
FLSES 280 S	45	984	84	93.7	0.87	987	80	94.2	0.84	1186	71	94.5	0.85
FLSES 280 M	55	985	103	94.1	0.86	988	99	94.4	0.82	1186	87	94.5	0.84
FLSES 315 S	75	989	146	95.0	0.83	992	139	95.1	0.79	1190	122	95.0	0.81
FLSES 315 M	90	987	172	94.9	0.84	992	166	95.2	0.79	1191	145	95.0	0.82
FLSES 315 LA	110	987	209	95.1	0.84	992	203	95.4	0.79	1191	176	95.8	0.82
FLSES 315 LB	132	988	256	95.4	0.82	991	243	95.7	0.79	1190	217	95.8	0.80
FLSES 355 LA	160	992	295	95.8	0.86	994	276	96.0	0.84	1193	247	95.8	0.85
FLSES 355 LB	200	991	374	95.8	0.85	994	350	95.9	0.83	1193	312	95.8	0.84
FLSES 355 LC	250	991	484	95.8	0.82	994	454	95.9	0.80	1193	405	95.8	0.81
FLSES 355 LKA	315	991	602	95.8	0.83	994	565	95.8	0.81	1193	504	95.8	0.82
FLSES 355 LKB	355	990	671	95.8	0.84	993	629	95.8	0.82	1192	561	95.8	0.83

IMfinity® 3-phase induction motors - High efficiency & Premium efficiency

IP55 Cast Iron frame

Electrical and mechanical characteristics

IE3 powered by the drive

Type	400 V 50 Hz				% Rated torque M _n at					400 V 87 Hz Δ ¹				Maximum mechanical speed ²
	Rated power	Rated speed	Rated current	Power factor	10 Hz	17 Hz	25 Hz	50 Hz	87 Hz	Rated power	Rated speed	Rated current	Power factor	
	P _n kW	N _n min ⁻¹	I _n A	Cos φ 4/4						P _n kW	N _n min ⁻¹	I _n A	Cos φ 4/4	
2 poles														
FLSES 80 L	0.75	2845	1.75	0.83	90%	100%	100%	100%	57%	1.31	5065	3.04	0.83	13500
FLSES 80 LG	1.1	2845	2.46	0.85	85%	100%	100%	100%	57%	1.91	5065	4.29	0.85	13500
FLSES 90 SL	1.5	2850	3.4	0.85	85%	100%	100%	100%	57%	2.61	5070	5.9	0.85	11700
FLSES 90 LU	2.2	2850	4.72	0.86	85%	100%	100%	100%	57%	3.83	5070	8.22	0.86	11700
FLSES 100 L	3	2855	6.45	0.86	85%	100%	100%	100%	57%	5.22	5075	11.26	0.86	9900
FLSES 112 MG	4	2900	8.5	0.87	85%	100%	100%	100%	57%	6.96	5120	14.74	0.87	9900
FLSES 132 SM	5.5	2910	11.6	0.87	85%	100%	100%	100%	57%	9.57	5130	20.19	0.87	6700
FLSES 132 SM	7.5	2915	15.5	0.86	85%	95%	100%	100%	57%	13.05	5135	26.98	0.86	6700
FLSES 160 M	11	2945	21.9	0.89	85%	95%	100%	100%	57%	19.14	5165	38.24	0.89	6030
FLSES 160 M	15	2935	30.1	0.88	85%	95%	100%	100%	57%	26.1	5155	52.36	0.88	6030
FLSES 160 LUR	18.5	2925	37.4	0.88	85%	95%	100%	100%	-	-	-	-	-	4500
FLSES 180 MUR	22	2935	43.5	0.89	85%	95%	100%	100%	-	-	-	-	-	5670
FLSES 200 LU	30	2935	59.6	0.87	85%	90%	100%	100%	-	-	-	-	-	4500
FLSES 200 LU	37	2920	73.9	0.88	80%	90%	100%	100%	-	-	-	-	-	4700
FLSES 225 MR	45	2930	88.6	0.88	80%	90%	100%	100%	-	-	-	-	-	4320
FLSES 250 M	55	2960	107.8	0.88	80%	90%	100%	100%	-	-	-	-	-	4050
FLSES 280 S	75	2960	135	0.91	75%	85%	100%	100%	-	-	-	-	-	3580
FLSES 280 M	90	2961	164	0.91	75%	85%	100%	100%	-	-	-	-	-	3580
FLSES 315 S	110	2972	202	0.90	75%	85%	100%	100%	-	-	-	-	-	3580
FLSES 315 M	132	2972	243	0.90	75%	85%	100%	100%	-	-	-	-	-	3580
FLSES 315 LA	160	2971	193	0.90	75%	85%	100%	100%	-	-	-	-	-	3580
FLSES 315 LB	200	2971	365	0.90	75%	85%	100%	100%	-	-	-	-	-	3580
FLSES 355 LA	250	2976	461	0.89	73%	96%	100%	100%	-	-	-	-	-	3580
FLSES 355 LB	315	2979	538	0.89	75%	85%	100%	100%	-	-	-	-	-	3580
FLSES 355 LC	355	2977	663	0.88	75%	85%	100%	100%	-	-	-	-	-	3580
4 poles														
FLSES 80 LG	0.75	1435	1.8	0.80	90%	100%	100%	100%	57%	1.31	2545	3.13	0.80	13500
FLSES 90 SL	1.1	1430	2.6	0.81	90%	100%	100%	100%	57%	1.91	2540	4.47	0.81	11700
FLSES 90 LU	1.5	1435	3.5	0.79	90%	100%	100%	100%	57%	2.61	2545	6.08	0.79	11700
FLSES 100 LR	2.2	1440	5	0.79	90%	100%	100%	100%	57%	3.83	2550	8.76	0.79	9900
FLSES 100 LG	3	1445	6.7	0.81	90%	100%	100%	100%	57%	5.22	2555	11.71	0.81	9900
FLSES 112 MU	4	1440	8.8	0.80	90%	100%	100%	100%	57%	6.96	2550	15.37	0.80	9900
FLSES 132 SM	5.5	1450	11.6	0.84	90%	90%	100%	100%	57%	9.57	2560	20.19	0.84	6700
FLSES 132 MR	7.5	1445	15.7	0.86	90%	90%	100%	100%	57%	13.05	2555	27.34	0.86	6700
FLSES 160 M	11	1454	22.7	0.86	85%	95%	100%	100%	57%	19.14	2564	39.49	0.86	6030
FLSES 160 LUR	15	1458	30.7	0.85	85%	95%	100%	100%	57%	26.1	2568	53.43	0.85	5670
FLSES 180 M	18.5	1458	38.3	0.84	80%	90%	100%	100%	57%	32.19	2568	66.66	0.84	5670
FLSES 180 LUR	22	1460	46	0.83	80%	90%	100%	100%	57%	38.28	2570	80.06	0.83	4500
FLSES 200 LU	30	1466	61.7	0.84	85%	95%	100%	100%	57%	52.2	2576	107.4	0.84	4500
FLSES 225 S	37	1476	76.1	0.84	85%	95%	100%	100%	57%	64.38	2586	132.42	0.84	4320
FLSES 225 M	45	1478	92.9	0.83	85%	95%	100%	100%	57%	78.3	2588	161.73	0.83	4320
FLSES 250 MR	55	1476	114	0.83	85%	95%	100%	100%	57%	95.7	2586	198.36	0.83	4050
FLSES 280 S	75	1485	148	0.84	75%	85%	100%	100%	56%	75	2610	148	0.84	2610
FLSES 280 M	90	1485	177	0.84	75%	85%	100%	100%	57%	90	2610	177	0.84	2610
FLSES 315 S	110	1486	210	0.86	90%	100%	100%	100%	57%	110	2610	210	0.86	2610
FLSES 315 M	132	1487	250	0.87	96%	97%	100%	100%	57%	132	2610	250	0.87	2610
FLSES 315 LA	160	1484	303	0.87	91%	94%	100%	100%	57%	160	2610	303	0.87	2610
FLSES 315 LB	200	1486	374	0.87	89%	93%	100%	100%	55%	200	2610	374	0.87	2610
FLSES 355 LA	250	1488	465	0.87	93%	95%	100%	100%	57%	250	2610	465	0.87	2610
FLSES 355 LAL	280	1487	507	0.87	92%	95%	100%	100%	58%	280	2610	507	0.87	2610
FLSES 355 LB	315	1488	594	0.87	75%	85%	100%	100%	57%	315	2610	594	0.87	2610
FLSES 355 LC	355	1487	670	0.87	75%	85%	100%	100%	57%	355	2610	670	0.87	2610
6 poles														
FLSES 90 SL	0.75	930	2.05	0.72	100%	100%	100%	100%	57%	1.31	1670	3.57	0.72	11700
FLSES 90 LU	1.1	935	3.9	0.71	100%	100%	100%	100%	57%	1.91	1675	5.09	0.71	11700
FLSES 100 LG	1.5	954	3.9	0.72	100%	100%	100%	100%	57%	2.61	1694	6.79	0.72	9900
FLSES 112 MU	2.2	954	5.75	0.70	100%	100%	100%	100%	57%	3.83	1694	10.01	0.70	9900
FLSES 132 SM	3	962	7.3	0.73	100%	100%	100%	100%	57%	5.22	1702	12.69	0.73	6700
FLSES 132 M	4	960	9.9	0.72	100%	100%	100%	100%	57%	6.96	1700	17.24	0.72	6700
FLSES 132 MU	5.5	954	13.05	0.76	100%	100%	100%	100%	57%	9.57	1694	22.7	0.76	6700
FLSES 160 MU	7.5	970	17.35	0.77	100%	100%	100%	100%	57%	13.05	1710	30.2	0.77	6030
FLSES 180 L	11	976	24.65	0.77	95%	100%	100%	100%	57%	19.14	1716	42.89	0.77	5670
FLSES 180 LUR	15	972	35.2	0.74	80%	90%	100%	100%	57%	26.1	1712	61.3	0.74	4500
FLSES 200 LU	18.5	970	40.5	0.79	80%	90%	100%	100%	57%	32.19	1710	70.59	0.79	4500
FLSES 200 LU	22	976	48.7	0.77	80%	90%	100%	100%	57%	38.28	1716	84.71	0.77	4500
FLSES 225 M	30	980	61.7	0.84	90%	100%	100%	100%	57%	52.2	1720	107.4	0.84	4050
FLSES 250 M	37	982	75.4	0.84	90%	100%	100%	100%	57%	64.38	1722	131.17	0.84	4050
FLSES 280 S	45	986	89	0.85	75%	85%	100%	100%	57%	45	1740	89	0.85	1740
FLSES 280 M	55	986	108	0.9	75%	85%	100%	100%	57%	55	1740	108	0.85	1740
FLSES 315 S	75	990	155	0.8	75%	85%	100%	100%	54%	75	1740	155	0.80	1740
FLSES 315 M	90	991	187	0.8	75%	85%	100%	100%	57%	90	1740	187	0.80	1740
FLSES 315 LA	110	991	228	0.8	75%	85%	100%	100%	57%	110	1740	228	0.80	1740
FLSES 315 LB	132	990	272	0.8	75%	85%	100%	100%	57%	132	1740	272	0.80	1740
FLSES 355 LA	160	993	310	0.85	75%	85%	100%	100%	57%	160	1740	310	0.85	1740
FLSES 355 LB	200	993	391	0.84	75%	85%	100%	100%	57%	200	1740	391	0.84	1740
FLSES 355 LC	250	993	507	0.81	75%	85%	100%	100%	57%	250	1740	507	0.81	1740
FLSES 355 LKA	315	993	631	0.82	75%	85%	100%	100%	57%	315	1740	631	0.82	1740
FLSES 355 LKB	355	992	703	0.83	75%	85%	100%	100%	57%	355	1740	703	0.83	1740

(1) Data only valid for: 400 V 50 Hz Y motors and frame size ≤ 250 mm - 2 poles

(2) See Vibrations section on page 48

 - Please refer to page 38 for variable speed applications
 - Values given with a voltage drop of 30 V at the drive output

IP55 CAST IRON MOTORS

IMfinity® 3-phase induction motors - High efficiency & Premium efficiency

IP55 Cast Iron frame

Electrical and mechanical characteristics

IE3 powered by the drive

Summary of recommended protection devices

Mains voltage	Cable length	Frame size	Winding protection	Insulated bearings
≤ 480 V	< 20 m	All frame sizes	Standard	No
	> 20 m and < 100 m	< 315	Standard	No
		≥ 315	RIS or drive filter	NDE
> 480 V and ≤ 690 V	< 20 m	< 250	Standard	No
		≥ 250	RIS or drive filter	NDE
	> 20 m and < 100 m	< 250	RIS or drive filter	NDE
		≥ 250	RIS or drive filter	NDE
		≥ 250	RIS or drive filter	NDE (or DE+NDE if no filter for ≥ 315)

RIS: Reinforced Insulation System.

The filter is recommended above frame size 315.

Standard insulation = 1500 V peak and 3500 V/μs.

Service solutions exist (insulation for winding and bearings).

For different cable length(s) and/or voltage(s), please consult Leroy-Somer.



REMINDER: All 2, 4 and 6 pole motors placed on the EU market must be IE3 or IE2 and used with a variable speed drive:

- from 01/01/2015 for power ratings from 7.5 to 375 kW
- from 01/01/2017 for power ratings from 0.75 to 375 kW

Other drive mechanism solutions:



LSRPM: permanent magnet synchronous motors 0.75 to 375 kW

Variable speed application, requiring IP55 protection, high efficiency and/or compact dimensions.



CPLS: induction motors 95 to 1600 Nm

Application for variable speed operation requiring constant power over a wide speed range.



LSMV: induction motors 0.25 to 132 kW

Application for variable speed operation requiring constant torque over a wide speed range.



LSK: D.C. motors 2 to 750 kW



UNIMOTOR FM and HD: servomotors 0.7 to 410 Nm

IMfinity® 3-phase induction motors - High efficiency & Premium efficiency

IP55 Cast Iron frame

Electrical and mechanical characteristics

Mains connection

DESCRIPTIVE TABLE OF TERMINAL BOXES FOR 400 V RATED SUPPLY VOLTAGE (in accordance with EN 50262)

Series	Type	No. of poles	Terminal box material	Power + auxiliaries	
				Number of drill holes	Drill hole diameter*
FLSES	80	2; 4	Cast iron	1 (2 if auxiliaries)	ISO M20 x 1.5
	90	2; 4; 6			
	100	2; 4; 6		2	ISO M25 x 1.5
	112	2; 4; 6			
	132	2; 4; 6		0	Removable undrilled mounting plate
	160	2; 4; 6			
	180	2; 4; 6			
	200	2; 4; 6			
	225	2; 4; 6			
	250	2; 4; 6			
	280	2; 4; 6			
315	2; 4; 6				
FLSES/FLS	355/400/450	2; 4; 6			

* As an option, both ISO M25 cable glands may be replaced by 1 ISO x M25 and 1 ISO x M32 (to comply with standard DIN 42925).

TERMINAL BLOCKS DIRECTION OF ROTATION

Standard motors are fitted with a block of 6 terminals complying with standard NFC 51 120, with the terminal markings complying with IEC 60034-8 (or NF EN 60034-8).

When the motor is running in U1, V1, W1 or 1U, 1V, 1W from a direct mains supply L1, L2, L3, it turns clockwise when seen from the drive shaft end.

If any two of the phases are changed over, the motor will run in an anti-clockwise direction (make sure that the motor has been designed to run in both directions).

If the motor is fitted with accessories (thermal protection or space heater), these must be connected on screw dominos with labelled wires.

Series	Type	230/400 V connections		400/690 V connections
		No. of poles	Terminals	Terminals
FLSES	80 to 112	2; 4; 6	M5	M5
	132 S to 160	2; 4; 6	M6	M6
	180 L	6	M6	M6
	180 M	4	M8	M6
	180 LUR	6	M6	M6
	180 MUR	2; 4	M8	M6
	200 LU	2 (30 kW); 4; 6	M8	M8
		2 (37 kW)	M10	M8
	225 M	4	M10	M8
		6	M8	
	225 to 250	2	M10	M8
		4		M10
	250 M	6	M8	M8
	280 to 315	2; 4; 6	M12	M12
355 L	2; 4; 6	M12	M12	
FLSES/FLS	355 LK	4; 6	M14	M14
FLS	400/450	4; 6	M14	M14

Tightening torque for the nuts on the terminal blocks

Terminal	M5	M6	M8	M10	M12	M14	M16
Torque N.m	2.5	4	10	20	35	50	65

IMfinity® 3-phase induction motors - High efficiency & Premium efficiency

IP55 Cast Iron frame

Dimensions

Shaft extensions

Dimensions in millimetres

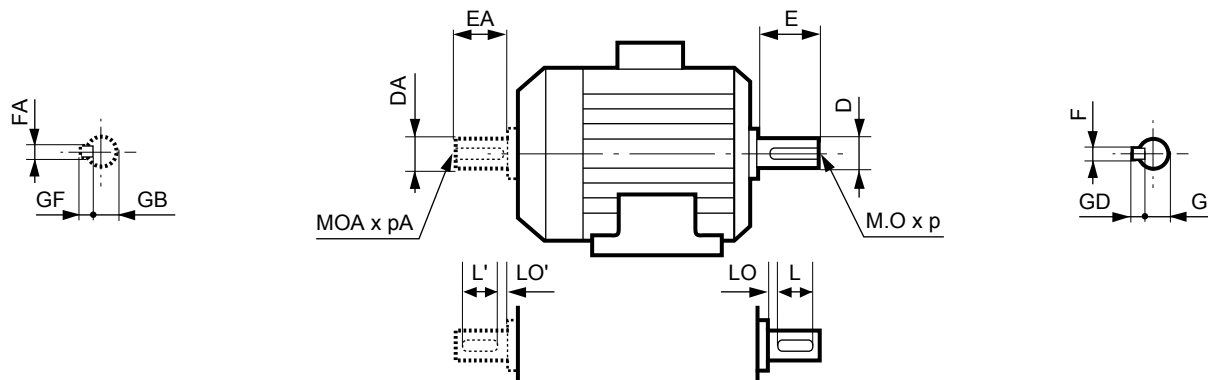

Type	Main shaft extensions																	
	4 and 6 poles								2 poles									
	F	GD	D	G	E	O	p	L	LO	F	GD	D	G	E	O	p	L	LO
FLSES 80 L/LG	6	6	19j6	15.5	40	6	16	30	6	6	6	19j6	15.5	40	6	16	30	6
FLSES 90 S/L/LU	8	7	24j6	20	50	8	19	40	6	8	7	24j6	20	50	8	19	40	6
FLSES 90 SL	8	7	24j6	20	50	8	19	40	6	8	7	24j6	20	50	8	19	40	6
FLSES 100 L/LK	8	7	28j6	24	60	10	22	50	6	8	7	28j6	24	60	10	22	50	6
FLSES 100 LG	8	7	28j6	24	60	10	22	50	6	8	7	28j6	24	60	10	22	50	6
FLSES 100 LR	8	7	28j6	24	60	10	22	50	6	8	7	28j6	24	60	10	22	50	6
FLSES 112 M/MG/MU	8	7	28j6	24	60	10	22	50	6	8	7	28j6	24	60	10	22	50	6
FLSES 132 S/M/MR/MU	10	8	38k6	33	80	12	28	63	10	10	8	38k6	33	80	12	28	63	10
FLSES 132 SM	10	8	38k6	33	80	12	28	63	10	10	8	38k6	33	80	12	28	63	10
FLSES 160 M/L/LU	12	8	42k6	37	110	16	36	100	6	12	8	42k6	37	110	16	36	90	6
FLSES 160 MU	12	8	42k6	37	110	16	36	90	20	12	8	42k6	37	110	16	36	90	20
FLSES 160 LUR	12	8	42k6	37	110	16	36	90	20	12	8	42k6	37	110	16	36	90	20
FLSES 180 MT	14	9	48k6	42.5	110	16	36	90	20	14	9	48k6	42.5	110	16	36	90	20
FLSES 180 MUR	14	9	48k6	42.5	110	16	36	90	20	14	9	48k6	42.5	110	16	36	98	12
FLSES 180 M/MR/L/LUR	14	9	48k6	42.5	110	16	36	98	12	14	9	48k6	42.5	110	16	36	98	12
FLSES 200 LU	16	10	55m6	49	110	20	42	90	20	16	10	55m6	49	110	20	42	90	20
FLSES 225 SR/MR/S	18	11	60m6	53	140	20	42	125	15	16	10	55m6	49	110	20	42	90	20
FLSES 225 SG	18	11	60m6	53	140	20	42	125	15	16	10	55m6	49	110	20	42	125	15
FLSES 250 M	18	11	65m6	58	140	20	42	125	15	18	11	60m6	53	140	20	42	125	15
FLSES 250 MR	18	11	65m6	58	140	20	42	125	15	18	11	65m6	58	140	20	42	125	15
FLSES 280 S/M	20	12	75m6	67.5	140	20	42	125	15	18	11	65m6	58	140	20	42	125	15
FLSES 315 S/M	22	14	80m6	71	170	20	42	140	30	18	11	65m6	58	140	20	42	125	15
FLSES 315 LA/LB	25	14	90m6	81	170	24	50	140	30	20	12	70m6	62.5	140	20	42	125	15
FLSES 355 LAL	28	16	100m6	90	210	24	50	180	30	-	-	-	-	-	-	-	-	-
FLSES/FLS 355 L/LK	28	16	100m6	90	210	24	50	180	30	22	14	80m6	71	170	20	42	140	30
FLS 400 L/LK/LV	28	16	110m6	100	210	24	50	180	30	-	-	-	-	-	-	-	-	-
FLS 450 L/LV	32	18	120m6	109	210	24	50	180	30	-	-	-	-	-	-	-	-	-

Type	Secondary shaft extensions																	
	4 and 6 poles								2 poles									
	FA	GF	DA	GB	EA	OA	pA	L'	LO'	FA	GF	DA	GB	EA	OA	pA	L'	LO'
FLSES 80 L/LG	5	5	14j6	11	30	5	15	25	3.5	5	5	14j6	11	30	5	15	25	3.5
FLSES 90 S/L/LU	6	6	19j6	15.5	40	6	16	30	6	6	6	19j6	15.5	40	6	16	30	6
FLSES 90 SL	6	6	19j6	15.5	40	6	16	30	6	6	6	19j6	15.5	40	6	16	30	6
FLSES 100 L/LK	8	7	24j6	20	50	8	19	40	6	8	7	24j6	20	50	8	19	40	6
FLSES 100 LG	8	7	24j6	20	50	8	19	40	6	8	7	24j6	20	50	8	19	40	6
FLSES 100 LR	8	7	24j6	20	50	8	19	40	6	8	7	24j6	20	50	8	19	40	6
FLSES 112 M/MG/MU	8	7	24j6	20	50	8	19	40	6	8	7	24j6	20	50	8	19	40	6
FLSES 132 S/M/MR/MU	8	7	28k6	24	60	10	22	50	6	8	7	28k6	24	60	10	22	50	6
FLSES 132 SM	8	7	28k6	24	60	10	22	50	6	8	7	28k6	24	60	10	22	50	6
FLSES 160 M/L/LU	12	8	42k6	37	110	16	36	100	6	12	8	42k6	37	110	16	36	100	6
FLSES 160 MU	12	8	42k6	37	110	16	36	100	6	12	8	42k6	37	110	16	36	100	6
FLSES 160 LUR	12	8	42k6	37	110	16	36	90	20	12	8	42k6	37	110	16	36	90	20
FLSES 180 MT	14	9	48k6	42.5	110	16	36	90	20	14	9	48k6	42.5	110	16	36	90	20
FLSES 180 MUR	14	9	48k6	42.5	110	16	36	90	20	14	9	48k6	42.5	110	16	36	90	20
FLSES 180 M/MR/L/LUR	14	9	48k6	42.5	110	16	36	98	12	14	9	48k6	42.5	110	16	36	98	12
FLSES 200 LU	16	10	55m6	49	110	20	42	90	20	16	10	55m6	49	110	20	42	90	20
FLSES 225 SR/MR/S	18	11	60m6	53	140	20	42	125	15	16	10	55m6	49	110	20	42	90	20
FLSES 225 SG	18	11	60m6	53	140	20	42	125	15	16	10	55m6	49	110	20	42	125	15
FLSES 250 M	18	11	60m6	53	140	20	42	125	15	18	11	60m6	53	140	20	42	125	15
FLSES 250 MR	18	11	60m6	53	140	20	42	125	15	18	11	60m6	53	140	20	42	125	15
FLSES 280 S/M	20	12	60m6	53	140	20	42	125	15	18	11	60m6	53	140	20	42	125	15
FLSES 315 S/M	20	12	70m6	62.5	140	20	42	125	15	18	11	65m6	58	140	20	42	125	15
FLSES 315 L	20	12	70m6	62.5	140	20	42	125	15	20	12	70m6	62.5	140	20	42	125	15
FLSES 355 LA/LB/LC/LD	20	12	70m6	62.5	140	20	42	125	15	20	12	70m6	62.5	140	20	42	125	15
FLSES 355 LAL	28	16	100m6	90	210	24	50	180	30	-	-	-	-	-	-	-	-	-
FLSES/FLS 355 LK	28	16	100m6	90	210	24	50	180	30	22	14	80m6	71	170	20	42	140	30
FLS 400 L/LK/LV	28	16	110m6	100	210	24	50	180	30	-	-	-	-	-	-	-	-	-
FLS 450 L/LV	32	18	120m6	109	210	24	50	180	30	-	-	-	-	-	-	-	-	-

IP55 CAST IRON MOTORS

IMfinity® 3-phase induction motors - High efficiency & Premium efficiency

IP55 Cast Iron frame

Dimensions

Foot mounted IM 1001 (IM B3)

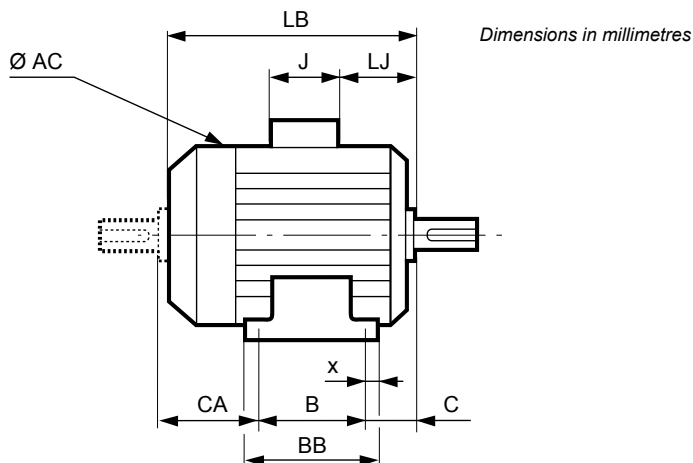
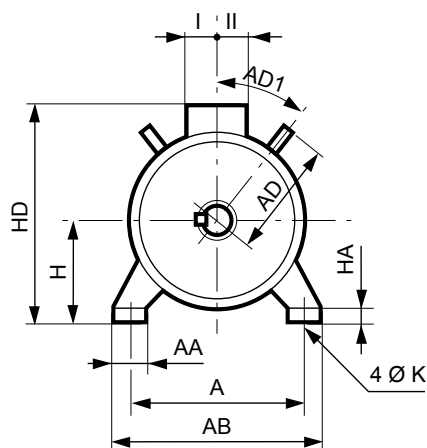

Dimensions in millimetres

Type	Main dimensions																		
	A	AB	B	BB	C	X	AA	K	HA	H	AC*	HD	LB	LJ	J	I	II	AD	AD1
FLSES 80 L	125	157	100	130	50	13	32	10	10	80	170	228	212	7	136	68	68	-	-
FLSES 80 LG	125	157	100	130	52	13	32	10	10	80	185	238	265	9	136	68	68	-	-
FLSES 90 SL	140	170	125	162	56	29	26	9	10	90	185	248	239	8.5	136	68	68	135	40
FLSES 90 S	140	170	100	162	56	27.5	26	10	10	90	185	248	239	8.5	136	68	68	135	40
FLSES 100 L	160	196	140	185	63	29	40	12	13	100	204	258	300	8	136	68	68	270	40
FLSES 100 LG	160	196	140	170	63	11	49	12	13	100	230	264	309	10.5	136	68	68	-	-
FLSES 100 LR	160	196	140	185	63	29	40	12	13	100	204	258	300	8	136	68	68	270	40
FLSES 100 LK	160	200	140	174	63	22	42	12	12	100	226	276.5	319	52	120	60	60	-	-
FLSES 112 M	190	230	140	174	70	32	48	12	12	112	233	294	309	18.5	136	68	68	148	40
FLSES 112 MG	190	230	140	174	70	32	48	12	12	112	233	294	309	18.5	136	68	68	148	40
FLSES 112 MU	190	230	140	174	70	32	48	12	12	112	233	294	305	18.5	136	68	68	148	40
FLSES 132 M	216	255	178	240	89	48	63	12	16	132	262	347	385	23	136	68	68	165	37.5
FLSES 132 MR	216	255	178	240	89	48	63	12	16	132	262	347	447	23	136	68	68	165	37.5
FLSES 132 MU	216	255	178	240	89	48	63	12	16	132	262	347	447	23	136	68	68	165	37.5
FLSES 132 SM	216	255	178	240	89	48	63	12	16	132	262	334	385	23	136	68	68	165	37.5
FLSES 132 S	216	255	140	240	89	48	63	12	16	132	262	347	385	23	136	68	68	165	37.5
FLSES 160 L	254	294	254	294	108	20	65	14.5	20	160	312	440	495	30	246	126	147	-	-
FLSES 160 LU	254	294	254	294	108	20	65	14.5	20	160	312	440	510	30	246	126	147	-	-
FLSES 160 LUR	254	294	254	294	108	20	65	14	20	160	312	440	510	30	246	126	147	178	45
FLSES 160 MU	254	294	210	294	108	20	65	14	20	160	312	440	510	30	246	126	147	178	45
FLSES 160 M	254	294	210	294	108	20	65	14.5	20	160	312	440	495	30	246	126	147	-	-
FLSES 180 L	279	330	279	335	121	28	70	14.5	28	180	350	481	552	43	246	126	147	-	-
FLSES 180 LUR	279	330	279	335	121	28	70	14.5	28	180	350	481	614	42	246	126	147	-	-
FLSES 180 M	279	330	279	335	121	28	70	14.5	28	180	350	481	552	43	246	126	147	-	-
FLSES 180 MT	279	330	241	330	115	28	70	14.5	28	180	350	479	537	36	246	126	147	190	45
FLSES 180 MUR	279	324	241	295	121	25	80	14	25	180	312	460	545	30	246	126	147	178	-
FLSES 180 MR	279	324	241	295	121	25	80	14.5	25	180	312	460	510	30	246	126	147	-	-
FLSES 200 LU	318	374	305	361	133	28	80	18.5	44	200	410	530	669	49	246	126	147	230	45
FLSES 225 S	356	426	286	375	149	32	80	18.5	26	225	540	664	779	69.5	352	173	210	-	-
FLSES 225 M	356	426	311	375	149	32	80	18.5	26	225	540	664	779	69.5	352	173	210	-	-
FLSES 225 MR	356	426	311	375	153.5	32	80	18.5	26	225	410	555	678.5	55.5	246	126	147	230	45
FLSES 225 SR	356	426	286	375	153.5	32	80	18.5	26	225	410	555	678.5	55.5	246	126	147	230	45
FLSES 225 SG	356	426	286	375	160	32	80	18	26	225	410	595	733	9	352	173	210	230	45
FLSES 250 M	406	476	349	413	168	32	80	24	26	250	482	689	779	69.5	352	173	210	-	-
FLSES 250 MR	406	476	349	413	168	32	80	24	26	250	482	689	859	70	352	173	210	270	45
FLSES 280 M	457	527	419	486	190	33	80	24	30	280	481	729	959	69.5	352	176	305	-	45
FLSES 280 S	457	527	368	486	190	33	80	24	30	280	481	729	959	69.5	352	176	305	-	45
FLSES 315 LA	508	600	508	610	216	58	100	28	35	315	600	840	1177	101	452	219	269	343	45
FLSES 315 LB	508	600	508	610	216	58	100	28	35	315	600	840	1177	101	452	219	269	343	45
FLSES 315 M	508	600	457	610	216	58	100	28	35	315	600	840	1177	101	452	219	269	343	45
FLSES 315 S	508	600	406	610	216	58	100	28	35	315	600	840	1177	101	452	219	269	343	45
FLSES 355 LA	610	710	630	756	254	76	100	28	35	355	822	922	1303	121	452	219	269	-	-
FLSES 355 LAL	610	710	630	756	254	76	100	28	35	355	822	925	1303	121	452	219	269	-	-
FLSES 355 LB	610	710	630	756	254	76	100	28	35	355	822	922	1303	121	452	219	269	-	-
FLSES 355 LC/LD	610	710	630	756	254	76	100	28	35	355	822	922	1303	121	452	219	269	-	-
FLSES/FLS 355 LK	610	750	630	815	254	40	128	28	45	355	787	1117	1702	52	700	224	396	-	-
FLS 400 L/LV	686	800	710	815	280	65	128	35	45	400	787	1162	1702	52	700	224	396	-	-
FLS 400 LK	686	824	800	950	280	59	140	35	45	400	877	1210	1740	68	700	224	396	-	-
FLS 450 L/LV	750	890	800	950	315	94	140	35	45	450	877	1260	1740	68	700	224	396	-	-

* AC: housing diameter without lifting rings

IMfinity® 3-phase induction motors - High efficiency & Premium efficiency

IP55 Cast Iron frame

Dimensions

Foot and flange mounted IM 2001 (IM B35)

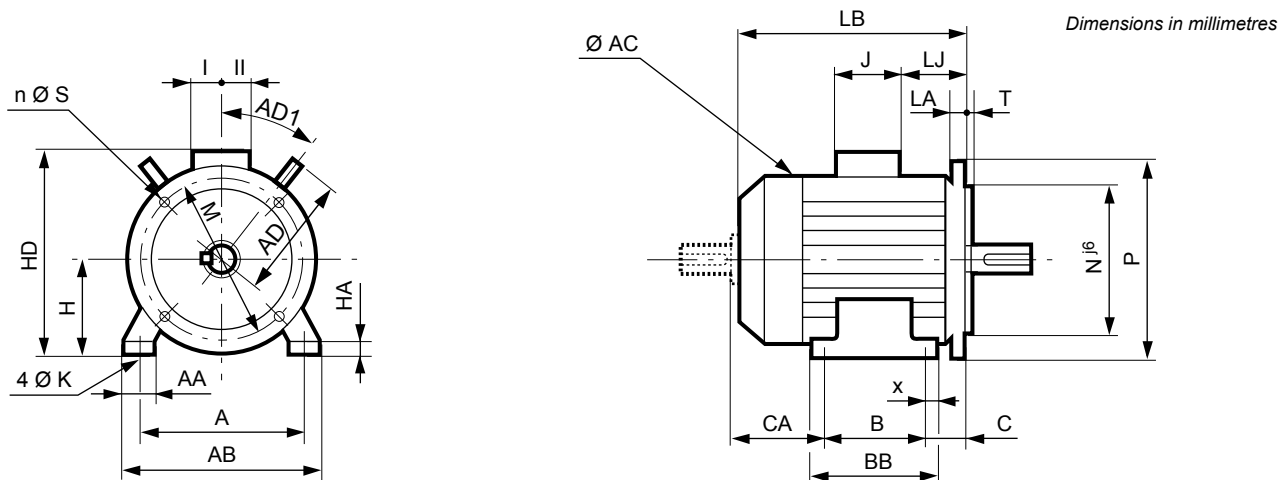

Type	Main dimensions																			Symbol
	A	AB	B	BB	C	X	AA	K	HA	H	AC*	HD	LB	LJ	J	I	II	AD	AD1	
FLSES 80 L	125	157	100	130	50	13	32	10	10	80	170	228	212	7	136	68	68	-	-	FF 165
FLSES 80 LG	125	157	100	130	52	13	32	10	10	80	185	238	265	9	136	68	68	-	-	FF 165
FLSES 90 L	140	170	125	162	56	27.5	26	10	10	90	185	248	261	8.5	136	68	68	135	40	FF 165
FLSES 90 LU	140	170	125	162	76	27.5	26	10	10	90	185	248	288	46	136	68	68	135	40	FF 165
FLSES 90 SL	140	170	125	162	76	29	26	9	10	90	185	248	256	28.5	136	68	68	135	40	FF 165
FLSES 90 S	140	170	100	162	76	27.5	26	10	10	90	185	248	261	46	136	68	68	135	40	FF 165
FLSES 100 L	160	196	140	185	76	29	40	12	13	100	204	258	300	46	136	68	68	270	40	FF 215
FLSES 100 LG	160	196	140	170	63	11	49	12	13	100	230	264	309	10.5	136	68	68	-	-	FF 215
FLSES 100 LR	160	196	140	185	63	29	40	12	13	100	204	258	300	8	136	68	68	270	40	FF 215
FLSES 100 LK	160	200	140	174	63	22	42	12	12	100	226	276.5	319	52	120	60	60	-	-	FF 215
FLSES 112 M	190	230	140	174	70	32	48	12	12	112	233	294	309	18.5	136	68	68	148	40	FF 215
FLSES 112 MG	190	230	140	174	70	32	48	12	12	112	233	294	309	18.5	136	68	68	148	40	FF 215
FLSES 112 MU	190	230	140	174	70	32	48	12	12	112	233	294	305	18.5	136	68	68	148	40	FF 215
FLSES 132 M	216	255	178	240	89	48	63	12	16	132	262	347	385	23	136	68	68	165	37.5	FF 265
FLSES 132 MR	216	255	178	240	89	48	63	12	16	132	262	347	447	23	136	68	68	165	37.5	FF 265
FLSES 132 MU	216	255	178	240	89	48	63	12	16	132	262	347	447	23	136	68	68	165	37.5	FF 265
FLSES 132 SM	216	255	178	240	89	48	63	12	16	132	262	334	385	23	136	68	68	165	37.5	FF 265
FLSES 132 S	216	255	140	240	89	48	63	12	16	132	262	347	385	23	136	68	68	165	37.5	FF 265
FLSES 160 L	254	294	254	294	108	20	65	14.5	20	160	312	440	495	30	246	126	147	-	-	FF 300
FLSES 160 LU	254	294	254	294	108	20	65	14.5	20	160	312	440	510	30	246	126	147	-	-	FF 300
FLSES 160 LUR	254	294	254	294	108	20	65	14	20	160	312	440	510	30	246	126	147	178	45	FF 300
FLSES 160 MU	254	294	210	294	108	20	65	14	20	160	312	440	510	30	246	126	147	178	45	FF 300
FLSES 160 M	254	294	210	294	108	20	65	14.5	20	160	312	440	495	30	246	126	147	-	-	FF 300
FLSES 180 L	279	330	279	335	121	28	70	14.5	28	180	350	481	552	42	246	126	147	-	-	FF 300
FLSES 180 LUR	279	330	279	335	121	28	70	14.5	28	180	350	481	552	42	246	126	147	-	-	FF 300
FLSES 180 M	279	330	279	335	121	28	70	14.5	28	180	350	481	552	42	246	126	147	-	-	FF 300
FLSES 180 MT	279	330	241	330	115	28	70	14.5	28	180	350	479	537	36	246	126	147	190	45	FF 300
FLSES 180 MUR	279	324	241	295	121	25	80	14	25	180	312	460	545	30	246	126	147	178	45	FF 300
FLSES 180 MR	279	324	241	295	121	25	80	14.5	25	180	312	460	510	30	246	126	147	-	-	FF 300
FLSES 200 LU	318	374	305	361	131	28	80	18.5	44	200	410	530	672	49	246	126	147	230	45	FF 350
FLSES 225 S	356	426	286	375	149	32	80	18.5	26	225	540	664	779	69.5	352	173	210	-	-	FF 400
FLSES 225 M	356	426	311	375	149	32	80	18.5	26	225	540	664	779	69.5	352	173	210	-	-	FF 400
FLSES 225 MR	356	426	311	375	153.5	32	80	18.5	26	225	410	555	678.5	55.5	246	126	147	230	45	FF 400
FLSES 225 SR	356	426	286	375	153.5	32	80	18.5	26	225	410	555	678.5	55.5	246	126	147	230	45	FF 400
FLSES 225 SG	356	426	286	375	160	32	80	18.5	26	225	410	595	733	9	352	173	210	230	45	FF 400
FLSES 250 MR	406	476	349	413	168	32	80	22	26	250	475	689	779	69.5	352	173	210	270	45	FF 500
FLSES 280 M	457	527	419	483	190	32	80	24	26	280	540	719	959	69.5	352	173	210	-	-	FF 500
FLSES 280 S	457	527	368	432	190	32	80	24	26	280	540	719	959	69.5	352	173	210	-	-	FF 500
FLSES 315 LA	508	600	508	610	216	58	100	28	35	315	600	840	1177	101	452	219	269	343	45	FF 600
FLSES 315 LB	508	600	508	610	216	58	100	28	35	315	600	840	1177	101	452	219	269	343	45	FF 600
FLSES 315 M	508	600	457	610	216	58	100	28	35	315	600	840	1177	101	452	219	269	343	45	FF 600
FLSES 315 S	508	600	406	610	216	58	100	28	35	315	600	840	1177	101	452	219	269	343	45	FF 600
FLSES 355 LA	610	710	630	756	254	76	100	28	35	355	822	922	1303	121	452	219	269	-	-	FF 740
FLSES 355 LAL	610	710	630	756	254	76	100	28	35	355	822	925	1303	121	452	219	269	-	-	FF 740
FLSES 355 LB	610	710	630	756	254	76	100	28	35	355	822	922	1303	121	452	219	269	-	-	FF 740
FLSES 355 LC/LD	610	710	630	756	254	76	100	28	35	355	822	922	1303	121	452	219	269	-	-	FF 740
FLSES/FLS 355 LK	610	750	630	815	254	40	128	28	45	355	787	1117	1702	52	700	224	396	-	-	FF 740
FLS 400 L/LV	686	800	710	815	280	65	128	35	45	400	787	1162	1702	52	700	224	396	-	-	FF 940
FLS 400 LK	686	824	800	950	280	59	140	35	45	400	877	1210	1740	68	700	224	396	-	-	FF 940
FLS 450 L/LV	750	890	800	950	315	94	140	35	45	450	877	1260	1740	68	700	224	396	-	-	FF 1080

* AC: housing diameter without lifting rings

IP55 CAST IRON MOTORS

IMfinity® 3-phase induction motors - High efficiency & Premium efficiency

IP55 Cast Iron frame

Dimensions

Flange mounted IM 3001 (IM B5) IM 3011 (IM V1)

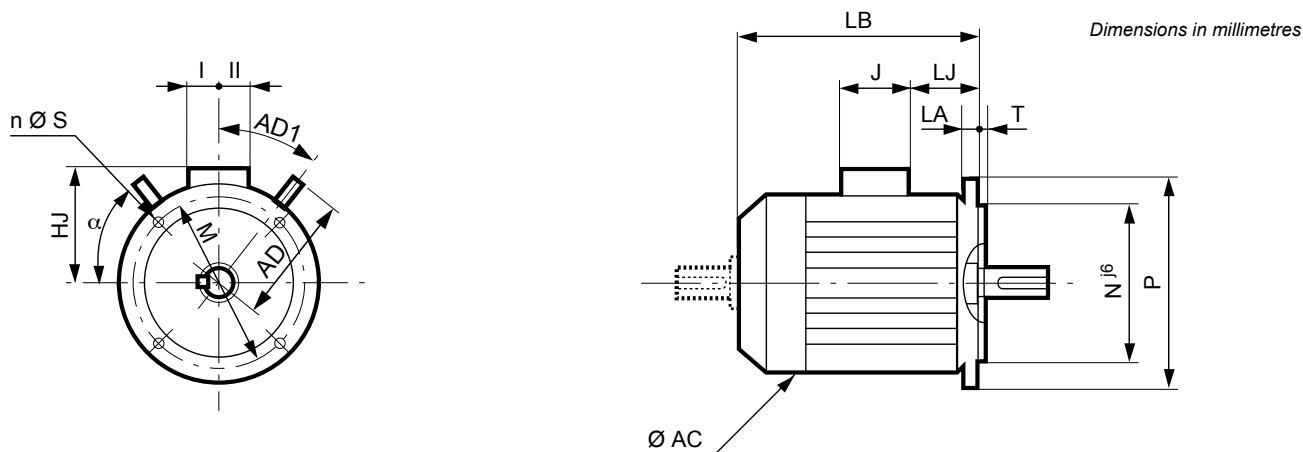

IP55 CAST IRON MOTORS

Symbol IEC	Flange dimensions								
	M	N	P	T	n	α°	S	LA	
FF 165	165	130	200	3.5	4	45	12	10	
FF 165	165	130	200	3.5	4	45	12	10	
FF 165	165	130	200	3.5	4	45	12	10	
FF 165	165	130	200	3.5	4	45	12	10	
FF 165	165	130	200	3.5	4	45	12	10	
FF 165	165	130	200	3.5	4	45	12	10	
FF 215	215	180	250	4	4	45	14.5	12	
FF 215	215	180	250	4	4	45	14.5	12	
FF 215	215	180	250	4	4	45	15	12	
FF 215	215	180	250	4	4	45	14.5	12	
FF 215	215	180	250	4	4	45	14.5	12	
FF 215	215	180	250	4	4	45	14.5	12	
FF 215	215	180	250	4	4	45	14.5	11	
FF 265	265	230	300	4	4	45	14.5	12	
FF 265	265	230	300	4	4	45	14.5	12	
FF 265	265	230	300	4	4	45	14.5	12	
FF 265	265	230	300	4	4	45	14.5	14	
FF 265	265	230	300	4	4	45	14.5	12	
FF 300	300	250	350	5	4	45	18.5	14	
FF 300	300	250	350	5	4	45	18.5	14	
FF 300	300	250	350	5	4	45	18.5	14	
FF 300	300	250	350	5	4	45	18.5	14	
FF 300	300	250	350	5	4	45	18.5	14	
FF 300	300	250	350	5	4	45	18.5	14	
FF 300	300	250	350	5	4	45	18.5	14	
FF 300	300	250	350	5	4	45	18.5	14	
FF 300	300	250	350	5	4	45	18.5	14	
FF 300	300	250	350	5	4	45	18.5	14	
FF 300	300	250	350	5	4	45	18.5	14	
FF 300	300	250	350	5	4	45	18.5	14	
FF 300	300	250	350	5	4	45	18.5	14	
FF 350	350	300	400	5	4	45	18.5	15	
FF 400	400	350	450	5	8	22.5	18.5	16	
FF 400	400	350	450	5	8	22.5	18.5	16	
FF 400	400	350	450	5	8	22.5	18	16	
FF 500	500	450	550	5	8	22.5	18	18	
FF 500	500	450	550	5	8	22.5	18.5	18	
FF 500	500	450	550	5	8	22.5	18.5	18	
FF 600	600	550	660	6	8	22.5	24	25	
FF 600	600	550	660	6	8	22.5	24	25	
FF 600	600	550	660	6	8	22.5	24	25	
FF 600	600	550	660	6	8	22.5	24	25	
FF 740	740	680	800	6	8	22.5	24	25	
FF 740	740	680	800	6	8	22.5	24	25	
FF 740	740	680	800	6	8	22.5	24	25	
FF 740	740	680	800	6	8	22.5	24	25	
FF 940	940	880	1000	6	8	22.5	28	28	
FF 940	940	880	1000	6	8	22.5	28	28	
FF 1080	1080	1000	1150	6	8	22.5	28	30	

Type	Main dimensions									
	AC*	LB	HJ	LJ	J	I	II	AD	AD1	
FLSES 80 L	170	212	148	7	136	68	68	-	-	
FLSES 80 LG	185	265	158	9	136	68	68	-	-	
FLSES 90 L	185	261	158	8.5	136	68	68	135	40	
FLSES 90 LU	185	288	158	46	136	68	68	135	40	
FLSES 90 SL	185	261	158	28.6	136	68	68	135	40	
FLSES 90 S	185	261	158	46	136	68	68	135	40	
FLSES 100 L	204	300	158	46	136	68	68	270	40	
FLSES 100 LG	230	309	164	10.5	136	68	68	-	-	
FLSES 100 LR	204	300	158	8	136	68	68	-	-	
FLSES 100 LK	226	319	176.5	52	120	60	60	-	-	
FLSES 112 M	233	309	182	18.5	136	68	68	148	40	
FLSES 112 MG	233	309	182	18.5	136	68	68	148	40	
FLSES 112 MU	233	305	182	18.5	136	68	68	148	40	
FLSES 132 M	262	385	215	23	136	68	68	165	37.5	
FLSES 132 MR	262	447	215	23	136	68	68	165	37.5	
FLSES 132 MU	262	447	215	23	136	68	68	165	37.5	
FLSES 132 SM	262	385	202	23.5	136	68	68	165	37.5	
FLSES 132 S	262	385	215	23	136	68	68	165	37.5	
FLSES 160 L	312	495	280	30	246	126	147	-	-	
FLSES 160 LU	312	510	280	30	246	126	147	-	-	
FLSES 160 LUR	350	510	280	30	246	126	147	-	-	
FLSES 160 MU	350	510	280	30	246	126	147	-	-	
FLSES 160 M	312	495	280	30	246	126	147	-	-	
FLSES 180 L	350	552	301	42	246	126	147	-	-	
FLSES 180 LUR	350	552	301	42	246	126	147	-	-	
FLSES 180 M	350	552	301	42	246	126	147	-	-	
FLSES 180 MT	350	537	299	36	246	126	147	200	45	
FLSES 180 MUR	350	545	280	30	246	126	147	-	-	
FLSES 180 MR	312	510	280	30	246	126	147	-	-	
FLSES 200 LU	410	672	330	49	246	126	147	230	45	
FLSES 225 M/S	540	779	439	69.5	352	173	210	-	-	
FLSES 225 MR	410	678.5	330	55.5	246	126	147	230	45	
FLSES 225 SR	410	678.5	330	55.5	246	126	147	230	45	
FLSES 225 SG	394	733	370	9	352	173	210	-	-	
FLSES 250 MR	540	779	439	69.5	352	173	210	-	-	
FLSES 280 M	540	959	439	69.5	352	173	210	-	-	
FLSES 280 S	540	959	439	69.5	352	173	210	-	-	
FLSES 315 LA	600	1177	525	101	452	219	269	343	45	
FLSES 315 LB	600	1177	525	101	452	219	269	343	45	
FLSES 315 M	600	1177	525	101	452	219	269	343	45	
FLSES 315 S	600	1177	525	101	452	219	269	343	45	
FLSES 355 LA	688	1303	567	121	452	219	269	-	-	
FLSES 355 LAL	688	1303	567	121	452	219	269	-	-	
FLSES 355 LB	688	1303	567	121	452	219	269	-	-	
FLSES 355 LC/LD	688	1303	567	121	452	219	269	-	-	
FLSES/FLS 355 LK	787	1702	762	52	700	224	396	-	-	
FLS 400 L/LV	787	1702	762	52	700	224	396	-	-	
FLS 400 LK	877	1740	810	68	700	224	396	-	-	
FLS 450 L/LV	877	1740	810	68	700	224	396	-	-	

* AC: housing diameter without lifting rings

IMfinity® 3-phase induction motors - High efficiency & Premium efficiency

IP55 Cast Iron frame

Dimensions

Foot and face mounted IM 2101 (IM B34)

Dimensions in millimetres

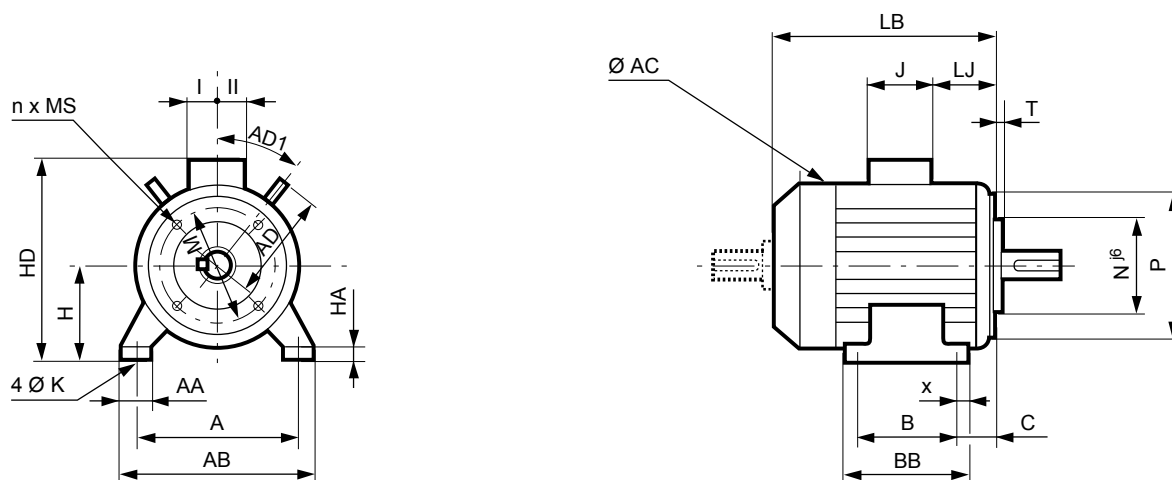

Type	Main dimensions																			Symbol
	A	AB	B	BB	C	X	AA	K	HA	H	AC*	HD	LB	LJ	J	I	II	AD	AD1	
FLSES 80 L	125	157	100	130	50	13	32	10	10	80	170	228	212	7	136	68	68	-	-	FT 100
FLSES 80 LG	125	157	100	130	52	13	32	10	10	80	185	238	245	9	136	68	68	-	-	FT 100
FLSES 90 L	140	170	125	162	56	27.5	26	10	10	90	185	248	239	8.5	136	68	68	135	40	FT 115
FLSES 90 LU	140	170	125	162	56	27.5	26	10	10	90	185	248	266	8.5	136	68	68	135	40	FT 115
FLSES 90 SL	140	170	125	162	56	29	26	9	10	90	185	248	239	8.5	136	68	68	135	40	FT 115
FLSES 90 S	140	170	100	162	56	27.5	26	10	10	90	185	248	239	8.5	136	68	68	135	40	FT 115
FLSES 100 L	160	196	140	185	63	29	40	12	13	100	204	258	300	8	136	68	68	270	40	FT 130
FLSES 100 LG	160	196	140	170	63	11	49	12	13	100	230	264	309	10.5	136	68	68	-	-	FT 130
FLSES 100 LR	160	196	140	185	63	29	40	12	13	100	204	258	300	8	136	68	68	270	40	FT 130
FLSES 100 LK	160	200	140	174	63	22	42	12	12	100	226	276.5	319	52	120	60	60	-	-	FT 130
FLSES 112 M	190	230	140	174	70	32	48	12	12	112	233	294	309	18.5	136	68	68	148	40	FT 130
FLSES 112 MG	190	230	140	174	70	32	48	12	12	112	233	294	309	18.5	136	68	68	148	40	FT 130
FLSES 112 MU	190	230	140	174	70	32	48	12	12	112	233	294	305	18.5	136	68	68	148	40	FT 130
FLSES 132 M	216	255	178	240	89	48	63	12	16	132	262	347	385	23	136	68	68	165	37.5	FT 215
FLSES 132 MR	216	255	178	240	89	48	63	12	16	132	262	347	447	23	136	68	68	165	37.5	FT 215
FLSES 132 MU	216	255	178	240	89	48	63	12	16	132	262	347	447	23	136	68	68	165	37.5	FT 215
FLSES 132 SM	216	255	178	240	89	48	63	12	16	132	262	334	385	23	136	68	68	165	37.5	FT 215
FLSES 132 S	216	255	140	240	89	48	63	12	16	132	262	347	385	23	136	68	68	165	37.5	FT 215

* AC: housing diameter without lifting rings

IMfinity® 3-phase induction motors - High efficiency & Premium efficiency

IP55 Cast Iron frame

Dimensions

Face mounted IM 3601 (IM B14)

Dimensions in millimetres

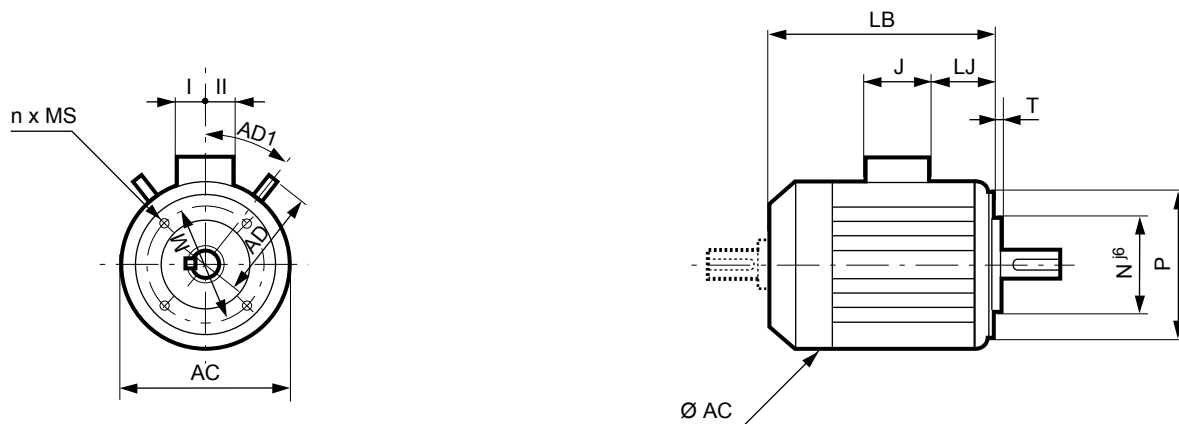

IP55 CAST IRON MOTORS

IEC symbol	Faceplate dimensions					
	M	N	P	T	n	MS
FT 100	100	80	120	3	4	M6
FT 100	100	80	120	3	4	M6
FT 115	115	95	140	3	4	M8
FT 115	115	95	140	3	4	M8
FT 115	115	95	140	3	4	M8
FT 115	115	95	140	3	4	M8
FT 130	130	110	160	3.5	4	M8
FT 130	130	110	160	3.5	4	M8
FT 130	130	110	160	3.5	4	M8
FT 130	130	110	160	3.5	4	M8
FT 130	130	110	160	3.5	4	M8
FT 130	130	110	160	3.5	4	M8
FT 130	130	110	160	3.5	4	M8
FT 215	215	180	250	4	4	M12
FT 215	215	180	250	4	4	M12
FT 215	215	180	250	4	4	M12
FT 215	215	180	250	4	4	M12
FT 215	215	180	250	4	4	M12

Type	Main dimensions							
	AC*	LB	LJ	J	I	II	AD	AD1
FLSES 80 L	170	212	7	136	68	68	-	-
FLSES 80 LG	185	245	9	136	68	68	-	-
FLSES 90 L	185	239	8.5	136	68	68	135	40
FLSES 90 LU	185	266	8.5	136	68	68	135	40
FLSES 90 SL	185	241	8.6	136	68	68	135	40
FLSES 90 S	185	239	8.5	136	68	68	135	40
FLSES 100 L	204	300	8	136	68	68	270	40
FLSES 100 LG	235	309	10.5	136	68	68	-	-
FLSES 100 LR	204	300	8	136	68	68	-	-
FLSES 100 LK	226	319	52	120	60	60	-	-
FLSES 112 M	233	309	18.5	136	68	68	148	40
FLSES 112 MG	233	309	18.5	136	68	68	148	40
FLSES 112 MU	233	305	18.5	136	68	68	148	40
FLSES 132 M	262	385	23	136	68	68	165	37.5
FLSES 132 MR	262	447	23	136	68	68	165	37.5
FLSES 132 MU	262	447	23	136	68	68	165	37.5
FLSES 132 SM	262	385	23.5	136	68	68	165	37.5
FLSES 132 S	262	385	23	136	68	68	165	37.5

* AC: housing diameter without lifting rings

IMfinity® 3-phase induction motors - High efficiency & Premium efficiency

IP55 Cast Iron frame

Construction

Bearings and lubrication

PERMANENTLY GREASED BEARINGS

Under normal operating conditions, the service life in hours of the lubricant is indicated in the table below for ambient temperatures less than 55°C.

Series	Type	No. of poles	Types of permanently greased bearing		Grease life according to speed of rotation								
					3000 min ⁻¹			1500 min ⁻¹			1000 min ⁻¹		
					25°C	40°C	55°C	25°C	40°C	55°C	25°C	40°C	55°C
FLSES	80 L	2	6203 CN	6204 C3	≥40000	≥40000	25000	-	-	-	-	-	-
	80 LG	4	6204 C3	6205 C3	-	-	-	≥40000	≥40000	31000	-	-	-
	90 SL/L	2; 4; 6			≥40000	≥40000	24000	-	-	-	≥40000	≥40000	34000
	90 LU	2; 6	6205 C3	6205 C3	≥40000	≥40000	24000	-	-	-	≥40000	≥40000	34000
	100 L	2; 4	6205 C3	6206 C3	≥40000	≥40000	22000	≥40000	≥40000	30000	-	-	-
	100 LG	4; 6			-	-	-	-	-	≥40000	≥40000	33000	
	112 MG	2; 6			≥40000	≥40000	22000	-	-	-	-	-	-
	112 MU	4	6206 C3	6206 C3	-	-	-	≥40000	≥40000	30000	-	-	-
	132 SM/M	2; 4; 6	6207 C3	6308 C3	≥40000	≥40000	19000	≥40000	≥40000	25000	≥40000	≥40000	30000
	132 MU	2; 4	6307 C3	6308 C3	≥40000	≥40000	19000	≥40000	≥40000	25000	-	-	-
	132 MR	4; 6	6308 C3	6308 C3	-	-	-	≥40000	≥40000	25000	≥40000	≥40000	30000
	160 M	2; 4; 6	6210 C3	6309 C3	≥40000	37800	18900	≥40000	≥40000	36900	≥40000	≥40000	20050
	160 MU	6			-	-	-	-	-	-	-	-	
	160 LUR	2; 4; 6	6210 C3	6310 C3	≥40000	24500	12250	≥40000	36400	18200	≥40000	≥40000	22450
	180 M	2	6212 C3	6310 C3	34000	17000	8500	-	-	-	-	-	-
	180 MT	4	6210 C3	6310 C3	-	-	-	≥40000	35500	17750	-	-	-
	180 MUR	2	6312 C3	6310 C3	≥40000	22800	11400	-	-	-	-	-	-
	180 L	4; 6	6212 C3	6310 C3	-	-	-	≥40000	39500	19750	≥40000	≥40000	29050
	180 LUR	4; 6	6312 C3	6310 C3	-	-	-	≥40000	≥40000	22900	≥40000	≥40000	29900
	200 LU	2; 4; 6	6312 C3	6312 C3	28600	14300	7150	≥40000	25400	12700	≥40000	33200	16600
225 S	4	6314 C3	6314 C3	-	-	-	≥40000	23700	11850	-	-	-	
225 SR	4	6312 C3	6313 C3	-	-	-	≥40000	≥40000	21500	-	-	-	
225 M	4; 6	6314 C3	6314 C3	-	-	-	≥40000	23700	11850	≥40000	25600	12800	
225 MR	2	6312 C3	6313 C3	≥40000	22800	11400	-	-	-	-	-	-	

Note: On request, all motors can be fitted with grease nipples.

IMfinity® 3-phase induction motors - High efficiency & Premium efficiency

IP55 Cast Iron frame

Construction

Bearings and lubrication

BEARINGS WITH GREASE NIPPLES

The chart opposite shows the greasing intervals, depending on the type of motor, for standard bearing assemblies of frame size ≥ 160 mm fitted with grease nipples, operating at an ambient temperature of 25°C, 40°C and 55°C on a horizontal shaft machine.

The chart below is valid for FLSES/FLS motors lubricated with Polyrex EM103 grease, which is used as standard.

SPECIAL CONSTRUCTION AND ENVIRONMENT

For vertical shaft machines, the greasing intervals will be approximately 80% of the values stated in the table below.

Note: The quality and quantity of grease and the greasing interval are shown on the machine nameplate.

For special assemblies (motors fitted with DE roller bearings or other types), machines of frame size ≥ 160 mm have bearings with grease nipples.

Instructions for bearing maintenance are given on the nameplates on these machines.

Series	Type	No. of poles	Type of bearing for bearings with grease nipples		Quantity of grease g	Greasing intervals in hours								
			N.D.E.	D.E.		3000 min ⁻¹			1500 min ⁻¹			1000 min ⁻¹		
						25°C	40°C	55°C	25°C	40°C	55°C	25°C	40°C	55°C
FLSES	160 M*	2; 4; 6	6210 C3	6309 C3	13	22200	11100	5550	32400	16200	8100	39800	19900	9950
	160 MU	6				-	-	-	-	-	-	23400	11700	5850
	160 LUR*	2; 4; 6	6210 C3	6310 C3	15	19600	9800	4900	30400	15200	7600	38200	19100	6600
	180 M*	2	6212 C3	6310 C3	15	18000	9000	4500	-	-	-	-	-	-
	180 MT*	4	6210 C3	6310 C3	15	-	-	-	30400	15200	7600	-	-	-
	180 MUR*	2	6312 C3	6310 C3	15	10600	5300	2650	-	-	-	-	-	-
	180 L*	4; 6	6212 C3	6310 C3	20	-	-	-	29200	14600	7300	37200	18600	9300
	180 LUR*	4; 6	6312 C3	6310 C3	20	-	-	-	26800	13400	6700	35000	17500	8750
	200 LU*	2; 4; 6	6312 C3	6312 C3	20	15200	7600	3800	26800	13400	6700	35000	17500	8750
	225 S*	4	6314 C3	6314 C3	25	-	-	-	23600	11800	5900	-	-	-
	225 SR*	4	6312 C3	6313 C3	25	-	-	-	25200	12600	6300	-	-	-
	225 M*	4; 6	6314 C3	6314 C3	25	-	-	-	23600	11800	5900	32200	16100	8050
	225 MR*	2	6312 C3	6313 C3	25	13400	6700	3350	-	-	-	-	-	-
	250 M	2; 6	6314 C3	6314 C3	25	10400	5200	2600	-	-	-	32200	16100	8050
	250 MR	4				-	-	-	17800	8900	4450	-	-	-
	280 S/M	2; 4; 6	6314 C3	6316 C3	35	7200	3600	1800	21000	13230	6615	29000	29000	18270
	315 S/M/L	2	6316 C3	6218 C3	35	7400	5880	2920	-	-	-	-	-	-
	315 S/M/L	4; 6	6316 C3	6320 C3	50	-	-	-	15600	12400	6160	25000	25000	12500
355 L	2	6316 C3	6218 C3	35	7400	3700	1850	-	-	-	-	-	-	
355 L	4; 6	6316 C3	6322 C3	60	-	-	-	13200	8316	4160	22000	13860	6930	
FLSES/FLS	355 LK	4; 6	6324 C3	6324 C3	72	-	-	-	7500	3700	2800	20000	20000	10000
FLS	400 L/LV	4; 6	6324 C3	6324 C3	72	-	-	-	7500	3700	2800	20000	20000	10000
	400 LK/450 L	4; 6	6328 C3	6328 C3	93	-	-	-	4600	2300	1100	10000	6000	3000

* bearing with grease nipples on request

STANDARD BEARING FITTING ARRANGEMENTS

FLSES series		Horizontal shaft	Vertical shaft	
Mounting arrangement			Shaft facing down	Shaft facing up
Foot mounted motors	Mounting arrangement	B3	V5	V6
	standard mounting	The DE bearing is: - located at DE for frame ≤ 132 - locked for frame ≥ 160	The DE bearing is locked	The DE bearing is: - located at DE for frame ≤ 90 - locked for frame ≥ 100
	on request	DE bearing locked for frame < 132		DE bearing locked for frame < 90
Flange mounted motors (or foot and flange)	Mounting arrangement	B5/B35/B14/B34	V1/V15/V18/V58	V3/V36/V19/V69
	standard mounting	The DE bearing is locked on frames 80 to 355LD The NDE bearing is locked on frames 355LK to 450	The DE bearing is locked on frames 80 to 355LD The NDE bearing is locked on frames 355LK to 450	The DE bearing is locked on frames 80 to 355LD The NDE bearing is locked on frames 355LK to 450

IMfinity® 3-phase induction motors - High efficiency & Premium efficiency

IP55 Cast Iron frame

Construction

Axial loads

HORIZONTAL MOTOR

For a bearing life L_{10h} of 25.000 hours and 40.000 hours

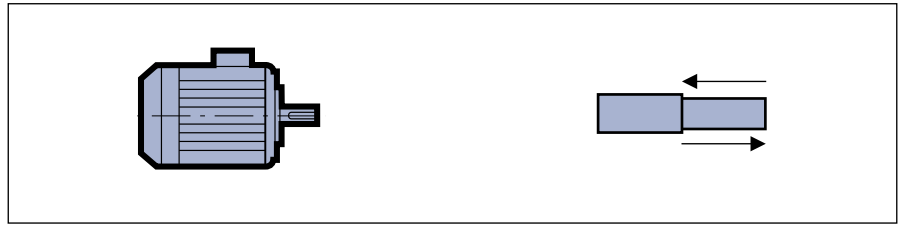

Series	Type	No. of poles	Permissible axial load (in daN) on main shaft extension for standard bearing assembly											
			3000 min ⁻¹				1500 min ⁻¹				1000 min ⁻¹			
			25 000 hours	40 000 hours	25 000 hours	40 000 hours	25 000 hours	40 000 hours	25 000 hours	40 000 hours	25 000 hours	40 000 hours	25 000 hours	40 000 hours
IM B3/B6 IM B7/B8 IM B5/B35 IM B14/B34														
FLSES	80 L	2	30	21	60	51	-	-	-	-	-	-	-	-
	80 LG	2; 4	28	19	68	59	48	34	88	74	-	-	-	-
	90 SL/L	2; 4; 6	29	23	69	56	45	32	85	72	56	40	96	80
	90 LU	2; 4; 6	22	13	72	63	38	25	88	75	47	32	97	82
	100 L	2; 4	40	26	90	76	61	43	111	93	-	-	-	-
	100 LR	4	-	-	-	-	61	43	111	93	-	-	-	-
	100 LG	4; 6	-	-	-	-	55	38	105	88	75	53	125	103
	112 MG	2; 6	37	24	87	74	-	-	-	-	82	61	132	111
	112 MU	4; 6	-	-	-	-	54	36	114	96	66	45	126	105
	132 SM/M	2; 4; 6	101	74	171	144	146	109	216	179	182	138	252	208
	132 MU	6	-	-	-	-	-	-	-	-	169	126	249	206
	132 MR	4	-	-	-	-	129	93	219	183	-	-	-	-
	160 M	2; 4	129	94	229	194	187	140	287	240	234	177	334	277
	160 MU	6	-	-	-	-	-	-	-	-	219	164	319	264
	160 L	2; 4	118	83	218	183	195	148	295	248	-	-	-	-
	160 LUR	2; 4; 6	158	117	258	217	212	158	312	258	257	193	357	293
	180 M	2; 4	189	148	237	196	228	174	291	237	-	-	-	-
	180 MT	4	-	-	-	-	215	161	315	261	-	-	-	-
	180 MUR	2	178	137	241	200	-	-	-	-	-	-	-	-
	180 L	4; 6	-	-	-	-	240	186	288	234	272	208	320	256
	180 LUR	4; 6	-	-	-	-	224	170	287	233	224	162	287	225
	200 LU	2; 4; 6	249	196	312	259	316	245	379	308	327	245	390	308
	225 S	4	-	-	-	-	427	336	490	399	-	-	-	-
	225 SR	4	-	-	-	-	370	290	433	353	-	-	-	-
	225 M	4; 6	-	-	-	-	416	325	496	405	511	402	591	482
	225 MR	2	280	220	343	283	-	-	-	-	-	-	-	-
	250 M	2; 6	308	240	388	320	-	-	-	-	506	400	506	400
	250 MR	4	-	-	-	-	413	322	493	402	-	-	-	-
	280 S/M	2; 4; 6	342	258	484	400	483	372	625	514	581	445	723	587
	315 S/M/LA/LB	2; 6	411	348	165	102	-	-	-	-	933	761	687	515
	315 S/M/LA/LB	4	-	-	-	-	814	670	568	424	-	-	-	-
	355 LA/LB/LC	2	393	333	147	87	-	-	-	-	-	-	-	-
	355 LAL	4	-	-	-	-	876	724	630	478	-	-	-	-
355 LA/LB/LC	4; 6	-	-	-	-	876	724	630	478	947	764	701	518	
355 LKA	6	-	-	-	-	-	-	-	-	937	760	615	440	
355 LKB	6	-	-	-	-	-	-	-	-	897	725	577	405	
FLS	400 LA	4; 6	-	-	-	-	873	-	593	-	941	-	661	-
	400 LB/LVB	4; 6	-	-	-	-	862	-	582	-	923	-	943	-
	400 LKB	6	-	-	-	-	-	-	-	-	1162	-	941	-
	450 LA/LVA	4; 6	-	-	-	-	1061	-	707	-	1179	-	808	-
	450 LB/LKB	4; 6	-	-	-	-	1041	-	687	-	1162	-	941	-

IP55 CAST IRON MOTORS

IMfinity® 3-phase induction motors - High efficiency & Premium efficiency

IP55 Cast Iron frame

Construction

Axial loads

VERTICAL MOTOR SHAFT FACING DOWN

For a bearing life L_{10h} of 25.000 hours and 40.000 hours

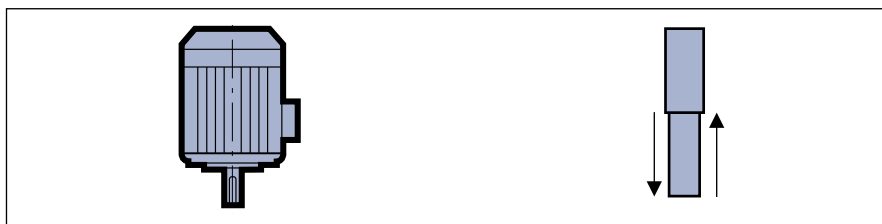

Series	Type	No. of poles	Permissible axial load (in daN) on main shaft extension for standard bearing assembly											
			3000 min ⁻¹				1500 min ⁻¹				1000 min ⁻¹			
			25 000 hours	40 000 hours	25 000 hours	40 000 hours	25 000 hours	40 000 hours	25 000 hours	40 000 hours	25 000 hours	40 000 hours	25 000 hours	40 000 hours
IM V5 IM V1/V15 IM V18/V58														
FLSES	80 L	2	29	20	63	54	-	-	-	-	-	-	-	-
	80 LG	2; 4	26	16	72	62	45	32	93	78	-	-	-	-
	90 SL/L	2; 4; 6	26	16	73	63	42	28	91	78	53	37	101	86
	90 LU	2; 4; 6	19	9	77	67	33	20	95	82	43	28	105	89
	100 L	2; 4	36	23	96	83	56	38	119	101	-	-	-	-
	100 LR	4	-	-	-	-	55	37	120	102	-	-	-	-
	100 LG	4; 6	-	-	-	-	48	31	116	99	68	46	137	115
	112 MG	2; 6	31	18	98	85	-	-	-	-	75	53	145	123
	112 MU	4; 6	-	-	-	-	45	28	128	110	57	36	140	119
	132 SM/M	2; 4; 6	90	62	189	161	135	98	235	198	171	127	271	227
	132 MU	6	-	-	-	-	-	-	-	-	154	110	275	231
	132 MR	4	-	-	-	-	113	77	245	208	-	-	-	-
	160 M	2; 4; 6	107	72	264	229	164	117	325	277	209	152	374	317
	160 MU	6	-	-	-	-	-	-	-	-	189	133	375	319
	160 L	2; 4	94	59	256	221	174	126	331	284	-	-	-	-
	160 LUR	2; 4; 6	133	92	297	256	185	130	362	308	227	162	417	352
	180 M	2; 4	160	119	279	238	187	132	361	306	-	-	-	-
	180 MT	4	-	-	-	-	190	135	361	306	-	-	-	-
	180 MUR	2	144	102	294	252	-	-	-	-	-	-	-	-
	180 L	4; 6	-	-	-	-	206	151	346	291	233	169	391	326
	180 LUR	4; 6	-	-	-	-	187	132	355	300	183	120	377	314
	200 LU	2; 4; 6	207	153	375	320	262	190	471	398	269	186	505	422
	225 S	4	-	-	-	-	351	260	611	520	-	-	-	-
	225 SR	4	-	-	-	-	317	236	520	438	-	-	-	-
	225 M	4; 6	-	-	-	-	333	241	627	535	428	319	723	613
	225 MR	2	234	174	413	352	-	-	-	-	-	-	-	-
	250 M	2; 6	247	179	481	413	-	-	-	-	423	315	647	539
	250 MR	4	-	-	-	-	315	223	639	547	-	-	-	-
	280 S/M	2; 4; 6	396	307	484	395	507	394	670	557	602	461	793	651
	315 S/M/LA/LB	2; 6	226	156	417	347	-	-	-	-	-	-	-	-
	315 S/M/LA/LB	4	-	-	-	-	601	449	893	741	683	515	1042	873
	355 LA/LB/LC	2	135	65	524	454	-	-	-	-	-	-	-	-
355 LAL	4	-	-	-	-	516	350	1123	957	-	-	-	-	
355 LA/LB/LC	4; 6	-	-	-	-	516	350	1123	957	566	364	1328	1126	
355 LKA	6	-	-	-	-	-	-	-	-	650	442	1349	1140	
355 LKB	6	-	-	-	-	-	-	-	-	393	185	1624	1416	
FLS	400 LA	4; 6	-	-	-	-	672	-	1058	-	649	-	1315	-
	400 LB/LVB	4; 6	-	-	-	-	612	-	1106	-	571	-	1372	-
	400 LKB	6	-	-	-	-	-	-	-	-	671	-	1772	-
	450 LA/LVA	4; 6	-	-	-	-	868	-	1247	-	791	-	1668	-
	450 LB/LKB	4; 6	-	-	-	-	729	-	1366	-	671	-	1772	-

IMfinity® 3-phase induction motors - High efficiency & Premium efficiency

IP55 Cast Iron frame

Construction

Axial loads

VERTICAL MOTOR SHAFT FACING UP

For a bearing life L_{10h}
of 25.000 hours
and 40.000 hours

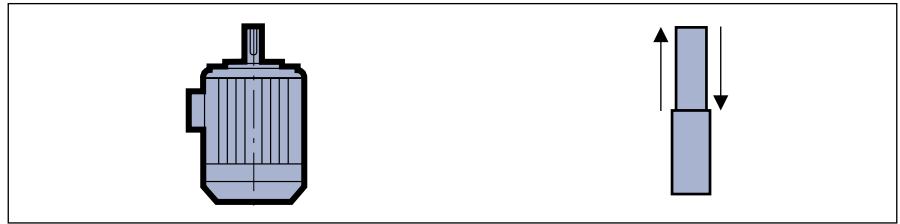

Series	Type	No. of poles	Permissible axial load (in daN) on main shaft extension for standard bearing assembly											
			3000 min ⁻¹				1500 min ⁻¹				1000 min ⁻¹			
			25 000 hours	40 000 hours	25 000 hours	40 000 hours	25 000 hours	40 000 hours	25 000 hours	40 000 hours	25 000 hours	40 000 hours	25 000 hours	40 000 hours
IM V6 IM V3/V36 IM V19/V69														
FLSES	80 L	2	59	50	33	24	-	-	-	-	-	-	-	-
	80 LG	2; 4	66	56	32	22	85	71	53	39	-	-	-	-
	90 SL/L	2; 4; 6	66	56	33	23	82	68	51	38	93	77	61	46
	90 LU	2; 4; 6	69	59	27	18	81	76	43	38	93	82	55	32
	100 L	2	86	72	46	33	106	88	69	51	-	-	-	-
	100 LR	4	-	-	-	-	105	87	70	52	-	-	-	-
	100 LG	4; 6	-	-	-	-	98	81	67	49	118	96	87	66
	112 MG	2; 6	81	68	48	35	-	-	-	-	125	103	95	73
	112 MU	4; 6	-	-	-	-	105	88	68	50	117	96	80	60
	132 SM/M	2; 4; 6	159	132	120	91	205	168	165	128	249	205	179	135
	132 MU	6	-	-	-	-	-	-	-	-	234	190	195	151
	132 MR	4	-	-	-	-	203	167	155	118	-	-	-	-
	160 M	2; 4; 6	207	172	164	129	264	217	225	177	309	252	274	217
	160 MU	6	-	-	-	-	-	-	-	-	289	233	275	219
	160 L	2; 4	194	159	156	121	274	226	231	184	-	-	-	-
	160 LUR	2; 4; 6	233	192	197	156	285	230	262	208	327	262	317	252
	180 M	2; 4	208	167	231	190	250	195	298	243	-	-	-	-
	180 MT	4	-	-	-	-	290	235	261	206	-	-	-	-
	180 MUR	2	207	165	231	189	-	-	-	-	-	-	-	-
	180 L	4; 6	-	-	-	-	254	199	298	243	281	217	343	278
	180 LUR	4; 6	-	-	-	-	250	195	292	237	246	183	314	251
	200 LU	2; 4; 6	270	216	312	257	325	253	408	335	332	249	442	359
	225 S	4	-	-	-	-	414	323	548	457	-	-	-	-
	225 SR	4	-	-	-	-	380	299	457	375	-	-	-	-
	225 M	4; 6	-	-	-	-	413	321	547	455	508	399	643	533
	225 MR	2	297	237	350	289	-	-	-	-	-	-	-	-
	250 M	2; 6	327	259	401	333	-	-	-	-	423	315	647	539
	250 MR	4	-	-	-	-	395	303	559	467	-	-	-	-
	280 S/M	2; 4; 6	396	307	484	395	507	394	670	557	602	461	793	651
	315 S/M/L	2	226	156	417	347	-	-	-	-	-	-	-	-
	315 S/M/L	4; 6	-	-	-	-	601	449	893	741	683	515	1042	873
	355 L	2	135	65	524	454	-	-	-	-	-	-	-	-
355 L	4; 6	-	-	-	-	516	350	1123	957	566	364	1328	1126	

400 and 450: Please consult Leroy-Somer

IMfinity® 3-phase induction motors - High efficiency & Premium efficiency

IP55 Cast Iron frame

Construction

Radial loads

STANDARD FITTING ARRANGEMENT

Permissible radial load on main shaft extension with a bearing life L_{10h} of 25.000 hours.

FR: Radial Force

X: Distance with respect to the shaft shoulder

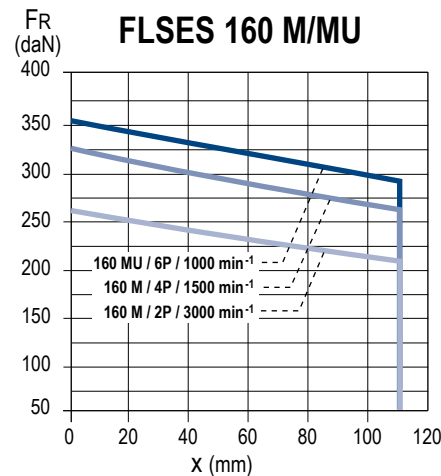
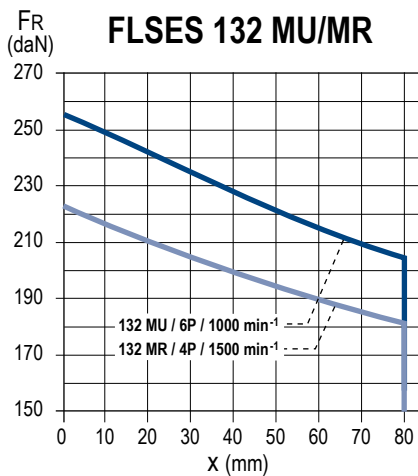
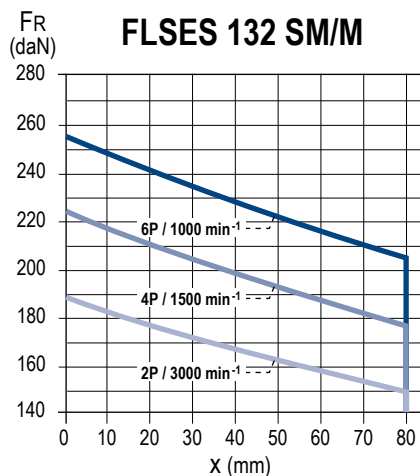
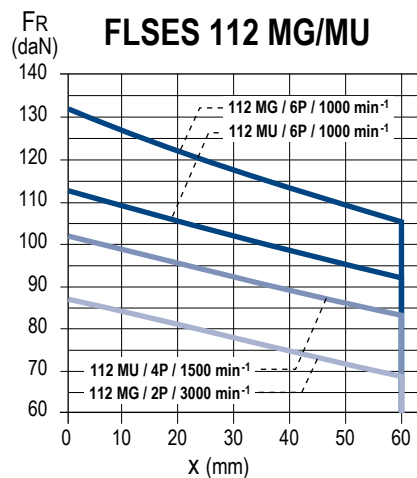
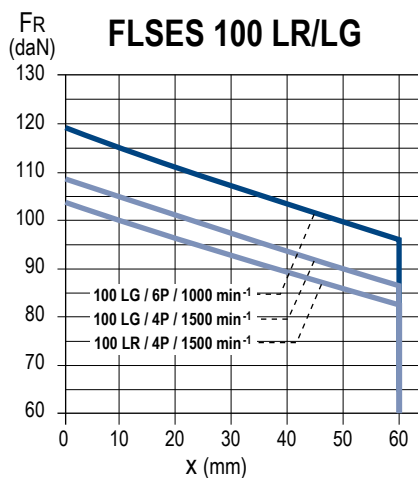
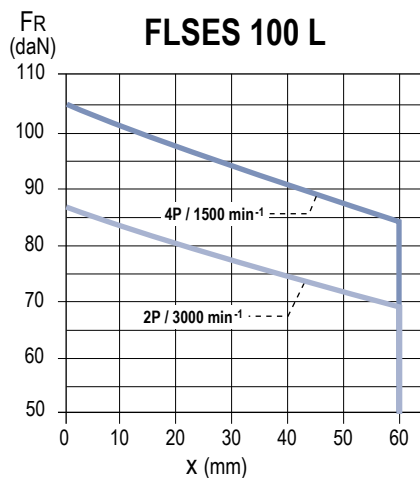
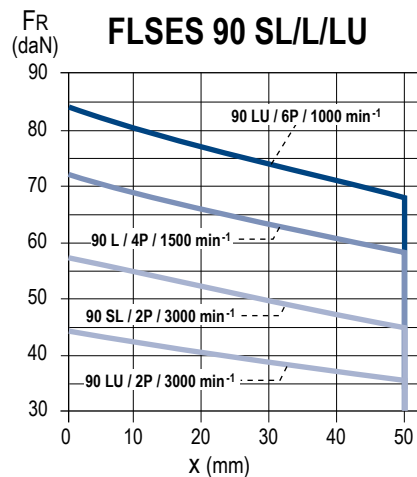
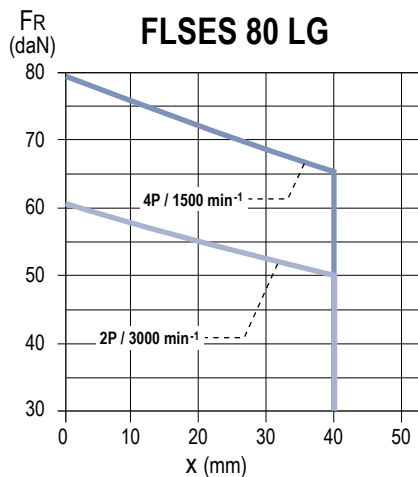
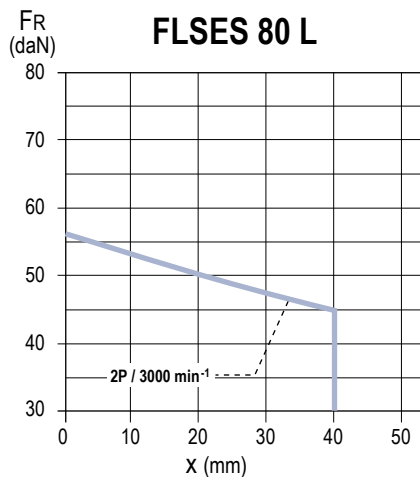

IP55 CAST IRON MOTORS

IMfinity® 3-phase induction motors - High efficiency & Premium efficiency

IP55 Cast Iron frame

Construction

Radial loads

STANDARD FITTING ARRANGEMENT

Permissible radial load on main shaft extension with a bearing life L_{10h} of 25.000 hours.

FR: Radial Force

X: Distance with respect to the shaft shoulder

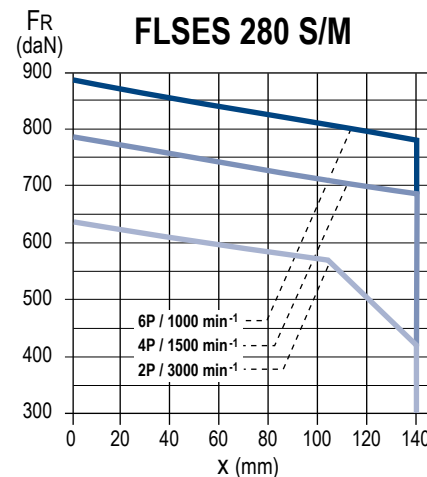
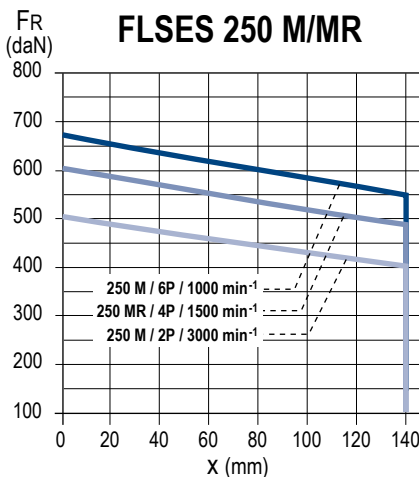
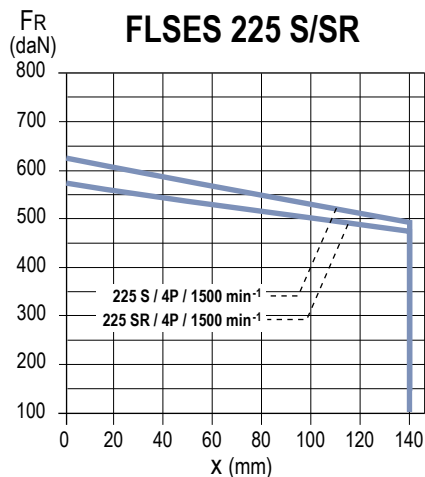
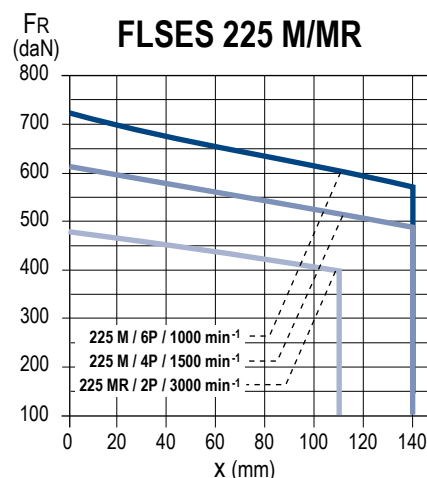
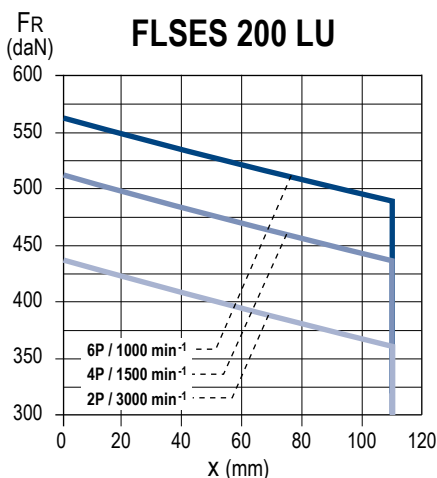
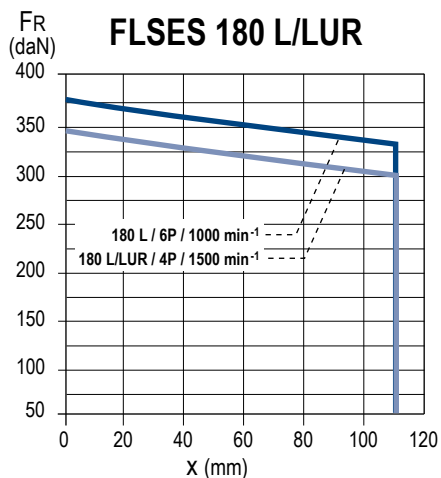
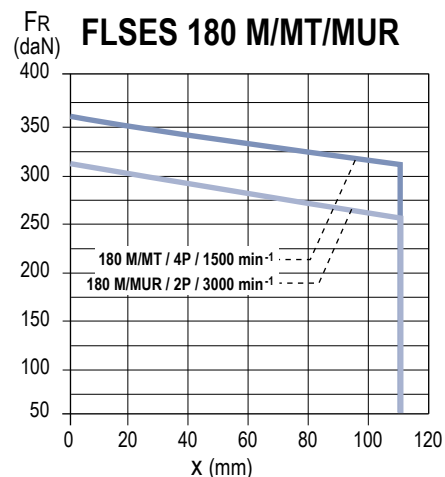
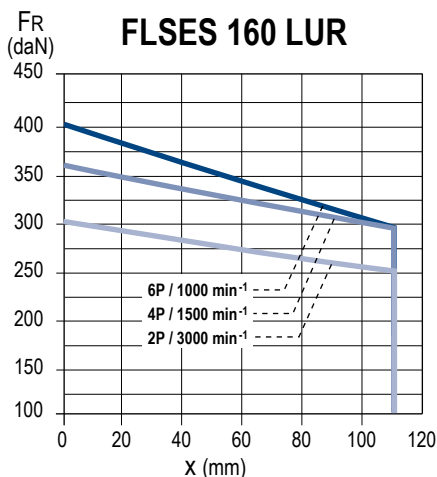
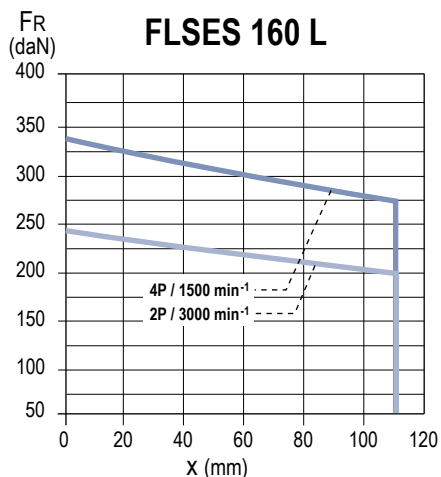

IP55 CAST IRON MOTORS

IMfinity® 3-phase induction motors - High efficiency & Premium efficiency

IP55 Cast Iron frame

Construction

Radial loads

STANDARD FITTING ARRANGEMENT

Permissible radial load on main shaft extension with a bearing life L_{10h} of 25.000 hours.

FR: Radial Force

X: Distance with respect to the shaft shoulder

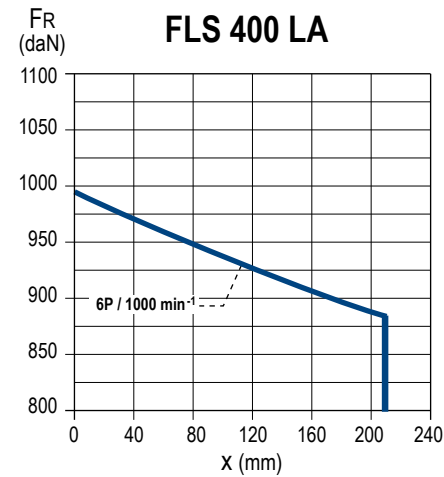
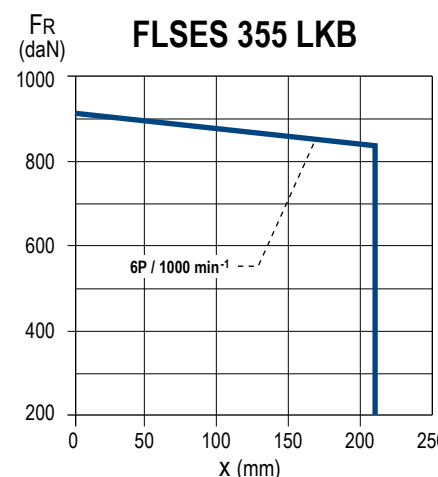
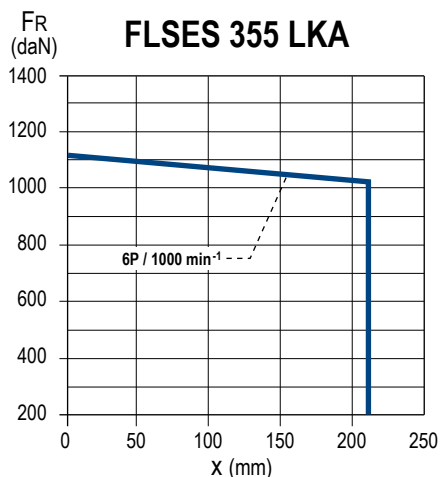
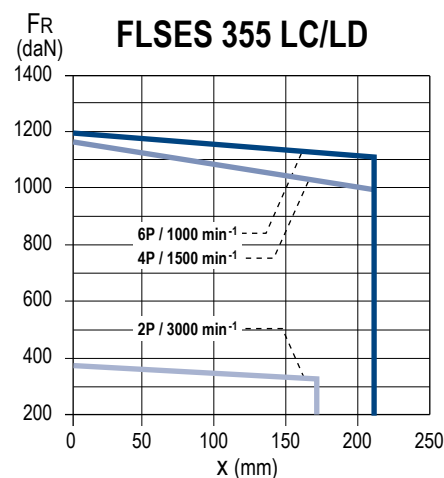
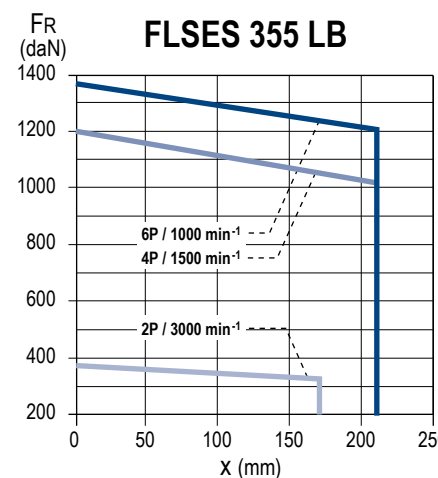
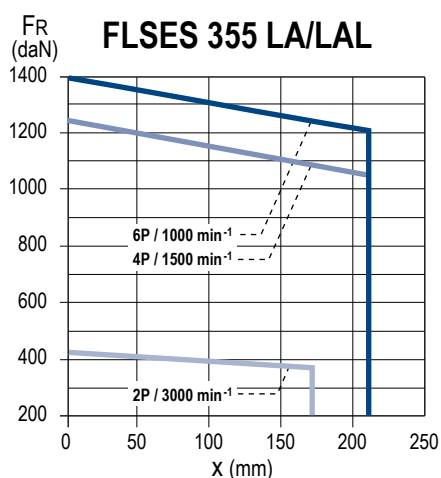
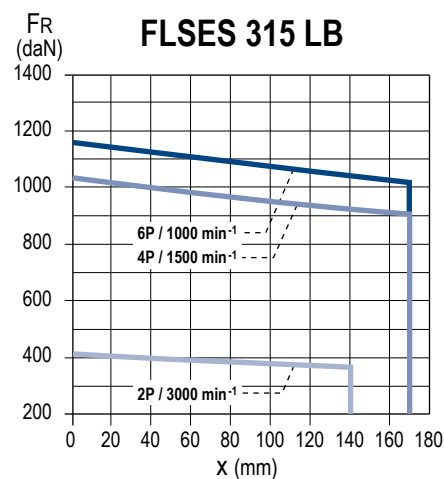
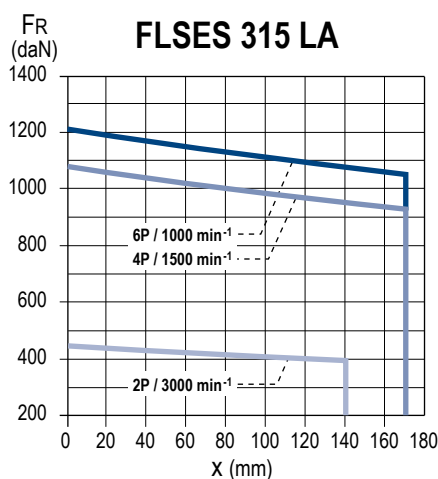
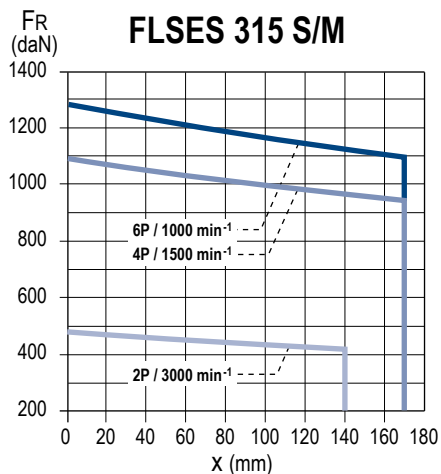

IP55 CAST IRON MOTORS

IMfinity® 3-phase induction motors - High efficiency & Premium efficiency

IP55 Cast Iron frame

Construction

Radial loads

STANDARD FITTING ARRANGEMENT

Permissible radial load on main shaft extension with a bearing life L_{10h} of 25.000 hours.

FR: Radial Force

X: Distance with respect to the shaft shoulder

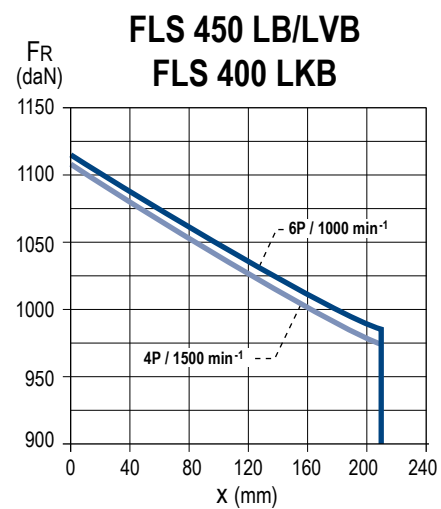
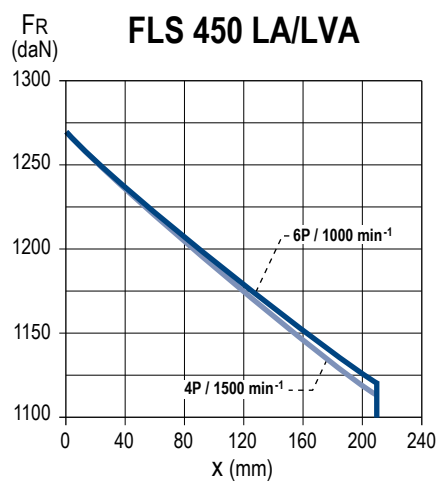
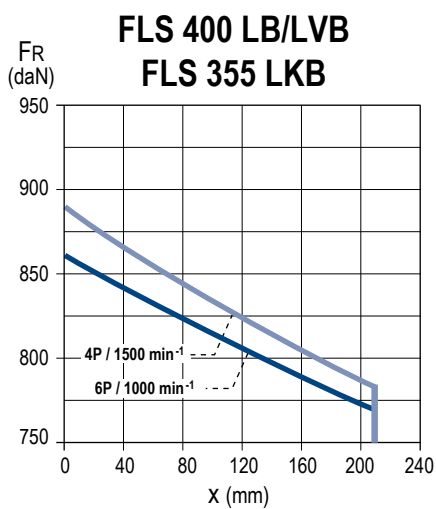

IP55 CAST IRON MOTORS

IMfinity® 3-phase induction motors - High efficiency & Premium efficiency

IP55 Cast Iron frame

Construction

Radial loads

SPECIAL FITTING ARRANGEMENT

Type of drive end roller bearings

Series	Type	No. of poles	Non drive end bearing (N.D.E.)	Drive end bearing (D.E.)
FLSES	160 M/MU	4; 6	6210 C3	NU 309
	160 L	4		
	160 LUR	6	6210 C3	NU 310
	180 MT	4		
	180 M	4	6212 C3	NU 310
	180 L	4; 6		
	180 LUR	4; 6	6312 C3	NU 310
	200 LU	4; 6		
	225 S	4	6314 C3	NU 314
	225 SR	4		
	225 M	4; 6	6314 C3	NU 314
	225 MR	2		
	250 M	6	6314 C3	NU 314
	250 MR	4		
	280 S/M	4; 6	6316 C3	NU 316
315 S/M/L	4; 6			
355 L	4; 6	6316 C3	NU 322	
FLSES/FLS	355 LK			6
FLS	400 LA/LB	4; 6	6324 C3	NU 324
	400 LKA/LKB	4; 6		
	450 LA/LB/LVA/LVB	4; 6	6328 C3	NU 328

IMfinity® 3-phase induction motors - High efficiency & Premium efficiency

IP55 Cast Iron frame

Construction

Radial loads

SPECIAL FITTING ARRANGEMENT

Permissible radial load on main shaft extension with a bearing life L_{10h} of 25.000 hours.

FR: Radial Force

X: Distance with respect to the shaft shoulder

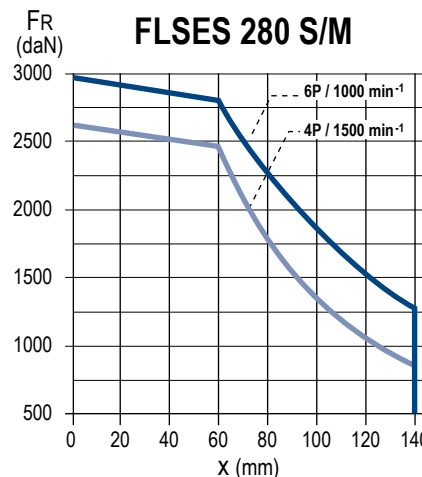
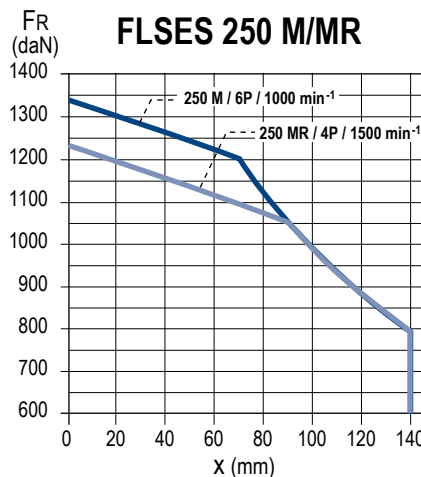
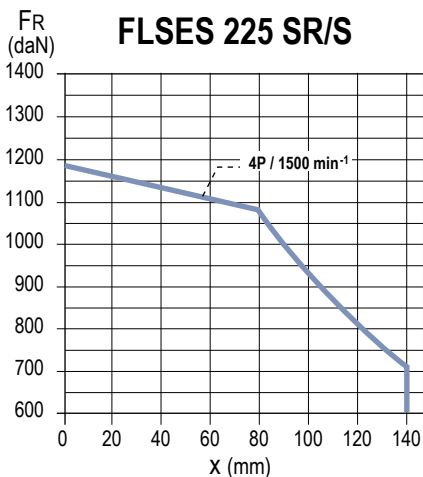
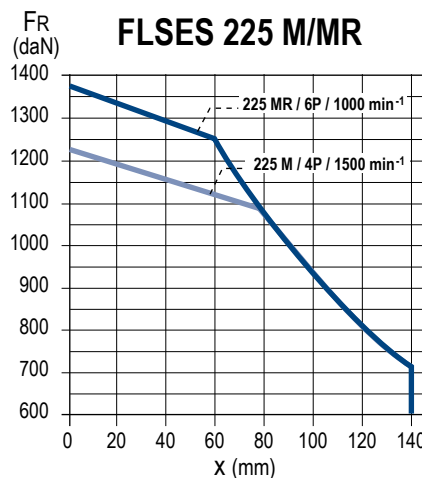
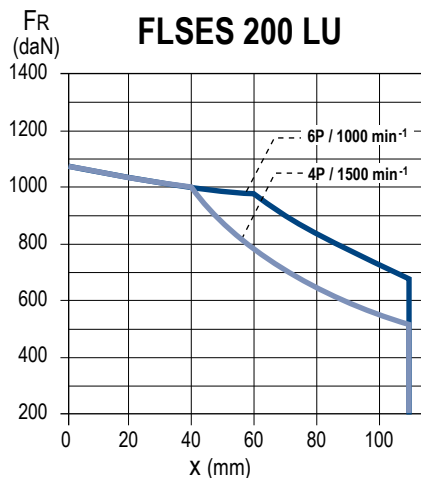
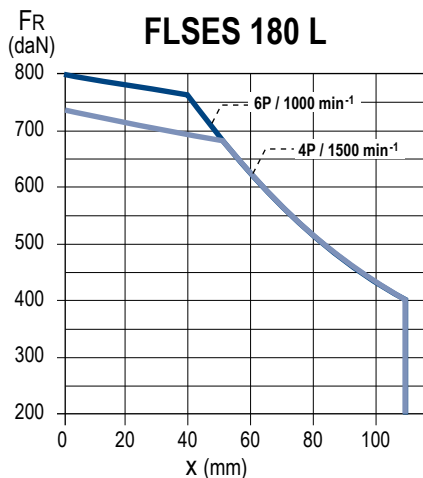
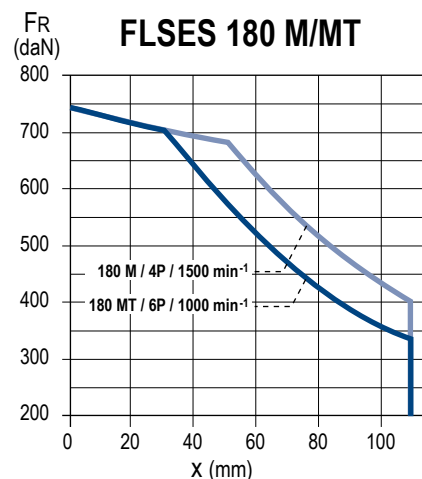
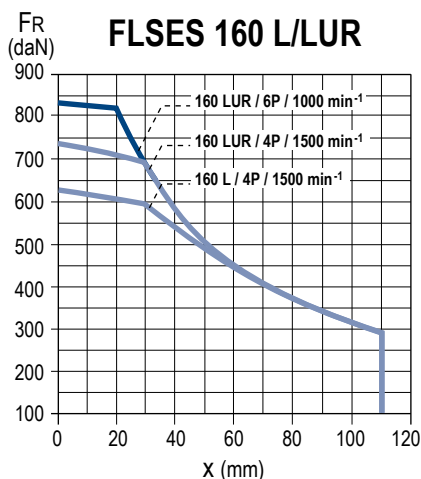
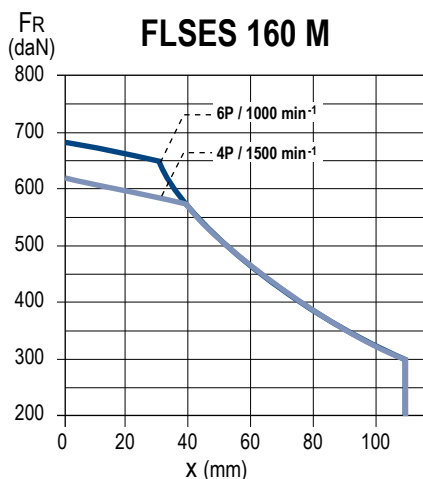

IP55 CAST IRON MOTORS

IMfinity® 3-phase induction motors - High efficiency & Premium efficiency

IP55 Cast Iron frame

Construction

Radial loads

SPECIAL FITTING ARRANGEMENT

Permissible radial load on main shaft extension with a bearing life L_{10h} of 25.000 hours.

FR: Radial Force

X: Distance with respect to the shaft shoulder

IP55 CAST IRON MOTORS

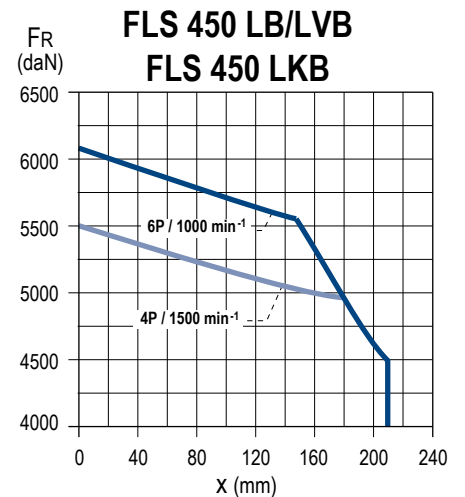
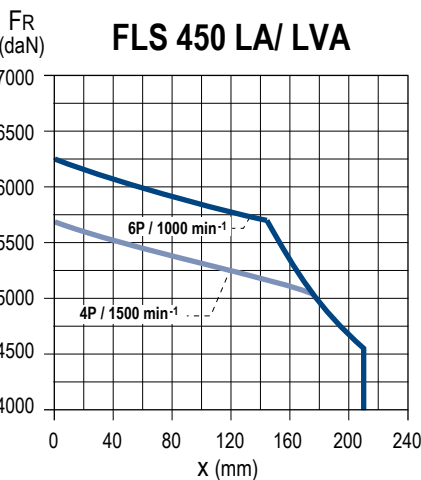
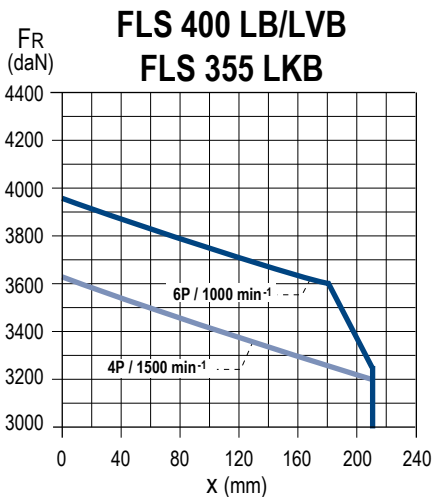
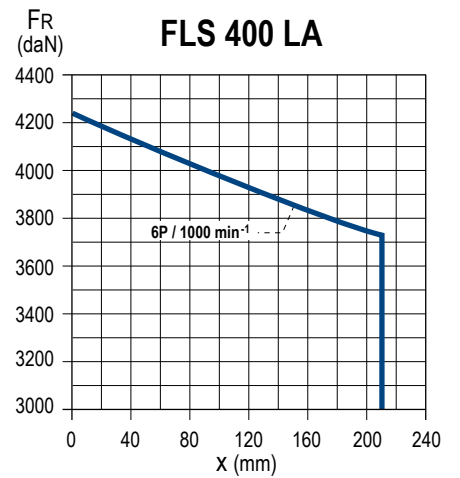
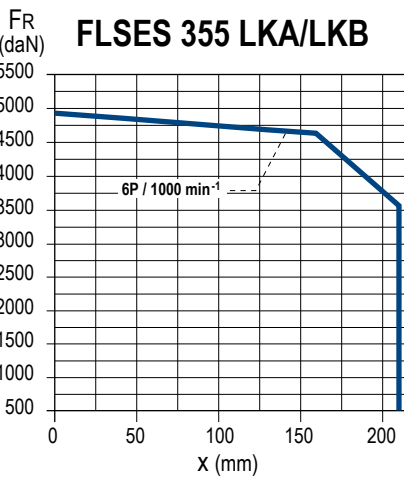
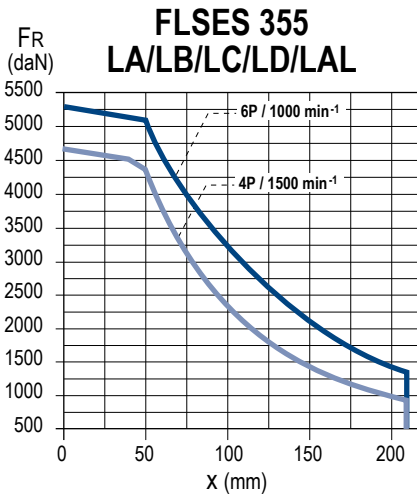
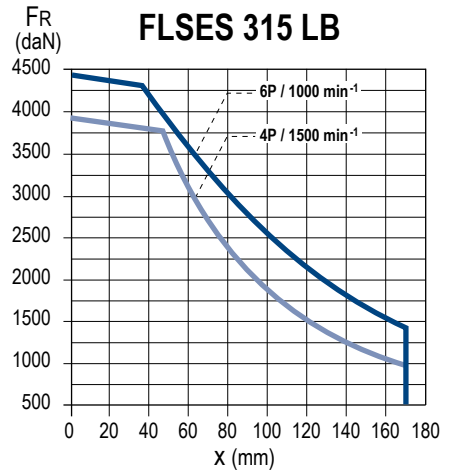
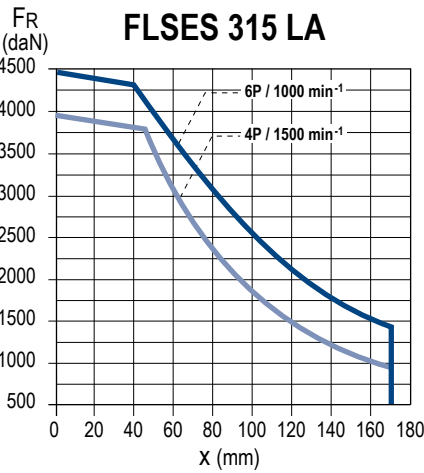
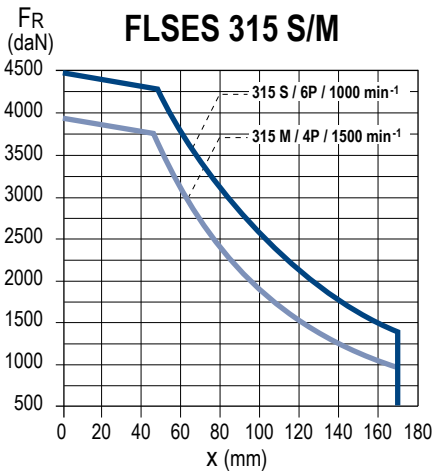

IMfinity® 3-phase induction motors - High efficiency & Premium efficiency

IP55 Cast Iron frame

Optional features

Non-standard flanges

Optionally, Leroy-Somer motors can be fitted with flanges and faceplates that are larger or smaller than standard. This means that motors can be adapted to all types of situation without the need for costly and time-consuming modifications.

The tables below give the flange and faceplate dimensions and indicate flange/motor compatibility.

The bearing and shaft extension for each frame size remain standard.

Dimensions in millimetres

(FF) Flange mounted

Symbol IEC	Flange dimensions						
	M	N	P	T	n	S	LA
FF 115	115	95	140	3	4	10	10
FF 130	130	110	160	3.5	4	10	10
FF 165	165	130	200	3.5	4	12	10
FF 215	215	180	250	4	4	15	12
FF 265	265	230	300	4	4	15	14
FF 300	300	250	350	5	4	18.5	14
FF 350	350	300	400	5	4	18.5	15
FF 400	400	350	450	5	8	18.5	16
FF 500	500	450	550	5	8	18.5	18**
FF 600	600	550*	660	6	8	24	22
FF 740	740	680*	800	6	8	24	22
FF 940	940	880*	1000	6	8	28	28
FF 1080	1080	1000*	1150	6	8	28	30

* Tolerance N js6

** LA = 22 for frame size ≥ 280

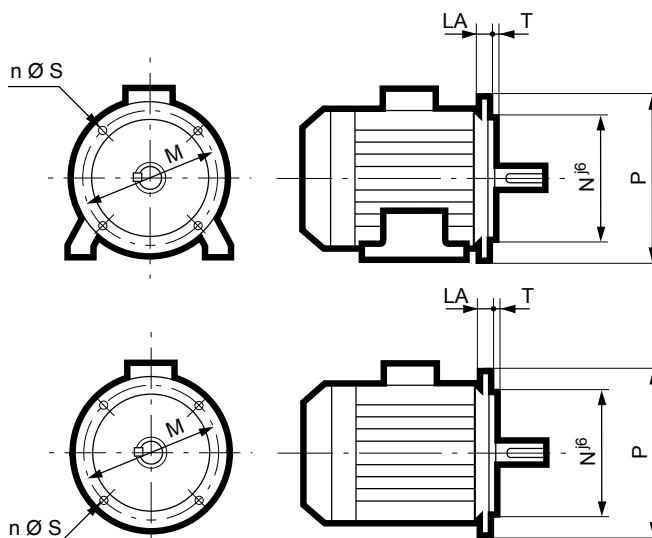

(FT) Face mounted

Symbol IEC	Faceplate dimensions					
	M	N	P	T	n	M.S
FT 85	85	70	105	2.5	4	M6
FT 100	100	80	120	3	4	M6
FT 115	115	95	140	3	4	M8
FT 130	130	110	160	3.5	4	M8
FT 165	165	130	200	3.5	4	M10
FT 215	215	180	250	4	4	M12
FT 265	265	230	300	4	4	M12

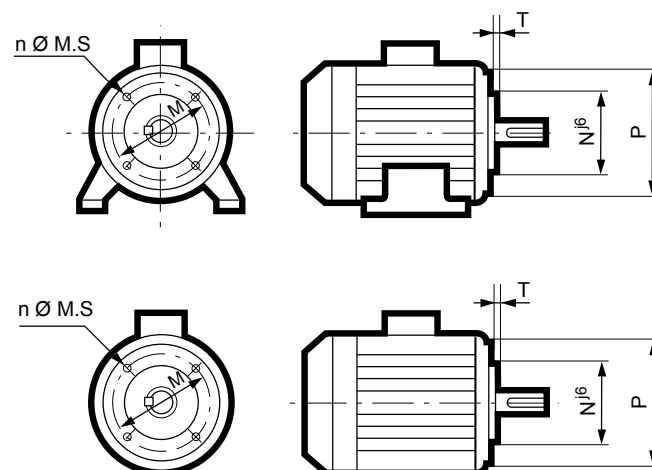

IP55 CAST IRON MOTORS

IMfinity® 3-phase induction motors - High efficiency & Premium efficiency

IP55 Cast Iron frame

Optional features

Mechanical and electrical options

BRAKE MOTORS. FORCED VENTILATION

The integration of high-efficiency motors within a process often requires accessories to make operation easier:

- forced ventilation for motors used at high or low speeds.

- Holding brakes for maintaining the rotor in the stop position without needing to leave the motor switched on.
- Emergency stop brakes to immobilise loads in case of failure of the motor torque control or loss of power supply.

Notes:

- Without forced ventilation, there is a possibility of overspeed with optional class B balancing.
- The motor temperature is monitored by sensors built into the windings.

FLSES series	LB dimensions with Forced Ventilation	
	Foot or face mounted motors	Flange mounted motor
80 L	317	
80 LG		
90 S	331	353
90 L		
90 LU		
100 L	373	
100 LK	422	
112 MG		
112 MU	412	
132 S		
132 MR	458	
132 M		
132 MU		
160 M		
160 L	641	
160 LU	702	
180 MR	641	
180 M		
180 L	689	
180 LUR		
200 LU	819	
225 SR	825,5	
225 MR		
225 M	917	
250 M		
280 S	1167	
280 M	1167	
315 S		
315 M	1477	
315 LA/LB		
355 LA/LB/LC/LD/LAL	1668	
355 LKA/LKB	1995	

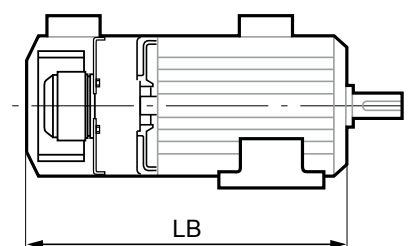

IP55 CAST IRON MOTORS

MOTORS WITH SPACE HEATERS

Type	Power (W)
FLSES 80 L	16
FLSES 80 LG to 132	25
FLSES 160 to 200	52
FLSES 225 SR/MR	
FLSES 225 M	84
FLSES 250 M	
FLSES 280 to 315	100*
FLSES 355 - FLS 355 to 450	150*

* It is possible to increase the power when asking for estimate (quotation).

The space heaters use 200/240V, single phase, 50 or 60 Hz.

IMfinity® 3-phase induction motors - High efficiency & Premium efficiency

IP55 Cast Iron frame

Installation and maintenance

Position of the lifting rings

LIFTING THE MOTOR ONLY (not coupled to the machine)

The regulations stipulate that over 25 kg, suitable handling equipment must be used.

All our motors are fitted with grab handles, making them easier to handle without risk. A diagram of the sling hoisting method appears below with the required dimensions.

To prevent any damage to the motor during handling (for example: switching the motor from horizontal to vertical), it is essential to follow these instructions.

HORIZONTAL POSITION

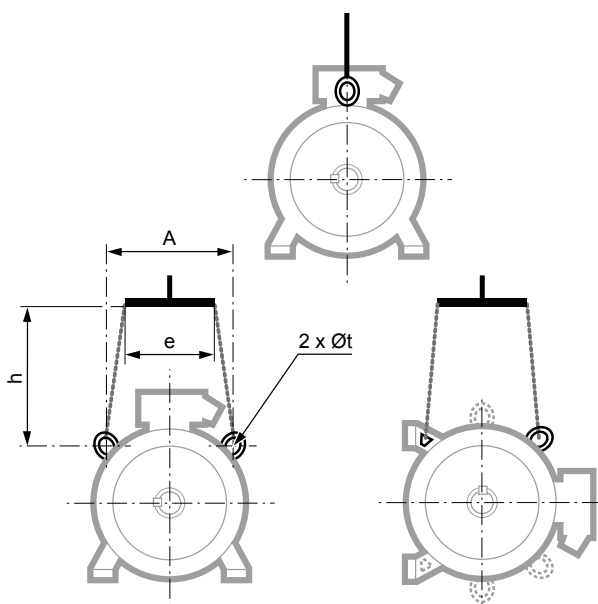

Type	Horizontal position			
	A	e min.	h min.	Øt
FLSES 100	152	200	150	22
FLSES 100 LG	145	200	150	22
FLSES 112	145	200	150	22
FLSES 132	180	200	150	25
FLSES 160 M/MU	200	260	150	14
FLSES 180 M/MUR/L/LUR	200	260	150	14
FLSES 200 LU	270	260	150	14
FLSES 225 SR/MR	270	260	150	14
FLSES 225 S/M	360	380	200	30
FLSES 250 M/MR	360	380	200	30
FLSES 280	360	380	500	30
FLSES 315 S/M/LA/LB	440	400	500	60
FLSES 355	545	500	500	60
FLSES/FLS 355 LK	685	710	500	30
FLS 400	735	710	500	30
FLS 450	730	710	500	30

VERTICAL POSITION

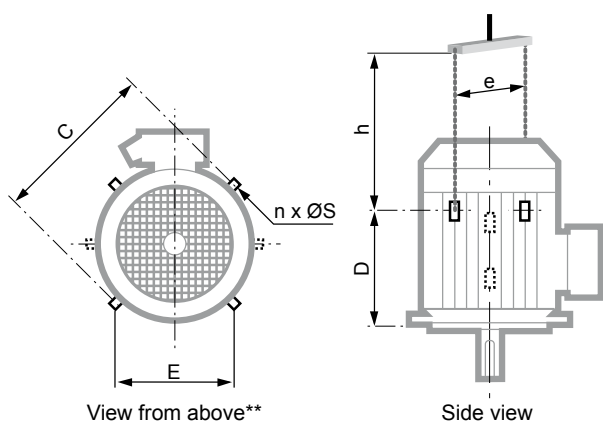

Type	Vertical position						
	C	E	D	n**	ØS	e min.*	h min.
FLSES 160 M/MU	320	200	230	2	14	320	350
FLSES 180 M/MUR/L/LUR*	320	200	230	2	14	320	270
FLSES 200 LU	410	300	295	2	14	410	450
FLSES 225 SR/MR	410	300	295	2	14	410	450
FLSES 225 S/M	480	360	405	4	30	540	350
FLSES 250 M/MR	480	360	405	4	30	590	550
FLSES 280 S	480	360	585	4	30	590	550
FLSES 280 M	480	360	585	4	30	590	550
FLSES 315 S/M/LA/LB	620	-	715	2	35	650	550
FLSES 355	760	-	750	2	35	800	550
FLSES/FLS 355 LK	810	350	1135	4	30	810	600
FLS 400	810	350	1135	4	30	810	600
FLS 450	960	400	1170	4	30	960	750

Separate ring ≤ 25 kg
Built-in ring > 25 kg

* if the motor is fitted with a drip cover, allow an additional 50 to 100 mm to avoid damaging it when the load is swung.

** if n = 2, the lifting rings form an angle of 90° with respect to the terminal box axis. If n = 4, this angle becomes 45°.

IMfinity® 3-phase induction motors - High efficiency & Premium efficiency IP23 Aluminium or Steel frame

Contents

GENERAL INFORMATION	132-133
Designation.....	132
Description.....	133
ELECTRICAL AND MECHANICAL DATA	134 to 139
IE3 powered by the mains.....	134-135
IE3 powered by the drive.....	136-137
Mains connection.....	138
DIMENSIONS.....	139 to 142
Shaft extensions	139
Foot mounted IM 1001 (IM B3).....	140
Foot and flange mounted IM 2001 (IM B35)	141
Flange mounted IM 3001 (IM B5) IM 3011 (IM V1)	142
CONSTRUCTION.....	143 to 151
Bearings and lubrication	143
Axial loads	144 to 146
Radial loads	147 to 151
OPTIONAL FEATURES	152
Mechanical options.....	152
Mechanical and electrical options	152
INSTALLATION AND MAINTENANCE.....	153
Position of the lifting rings	153

IMfinity® 3-phase induction motors - High efficiency & Premium efficiency

IP23 Aluminium or Steel frame

General information

Designation



IP 23
Cl. F - ΔT 80 K

The complete motor **reference** described below will enable you to **order** the desired equipment.

The selection method consists of following the terms in the designation.

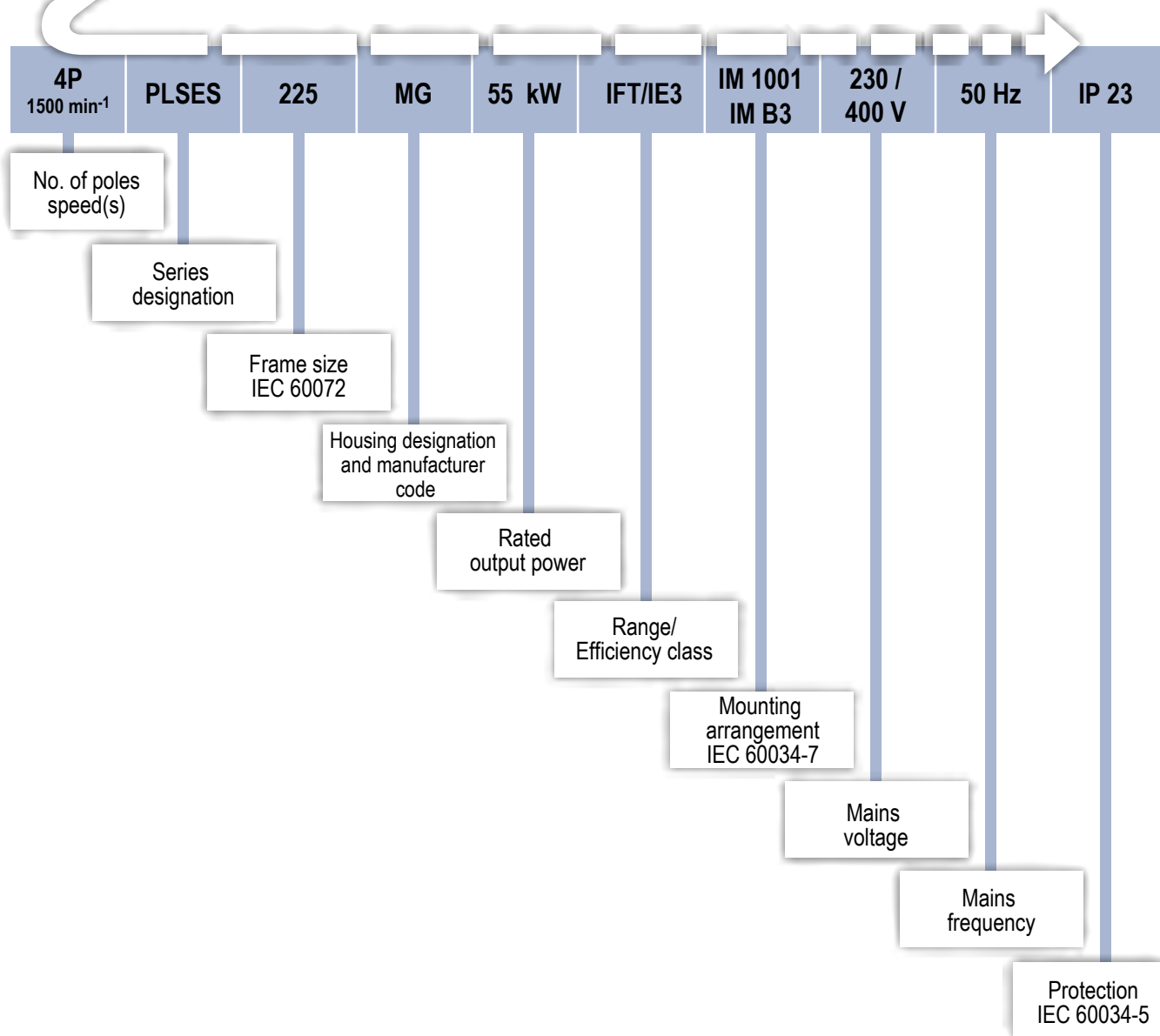

IP23 DRIP-PROOF MOTORS

IMfinity® 3-phase induction motors - High efficiency & Premium efficiency

IP23 Aluminium or Steel frame

General information

Description

Component	Materials	Remarks
Housing	Aluminium or steel	<ul style="list-style-type: none"> - aluminium: frame size 180 to 200, 250 SP/MP - steel: frame size 225 to 400 except 250 SP/MP - gravity or low pressure die casting, frame size ≤ 250 - lifting rings
Stator	Insulated low-carbon magnetic steel laminations Electroplated copper	<ul style="list-style-type: none"> - low carbon content guarantees long-term lamination pack stability - welded laminations - semi-enclosed slots - class F insulation
Rotor	Insulated low-carbon magnetic steel laminations Aluminium or copper	<ul style="list-style-type: none"> - inclined cage bars - rotor cage pressure die-cast in aluminium - rotor cage shrink-fitted to shaft - rotor balanced dynamically, class A, 1/2 key
Shaft	Steel	
End shields	Cast iron or steel	
Bearings and lubrication		Standard mounting: <ul style="list-style-type: none"> - ball bearings C3 play - permanently greased bearings for frame size ≤ 200 - regreasable bearings from frame size 225 upwards - bearings preloaded at non drive end
Labyrinth seal Lipseals	Plastic or steel Synthetic rubber	- lipseal at drive end for all motors
Fan	Composite Aluminium alloy or steel	<ul style="list-style-type: none"> - bidirectional fan in motors with 2 poles (P ≤ 250 kW), 4 poles for frame size 180 to 315 except 315 MGU and LG - unidirectional fan (direction of rotation to be specified at time of ordering) in motors with 2 poles, for frame size 315 MGU and LG
Fan cover	Pressed steel	- fitted, on request, with a drip cover for operation in vertical position, shaft end facing up
Terminal box	Composite Aluminium alloy or steel	<ul style="list-style-type: none"> - can be turned in 4 directions, opposite the feet - fitted as standard with a terminal block with 6 steel terminals - terminal box comes fitted with threaded plugs for frame size ≤ 280 SD/MD, for motors 280 MG to 315 and larger sizes, terminal box comes complete with a removable undrilled cable gland support plate, without cable gland - 1 earth terminal in each terminal box

In the standard version, the motors are wound 400 V 50 Hz with connection Δ

IMfinity® 3-phase induction motors - High efficiency & Premium efficiency IP23 Aluminium or Steel frame

Electrical and mechanical characteristics

IE3 powered by the mains

Type	Rated power	380 V 50 Hz				415 V 50 Hz				460 V 60Hz			
		Rated speed	Rated current	Efficiency	Power factor	Rated speed	Rated current	Efficiency	Power factor	Rated speed	Rated current	Efficiency	Power factor
	P _n kW	N _n min ⁻¹	I _n A	η 4/4	Cos φ 4/4	N _n min ⁻¹	I _n A	η 4/4	Cos φ 4/4	N _n min ⁻¹	I _n A	η 4/4	Cos φ 4/4
2 poles													
PLSES 225 MG	75	2968	133	95.0	0.91	2974	123	95.3	0.89	3574	110	95.0	0.90
PLSES 250 SF	90	2968	158	95.1	0.91	2976	148	95.6	0.89	3576	132	95.3	0.90
PLSES 250 MF	110	2968	195	95.2	0.90	2972	178	95.8	0.89	3576	161	95.7	0.90
PLSES 280 MD	132	2974	227	95.4	0.88	2978	215	95.6	0.84	3578	192	95.7	0.87
PLSES 315 SU	160	2972	285	95.6	0.89	2978	268	95.9	0.87	3580	237	95.9	0.88
PLSES 315 MU	200	2966	352	95.8	0.90	2974	322	96.3	0.89	3576	289	96.3	0.90
PLSES 315 L	250	2964	443	95.8	0.90	2972	411	96.2	0.88	3576	364	96.5	0.89
PLSES 315 LD	280	2966	493	96.0	0.90	2974	459	96.4	0.88	3578	408	96.3	0.89
PLSES 315 MGU	315	2869	549	95.8	0.91	2980	520	95.8	0.88	3577	459	95.8	0.90
PLSES 315 LG	355	2974	619	95.8	0.91	2980	579	95.8	0.89	3577	517	95.8	0.90
PLS 315 LG*	400	2962	732	94.3	0.88	2967	683	94.7	0.86	3565	612	94.3	0.87
PLS 315 VLG*	450	2972	820	95.0	0.88	2977	764	95.3	0.86	3575	683	95.0	0.87
PLS 355 LA*	500	2976	908	95.1	0.88	2976	860	95.2	0.85	3580	756	95.4	0.87
PLS 355 LB*	710	2976	1275	95.1	0.89	2976	1200	95.7	0.86	3580	1061	95.4	0.88
4 poles													
PLSES 225 MG	55	1480	105	94.6	0.84	1486	99.1	95.0	0.82	1790	89.7	95.4	0.81
PLSES 250 SF	75	1484	142	95.0	0.85	1488	136	95.1	0.81	1790	122	95.4	0.81
PLSES 250 MF	90	1484	171	95.3	0.84	1488	164	95.7	0.8	1790	145	95.6	0.81
PLSES 280 SGU	110	1488	206	95.4	0.85	1490	193	95.6	0.83	1790	174	95.8	0.83
PLSES 280 MGU	132	1486	247	95.6	0.85	1490	231	96.0	0.83	1790	205	96.2	0.84
PLSES 315 SUR	160	1488	300	95.8	0.85	1492	286	96.0	0.81	1790	253	96.2	0.82
PLSES 315 MUR	200	1484	371	96.0	0.85	1488	357	96.1	0.81	1790	317	96.3	0.82
PLSES 315 LUS	250	1484	466	96.0	0.85	1488	446	96.2	0.81	1790	398	96.4	0.82
PLSES 315 LG	280	1484	526	96.3	0.84	1485	504	96.6	0.80	1788	446	96.0	0.82
PLSES 315 LG	315	1484	573	96.0	0.87	1488	542	96.3	0.84	1787	484	96.2	0.85
PLSES 315 LG	355	1486	660	96.1	0.85	1489	651	96.0	0.79	1788	565	96.2	0.82
PLSES 315 VLG	400	1485	744	96.1	0.85	1489	713	96.4	0.81	1786	629	96.2	0.83
PLSES 315 VLG	450	1481	828	96.0	0.86	1485	784	96.2	0.83	1784	699	96.2	0.84
PLS 315 VLGU*	500	1477	937	94.3	0.86	1479	883	94.9	0.83	1777	781	94.5	0.85
PLS 355 LA*	550	1485	1022	95.1	0.86	1489	967	95.3	0.83	1787	851	95.4	0.85
PLS 355 LB*	685	1586	1273	95.1	0.86	1490	1205	95.3	0.83	1788	1060	95.4	0.85
PLS 400 LA*	720	1489	1333	95.4	0.86	1492	1258	95.9	0.83	1791	1114	95.4	0.85
PLS 400 LB*	900	1489	1667	95.4	0.86	1492	1573	95.9	0.83	1791	1393	95.4	0.85
6 poles													
PLS 355 LA*	370	988	712	95.1	0.83	992	684	95.2	0.79	1190	604	95	0.81
PLS 355 LB*	450	988	866	95.1	0.83	992	832	95.2	0.79	1190	734	95	0.81
PLS 400 LA*	500	988	962	95.1	0.83	992	913	95.2	0.8	1190	816	95	0.81
PLS 400 LB*	600	988	1155	95.1	0.83	992	1096	95.2	0.8	1190	979	95	0.81

* IE2 efficiency class

IMfinity® 3-phase induction motors - High efficiency & Premium efficiency IP23 Aluminium or Steel frame

Electrical and mechanical characteristics

IE3 powered by the drive

Type	400 V 50 Hz				% Rated torque M_n at					400 V 87 Hz Δ^1				Maximum mechanical speed ²
	Rated power	Rated speed	Rated current	Power factor	10 Hz	17 Hz	25 Hz	50 Hz	87 Hz	Rated power	Rated speed	Rated current	Power factor	
	P_n kW	N_n min ⁻¹	I_n A	$\cos \varphi$ 4/4						P_n kW	N_n min ⁻¹	I_n A	$\cos \varphi$ 4/4	
2 poles														
PLSES 225 MG	75	2964	144	0.90	80%	90%	100%	100%	-	-	-	-	-	3600
PLSES 250 SF	90	2966	172	0.90	80%	90%	100%	100%	-	-	-	-	-	3600
PLSES 250 MF	110	2960	210	0.90	80%	90%	100%	100%	-	-	-	-	-	3600
PLSES 280 MD	127	2962	223	0.87	77%	86%	96%	96%	-	-	-	-	-	3600
PLSES 315 SU	160	2970	306	0.88	80%	90%	100%	100%	-	-	-	-	-	3600
PLSES 315 MU	200	2960	389	0.90	80%	90%	100%	100%	-	-	-	-	-	3600
PLSES 315 L	207	2956	402	0.89	66%	74%	83%	83%	-	-	-	-	-	3600
PLSES 315 LD	245	2962	408	0.89	70%	79%	87%	87%	-	-	-	-	-	3600
PLSES 315 MGU	315	2972	583	0.90	75%	85%	100%	100%	-	-	-	-	-	3580
PLSES 315 LG	355	2977	648	0.90	75%	85%	100%	100%	-	-	-	-	-	3580
4 poles														
PLSES 225 MG	55	1478	112	0.83	80%	90%	100%	100%	57%	95.7	2588	194.79	0.83	3240
PLSES 250 SF	75	1480	155	0.83	80%	90%	100%	100%	57%	130.5	2590	269.84	0.83	3240
PLSES 250 MF	90	1482	186	0.82	80%	90%	100%	100%	57%	156.6	2592	323.45	0.82	3240
PLSES 280 SGU	110	1486	223	0.84	80%	90%	100%	100%	57%	191.4	2596	387.78	0.84	2700
PLSES 280 MGU	132	1484	266	0.84	80%	90%	100%	100%	57%	229.68	2594	462.84	0.84	2700
PLSES 315 SUR	160	1486	320	0.83	80%	90%	100%	100%	57%	278.4	2596	557.55	0.83	3420
PLSES 315 MUR	200	1482	396	0.83	80%	90%	100%	100%	57%	348	2592	689.79	0.83	3420
PLSES 315 LUS	250	1482	499	0.83	80%	90%	100%	100%	57%	435	2592	868.5	0.83	3420
PLSES 315 LG	280	1488	535	0.85	75%	83%	100%	100%	57%	280	2610	535	0.85	2610
PLSES 315 LG	315	1486	606	0.86	69%	75%	89%	100%	58%	315	2610	606	0.86	2610
PLSES 315 LG	355	1487	682	0.85	77%	84%	100%	100%	58%	355	2610	682	0.85	2610
PLSES 315 VLG	400	1486	754	0.85	75%	86%	100%	100%	58%	400	2610	754	0.85	2610
PLSES 315 VLG	450	1484	857	0.87	70%	80%	100%	100%	58%	450	2610	857	0.87	2610

(1) Data only valid for: 400 V 50 Hz Y motors and frame size ≤ 250 mm - 2 poles

(2) See Vibrations section on page 48



- Please refer to page 38 for variable speed applications
- Values given with a voltage drop of 30V at the drive output

IMfinity® 3-phase induction motors - High efficiency & Premium efficiency IP23 Aluminium or Steel frame

Electrical and mechanical characteristics

IE3 powered by the drive

Summary of recommended protection devices

Mains voltage	Cable length	Frame size	Winding protection	Insulated bearings
≤ 480 V	< 20 m	All frame sizes	Standard	No
	> 20 m and < 100 m	< 315	Standard	No
		≥ 315	RIS or drive filter	NDE
> 480 V and ≤ 690 V	< 20 m	< 250	Standard	No
		≥ 250	RIS or drive filter	NDE
	> 20 m and < 100 m	< 250	RIS or drive filter	NDE
		≥ 250	RIS or drive filter	NDE
		≥ 250	RIS or drive filter	NDE (or DE+NDE if no filter for ≥ 315)

RIS: Reinforced Insulation System.

The filter is recommended above frame size 315.

Standard insulation = 1500 V peak and 3500 V/μs.

Service solutions exist (insulation for winding and bearings).

For different cable length(s) and/or voltage(s), please consult Leroy-Somer.

Motors of frame size ≥ 250 kW with RIS protection are no longer cURus.



REMINDER: All 2, 4 and 6 pole motors placed on the EU market must be IE3 or IE2 and used with a variable speed drive:

- from 01/01/2015 for power ratings from 7.5 to 375 kW
- from 01/01/2017 for power ratings from 0.75 to 375 kW

Other drive mechanism solutions:



LSRPM: permanent magnet synchronous motors 0.75 to 375 kW

Variable speed application, requiring IP55 protection, high efficiency and/or compact dimensions.



CPLS: induction motors 95 to 1600 Nm

Application for variable speed operation requiring constant power over a wide speed range.



LSMV: induction motors 0.25 to 132 kW

Application for variable speed operation requiring constant torque over a wide speed range.



LSK: D.C. motors 2 to 750 kW



UNIMOTOR FM and HD: servomotors 0.7 to 410 Nm

IP23 DRIP-PROOF MOTORS

IMfinity® 3-phase induction motors - High efficiency & Premium efficiency

IP23 Aluminium or Steel frame

Electrical and mechanical characteristics

Mains connection

DESCRIPTIVE TABLE OF TERMINAL BOXES FOR 400 V RATED SUPPLY VOLTAGE (in accordance with EN 50262)

Series	Type	No. of poles	Terminal box material	Power + auxiliaries	
				Number of drill holes	Drill hole diameter
PLSES	225	2; 4	Aluminium alloy	3	2xM63 + 1xM16
	250	2; 4			
	280 MD/SD	2; 4			
PLSES/PLS	280 SG/MG - 315 to 400	2; 4		0	Removable undrilled mounting plate

TERMINAL BLOCKS DIRECTION OF ROTATION

Standard motors are fitted with a block of 6 terminals complying with standard NFC 51 120, with the terminal markings complying with IEC 60034-8 (or NF EN 60034-8).

When the motor is running in U1, V1, W1 or 1U, 1V, 1W from a direct mains supply L1, L2, L3, it turns clockwise when seen from the drive shaft end.

If any two of the phases are changed over, the motor will run in an anti-clockwise direction (make sure that the motor has been designed to run in both directions).

If the motor is fitted with accessories (thermal protection or space heater), these must be connected on screw dominos with labelled wires.

Tightening torque for the nuts on the terminal blocks.

Terminal	M8	M10	M12	M14	M16
Torque N.m	10	20	35	50	65

Series	Type	230/400 V connections		400/690 V connections
		No. of poles	Terminals	Terminals
PLSES	225 MG	4	M10	M8
	225 MG	2	M12	M10
	250 MF	2; 4		
	280	2; 4	M16	M12
	315 SU/MU/SUR/MUR	4		
	315 L/LD/LUS	2; 4	M16	M16
PLSES/PLS	315 VLG/LG/MGU	2; 4	M12	M12
PLS	315 VLGU	2; 4	M12	M12
	355/400	2; 4	M14	M14

IMfinity® 3-phase induction motors - High efficiency & Premium efficiency IP23 Aluminium or Steel frame

Dimensions

Shaft extensions

Dimensions in millimetres

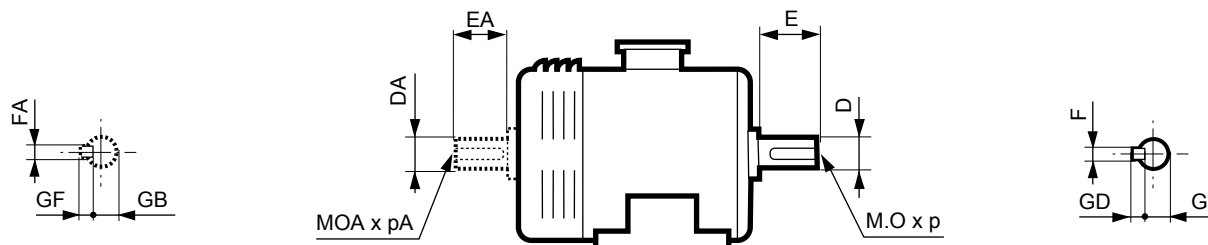

Type	Main shaft extensions													
	4 poles							2 poles						
	F	GD	D	G	E	O	p	F	GD	D	G	E	O	p
PLSES 225 MG	18	11	65m6	58	140	20	42	18	11	60m6	53	140	20	42
PLSES 250 MF	20	12	75m6	67.5	140	20	42	18	11	65m6	58	140	20	42
PLSES 250 SF	20	12	75m6	67.5	140	20	42	18	11	65m6	58	140	20	42
PLSES 280 MD/MGU/SGU	22	14	80m6	71	170	20	42	18	11	65m6	58	140	20	42
PLSES 315 S/SUR/L/LD/M/MUR	25	14	90m6	81	170	24	50	20	12	70m6	62.5	140	20	42
PLSES 315 SU	25	14	90m6	81	170	24	50	20	12	70m6	62.5	140	24	50
PLSES 315 LUS	25	14	90m6	81	170	24	50	22	14	80m6	71	170	20	42
PLSES 315 MU	25	14	90m6	81	170	24	50	20	12	70m6	62.5	140	20	42
PLSES 315 LG/MGU	28	16	100m6	90	210	24	50	22	14	80m6	71	170	20	42
PLSES 315 VLG	28	16	100m6	90	210	24	50	-	-	-	-	-	-	-
PLS 315 VLGU	28	16	100m6	90	210	24	50	-	-	-	-	-	-	-
PLS 315 LG/VLG	-	-	-	-	-	-	-	22	14	80m6	71	170	20	42
PLS 355 LA/LB	28	16	110m6	100	210	24	50	22	14	80m6	71	170	20	42
PLS 400 LA/LB	32	18	120m6	109	210	24	50	-	-	-	-	-	-	-

Type	Secondary shaft extensions													
	4 poles							2 poles						
	FA	GF	DA	GB	EA	OA	pA	FA	GF	DA	GB	EA	OA	pA
PLSES 225 MG	18	11	65m6	58	140	20	42	18	11	60m6	53	140	20	42
PLSES 250 MF	20	12	65m6	58	140	20	42	18	11	65m6	58	140	20	42
PLSES 250 SF	18	11	65m6	58	140	20	42	18	11	65m6	58	140	20	42
PLSES 280 MD/MGU/SGU	20	12	65m6	58	140	20	42	18	11	65m6	58	140	20	42
PLSES 280 SGU	18	11	65m6	58	140	20	42	18	11	65m6	58	140	20	42
PLSES 315 S/SUR/L/LD/M/MUR	20	12	75m6	67.5	140	20	42	18	11	70m6	62.5	140	20	42
PLSES 315 SU	20	12	75m6	67.5	140	20	42	18	11	70m6	62.5	140	20	42
PLSES 315 LUS	20	12	75m6	67.5	140	20	42	18	11	70m6	62.5	140	20	42
PLSES 315 MU	20	12	75m6	67.5	140	20	42	18	11	70m6	62.5	140	20	42
PLSES 315 LG/MGU	22	14	80m6	71	170	20	42	22	14	80m6	71	170	20	42
PLSES 315 VLG	22	14	80m6	71	170	20	42	-	-	-	-	-	-	-
PLS 315 VLGU	22	14	80m6	71	170	20	42	-	-	-	-	-	-	-
PLS 315 LG/VLG	-	-	-	-	-	-	-	22	14	80m6	71	170	20	42
PLS 355 LA/LB	28	16	110m6	100	210	24	50	22	14	80m6	71	170	20	42
PLS 400 LA/LB	32	18	120m6	109	210	24	50	-	-	-	-	-	-	-

IP23 DRIP-PROOF MOTORS

IMfinity® 3-phase induction motors - High efficiency & Premium efficiency

IP23 Aluminium or Steel frame

Dimensions

Foot mounted IM 1001 (IM B3)

Dimensions in millimetres

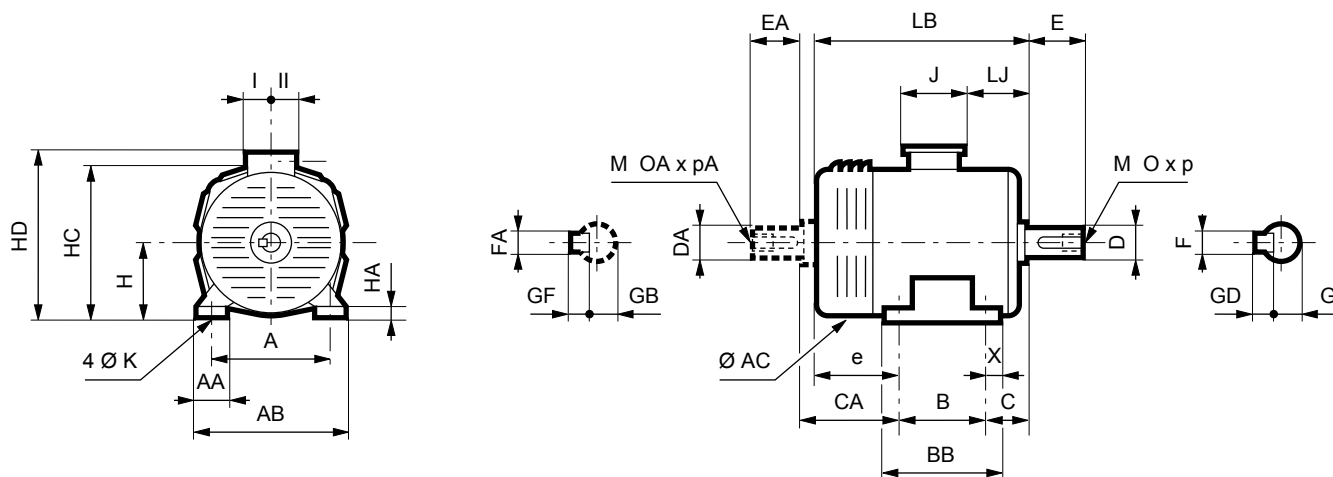

Type	Main dimensions																
	A	AB	B	BB	C	X	AA	K	HA	H	AC	HD	LB	LJ	J	I	II
PLSES 225 MG	356	416	311	351	149	20	60	19	26	225	443	629	824	175.5	292	151	181
PLSES 250 MF	406	466	349	397	168	24	60	24	26	250	443	654	904	209	292	151	181
PLSES 250 SF	406	466	349	397	168	24	60	24	26	250	443	654	904	209	292	151	181
PLSES 280 MD	457	517	419	467	190	24	60	24	26	280	443	684	904	209	292	151	181
PLSES 280 MGU/SGU	457	537	419	499	190	40	80	24	27	280	548	830	1024	242	420	180	235
PLSES 315 L	508	368	508	588	216	40	100	28	26	315	548	860	1026	242	418	180	235
PLSES 315 LD	508	608	508	588	216	40	100	28	26	315	548	860	1086	242	418	180	235
PLSES 315 LG	508	608	508	588	216	40	100	28	26	315	629	876	1261	248	428	206	202
PLSES 315 LUS	508	608	508	588	216	40	100	28	26	315	548	865	1106	242	420	180	235
PLSES 315 M	508	608	457	537	216	40	100	28	26	315	600	860	940	242	418	180	235
PLSES 315 MGU	508	608	457	588	216	40	100	28	26	315	629	876	1261	248	428	206	202
PLSES 315 MUR	508	608	457	537	216	40	100	28	26	315	600	860	1104	242	418	180	235
PLSES 315 MU	508	608	457	537	216	40	100	28	26	315	600	862	1025	242	418	180	235
PLSES 315 S	508	608	406	486	216	40	100	28	26	315	600	860	881	242	418	180	235
PLSES 315 SU	508	608	406	486	216	40	100	28	26	315	600	862	940	242	418	180	235
PLSES 315 SUR	508	608	406	486	216	40	100	28	26	315	600	860	1024	242	418	180	235
PLSES 315 VLG	508	608	560	640	216	40	100	28	26	315	629	876	1321	248	428	206	202
PLS 315 VLGU	508	608	560	640	216	40	100	27	26	315	660	890	1261	248	428	205	195
PLS 315 LG/VLG	508	608	560	640	216	40	100	27	26	315	660	890	1191	248	428	205	195
PLS 355 LA/LB	610	710	630	710	254	30	100	28	26	355	705	1078	1470	130	700	224	396
PLS 400 LA/LB	686	806	710	800	280	45	80	35	26	400	795	1173	1755	177	700	224	396

IP23 DRIP-PROOF MOTORS

IMfinity® 3-phase induction motors - High efficiency & Premium efficiency IP23 Aluminium or Steel frame

Dimensions

Foot and flange mounted IM 2001 (IM B35)

Dimensions in millimetres

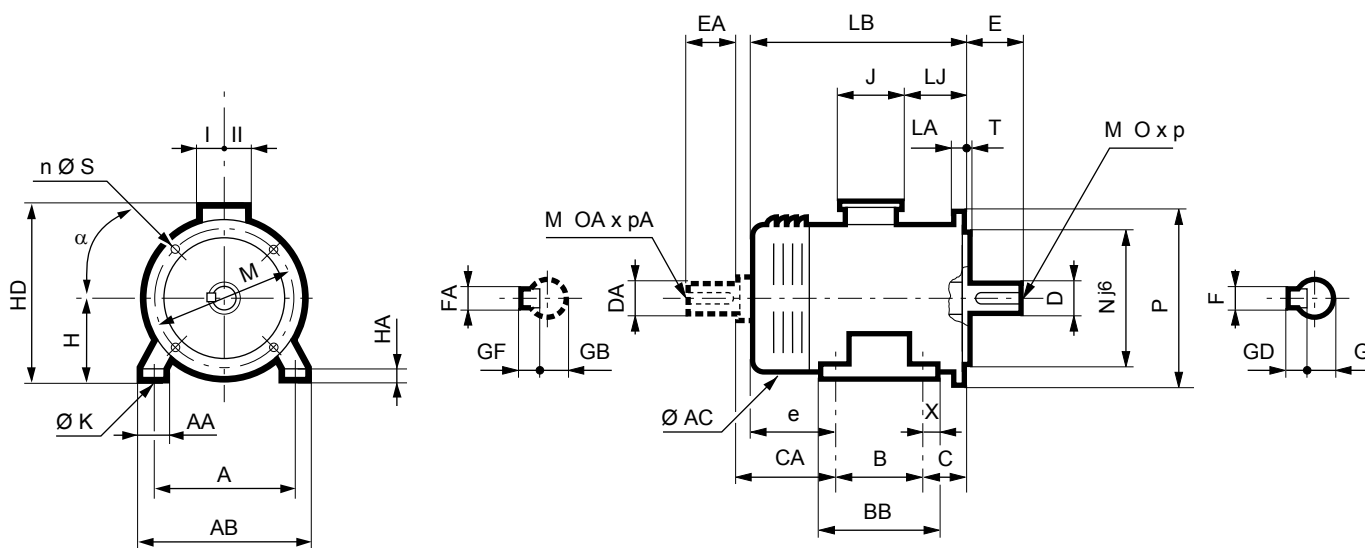

Type	Main dimensions																		
	A	AB	B	BB	C	X	AA	K	HA	H	AC	HD	HJ	LB	LJ	J	I	II	Symbol
PLSES 225 MG	356	416	311	351	149	20	60	19	26	225	443	629	404	824	175.5	292	151	181	FF 500
PLSES 250 MF*	406	466	349	397	168	24	60	24	26	250	443	654	404	904	209	292	151	181	FF 600
PLSES 250 SF*	406	470	311	400	168	26	94	24	40	250	443	643	404	904	209	292	151	181	FF 600
PLSES 280 MD*	457	517	419	467	190	24	60	24	26	280	443	684	404	904	209	292	151	181	FF 600
PLSES 280 SGU*	457	537	368	499	190	40	80	24	27	280	548	825	545	1038	242	418	180	236	FF 600
PLSES 280 MGU*	457	537	419	499	190	40	80	24	27	280	548	825	545	1038	242	418	180	236	FF 600
PLSES 315 L*	508	608	508	588	216	40	100	28	26	315	548	860	545	1026	242	418	180	236	FF 740
PLSES 315 LD*	508	608	508	588	216	40	100	28	26	315	548	860	545	1086	242	418	180	236	FF 740
PLSES 315 LG*	508	608	508	588	216	40	100	28	26	315	629	876	561	1261	248	428	206	202	FF 740
PLSES 315 LUS*	508	608	508	588	216	40	100	28	26	315	548	860	545	1106	242	418	180	236	FF 740
PLSES 315 M*	508	608	457	537	216	40	100	28	26	315	600	860	545	940	242	418	180	236	FF 740
PLSES 315 MGU*	508	608	457	537	216	40	100	28	26	315	629	876	561	1261	248	428	206	202	FF 740
PLSES 315 MUR*	508	608	457	537	216	40	100	28	26	315	600	862	545	1118	242	418	180	236	FF 740
PLSES 315 MU*	508	608	457	588	216	40	100	27	26	315	600	890	547	1025	242	418	180	235	FF 740
PLSES 315 S*	508	608	406	486	216	40	100	28	26	315	600	860	545	881	242	418	180	236	FF 740
PLSES 315 SU*	508	608	406	486	216	40	100	28	26	315	600	862	547	940	242	418	180	235	FF 740
PLSES 315 SUR*	508	608	406	486	216	40	100	28	26	315	600	860	545	1038	242	418	180	236	FF 740
PLSES 315 VLG*	508	608	560	640	216	40	100	28	26	315	629	876	561	1321	248	428	206	202	FF 740
PLS 315 VLGU	508	608	560	640	216	40	100	27	26	315	660	890	575	1261	248	428	205	195	FF 740
PLS 315 LG/VLG	508	608	560	640	216	40	100	27	26	315	660	890	575	1191	248	428	205	195	FF 740
PLS 355 LA/LB	610	710	630	710	254	30	100	28	26	355	705	1078	723	1470	130	700	224	396	FF 940
PLS 400 LA/LB	686	806	710	800	280	45	80	35	26	400	795	1173	773	1755	177	700	224	396	FF 940

* For frame size ≥ 250 mm used as IM B5 (IM 3001), please consult Leroy-Somer.

IEC symbol	Flange dimensions							
	M	N	P	T	n	α°	s	LA
FF 400	400	350	450	5	8	22.5	18.5	16
FF 500	500	450	550	5	8	22.5	18.5	18
FF 600	600	550	660	6	8	22.5	22	25
FF 740	740	680	800	6	8	22.5	22	25
FF 940	940	880	1000	6	8	22.5	28	28
FF 1080	1080	1000	1150	6	8	22.5	28	30

IP23 DRIP-PROOF MOTORS

IMfinity® 3-phase induction motors - High efficiency & Premium efficiency

IP23 Aluminium or Steel frame

Dimensions

Flange mounted IM 3001 (IM B5) IM 3011 (IM V1)

Dimensions in millimetres

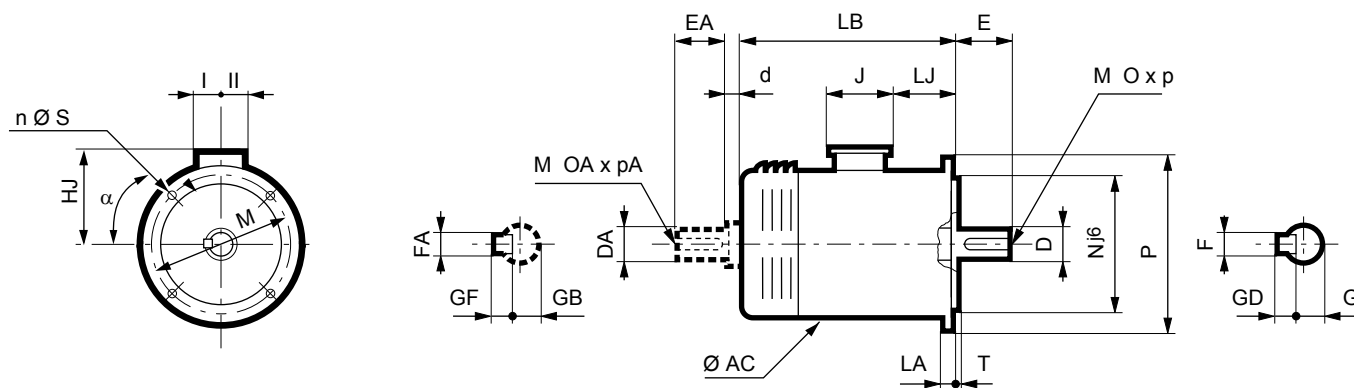

Type	Main dimensions								Symbol
	AC	HJ	LB	LJ	J	I	II		
PLSES 225 MG	443	404	824	175.5	292	151	181	FF 500	
PLSES 250 MF*	443	404	904	209	292	151	181	FF 600	
PLSES 250 SF*	443	404	904	209	292	151	181	FF 600	
PLSES 280 MD*	443	404	904	209	292	151	181	FF 600	
PLSES 280 MGU*	548	545	1038	242	418	180	236	FF 600	
PLSES 280 SGU*	548	545	1038	242	418	180	236	FF 600	
PLSES 315 L*	548	545	1026	242	418	180	236	FF 740	
PLSES 315 LD*	548	545	1086	242	418	180	236	FF 740	
PLSES 315 LG*	629	561	1261	249	428	206	202	FF 740	
PLSES 315 LUS*	548	545	1106	242	418	180	236	FF 740	
PLSES 315 M*	600	545	940	242	418	180	236	FF 740	
PLSES 315 MGU*	629	561	1261	249	428	206	202	FF 740	
PLSES 315 MUR*	600	545	1118	242	418	180	236	FF 740	
PLSES 315 MU*	600	547	1025	242	418	180	235	FF 740	
PLSES 315 S*	600	545	881	242	418	180	236	FF 740	
PLSES 315 SU*	600	547	940	242	418	180	235	FF 740	
PLSES 315 SUR*	600	545	1038	242	418	180	236	FF 740	
PLSES 315 VLG*	629	561	1321	249	428	206	202	FF 740	
PLS 315 VLGU	660	575	1261	248	428	205	195	FF 740	
PLS 315 LG/VLG	660	575	1191	248	428	205	195	FF 740	
PLS 355 LA/LB	705	723	1470	130	700	224	396	FF 940	
PLS 400 LA/LB	795	773	1755	177	700	224	396	FF 940	

* For frame size ≥ 250 mm used as IM B5 (IM 3001), please consult Leroy-Somer.

Symbol IEC	Flange dimensions							
	M	N	P	T	n	α°	s	LA
FF 400	400	350	450	5	8	22.5	18.5	16
FF 500	500	450	550	5	8	22.5	18.5	18
FF 600	600	550	660	6	8	22.5	22	25
FF 740	740	680	800	6	8	22.5	22	25
FF 940	940	880	1000	6	8	22.5	28	28
FF 1080	1080	1000	1150	6	8	22.5	28	30

IMfinity® 3-phase induction motors - High efficiency & Premium efficiency

IP23 Aluminium or Steel frame

Construction

Bearings and lubrication

BEARINGS WITH GREASE NIPPLES

The chart opposite shows the greasing intervals, depending on the type of motor, for standard bearing assemblies of frame size ≥ 250 mm fitted with grease nipples, operating at an ambient temperature of 25°C, 40°C and 55°C on a horizontal shaft machine.

The chart below is valid for PLSES/PLS motors lubricated with Polyrex EM103 grease, which is used as standard.

SPECIAL CONSTRUCTION AND ENVIRONMENT

For vertical shaft machines, the greasing intervals will be approximately 80% of the values stated in the table below.

Note: The quality and quantity of grease and the greasing interval are shown on the machine nameplate.

For special assemblies (motors fitted with DE roller bearings or other types), machines of frame size ≥ 160 mm have bearings with grease nipples.

Instructions for bearing maintenance are given on the nameplates on these machines.

Series	Type	No. of poles	Type of bearing for bearings with grease nipples		Quantity of grease g	Greasing intervals in hours														
			N.D.E.	D.E.		3000 min ⁻¹			1500 min ⁻¹											
						25°C	40°C	55°C	25°C	40°C	55°C									
PLSES	225 MG	2; 4	6314 C3	6317 C3	40	8000	4000	2000	19600	9800	4900									
	250 SF																			
	250 MF																			
	280 MD	2	6316 C3	6320 C3	50	-	-	-	15800	7900	3950									
	280 SGU	4																		
	280 MGU	4																		
	315 SUR	4																		
	315 LUS	4																		
	315 SU	2																		
	315 MU	2																		
	315 L	2																		
315 LD	2																			
PLSES/PLS	315 LG/MGU	2										6317 C3	6317 C3	35	6500	6500	4095	-	-	-
		4										6317 C3	6322 C3	55	-	-	-	13200	13200	8316
	315 VLG/VLGU	2	6317 C3	6317 C3	35	6500	6500	4095	-	-	-									
		4	6317 C3	6322 C3	55	-	-	-	13200	13200	8316									
	355 L	2	6317 C3	6317 C3	35	6500	6500	4095	-	-	-									
		4	6324 C3	6324 C3	72	-	-	-	7500	3700	2800									
	400 L	4	6328 C3	6328 C3	93	-	-	-	4600	2300	1100									

* bearing with grease nipples on request

STANDARD BEARING FITTING ARRANGEMENTS

PLSES series		Horizontal shaft	Vertical shaft	
			Shaft facing down	Shaft facing up
Foot mounted motors	Mounting arrangement	B3	V5	V6
	standard mounting	The DE bearing is: - located at DE for frame 180 - locked for frame ≥ 200	The DE bearing is: - located at DE for frame 180 - locked for frame ≥ 200	The DE bearing is locked
	on request	DE bearing locked for frame 180	The DE bearing is locked for frame 180	
Flange mounted motors (or foot and flange)	Mounting arrangement	B5/B35	V1/V15	V3/V36
	standard mounting	The DE bearing is locked	The DE bearing is locked	The DE bearing is locked

IP23 DRIP-PROOF MOTORS

IMfinity® 3-phase induction motors - High efficiency & Premium efficiency IP23 Aluminium or Steel frame Construction

Axial loads

HORIZONTAL MOTOR

For a bearing life L_{10h}
of 25,000 hours
and 40,000 hours

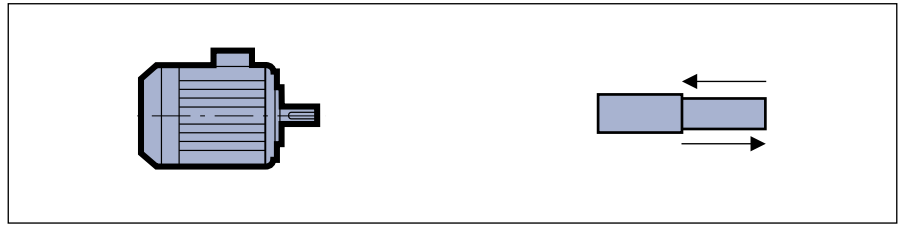

Series	Type	No. of poles	Permissible axial load (in daN) on main shaft extension for standard bearing assembly							
			3000 min ⁻¹				1500 min ⁻¹			
			25 000 hours	40 000 hours	25 000 hours	40 000 hours	25 000 hours	40 000 hours	25 000 hours	40 000 hours
			IM B3/B6 IM B7/B8 IM B5/B35							
PLSES	225 MG	2; 4	474	390	394	310	607	494	527	414
	250 SF	2; 4	469	385	389	305	581	470	501	390
	250 MF	4	460	377	380	297	554	445	474	365
	280 MD	2	376	293	456	373	-	-	-	-
	280 SGU	4	-	-	-	-	798	656	618	476
	280 MGU	4	-	-	-	-	794	652	614	472
	315 L	2	457	380	277	200	-	-	-	-
	315 LD	2	380	316	200	136	-	-	-	-
	315 SU	2	473	395	293	215	-	-	-	-
	315 MU	2	460	383	280	203	-	-	-	-
	315 SUR	4	-	-	-	-	787	645	607	465
	315 MUR	4	-	-	-	-	763	623	583	443
PLSES/PLS	315 LUS	2	758	618	578	438	-	-	-	-
	315 LG/MGU	2; 4	504	417	364	277	860	703	720	563
	315 VLG	2; 4	508	-	208	-	880	-	580	-
	315 VLGU	4	-	-	-	-	846	-	546	-
	355 L/LA/LB	2; 4	135	-	415	-	414	-	694	-
	400 L/LA/LB	4	-	-	-	-	552	-	906	-

IMfinity® 3-phase induction motors - High efficiency & Premium efficiency

IP23 Aluminium or Steel frame

Construction

Axial loads

VERTICAL MOTOR SHAFT FACING DOWN

For a bearing life L_{10h}
of 25,000 hours
and 40,000 hours

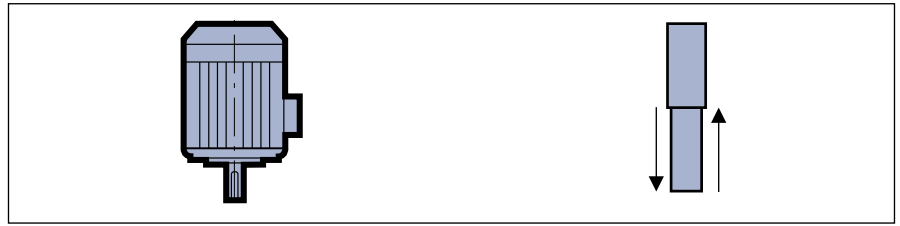

Series	Type	No. of poles	Permissible axial load (in daN) on main shaft extension for standard bearing assembly							
			3000 min ⁻¹				1500 min ⁻¹			
			25 000 hours	40 000 hours	25 000 hours	40 000 hours	25 000 hours	40 000 hours	25 000 hours	40 000 hours
			IM V5 IM V1/V15							
PLSES	225 MG	2; 4	400	315	506	421	506	392	684	570
	250 SF	2; 4	383	298	518	433	464	351	694	581
	250 MF	4	365	280	529	444	432	320	691	579
	280 MD	2	282	198	605	520	-	-	-	-
	280 SGU	4	-	-	-	-	605	460	929	784
	280 MGU	4	-	-	-	-	579	434	951	806
	315 L	2	302	222	518	439	-	-	-	-
	315 LD	2	196	129	482	415	-	-	-	-
	315 SU	2	341	261	493	413	-	-	-	-
	315 MU	2	316	236	507	428	-	-	-	-
	315 SUR	4	-	-	-	-	575	427	947	803
	315 MUR	4	-	-	-	-	522	378	978	834
	315 LUS	2	503	359	991	847	-	-	-	-
PLSES/PLS	315 LG/MGU	2; 4	390	300	550	457	610	445	1124	957
	315 VLG	2; 4	270	-	580	-	557	-	1085	-
	315 VLGU	4	-	-	-	-	483	-	1125	-
	355 L/LA/LB	2; 4	402	-	396	-	573	-	893	-
	400 L/LA/LB	4	-	-	-	-	568	-	1309	-

IP23 DRIP-PROOF MOTORS

IMfinity® 3-phase induction motors - High efficiency & Premium efficiency

IP23 Aluminium or Steel frame

Construction

Axial loads

VERTICAL MOTOR SHAFT FACING UP

For a bearing life L_{10h} of 25,000 hours and 40,000 hours

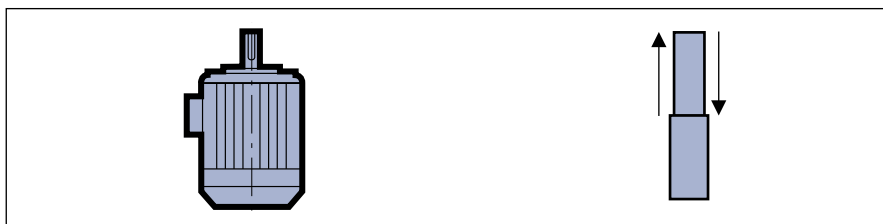

Series	Type	No. of poles	Permissible axial load (in daN) on main shaft extension for standard bearing assembly							
			3000 min ⁻¹				1500 min ⁻¹			
			25 000 hours	40 000 hours	25 000 hours	40 000 hours	25 000 hours	40 000 hours	25 000 hours	40 000 hours
			IM V6 IM V3/V36							
PLSES	225 MG	2; 4	320	235	586	501	426	312	764	650
	250 SF	2; 4	303	218	598	513	384	661	774	271
	250 MF	4	285	200	609	524	352	240	771	659
	280 MD	2	362	278	525	440	-	-	-	-
	280 SGU	4	-	-	-	-	425	280	1109	964
	280 MGU	4	-	-	-	-	399	254	1131	986
	315 L	2	122	42	698	619	-	-	-	-
	315 LD	2	16	0	662	595	-	-	-	-
	315 SU	2	161	81	673	593	-	-	-	-
	315 MU	2	136	56	687	608	-	-	-	-
	315 SUR	4	-	-	-	-	392	247	1127	983
	315 MUR	4	-	-	-	-	342	198	1158	1014
	315 LUS	2	323	179	1171	1027	-	-	-	-
PLSES/PLS	315 LG/MGU	2; 4	60	0	498	444	682	518	1011	848
	315 VLG	2; 4	30	-	878	-	257	-	1385	-
	315 VLGU	4	-	-	-	-	183	-	1425	-
	355 L/LA/LB	2; 4	600	-	1396	-	427	-	1893	-
	400 L/LA/LB	4	-	-	-	-	632	-	2570	-

IMfinity® 3-phase induction motors - High efficiency & Premium efficiency

IP23 Aluminium or Steel frame

Construction

Radial loads

STANDARD FITTING ARRANGEMENT

Permissible radial load on main shaft extension with a bearing life L_{10h} of 25,000 hours.

FR: Radial Force

X: Distance with respect to the shaft shoulder

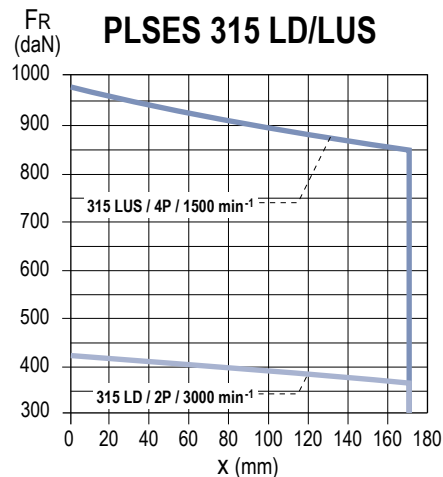
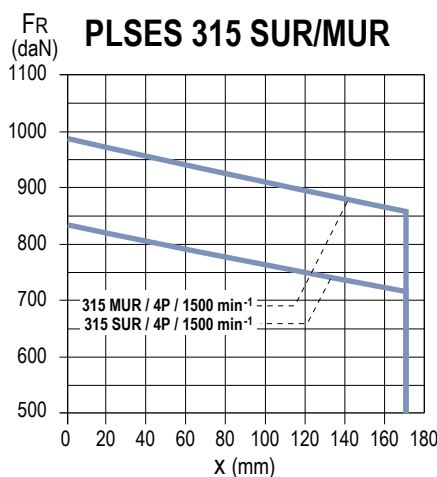
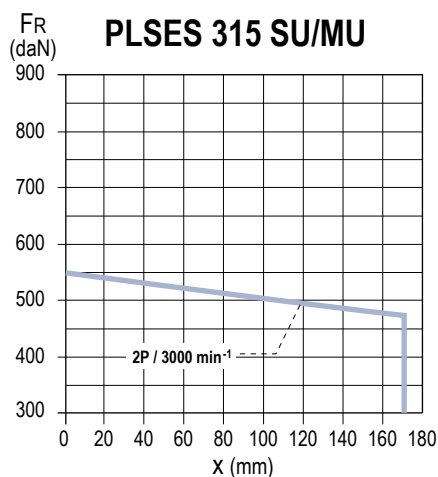
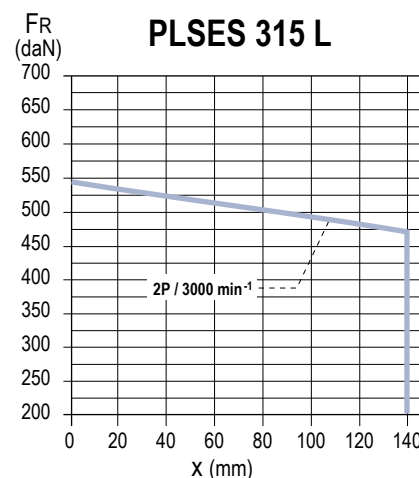
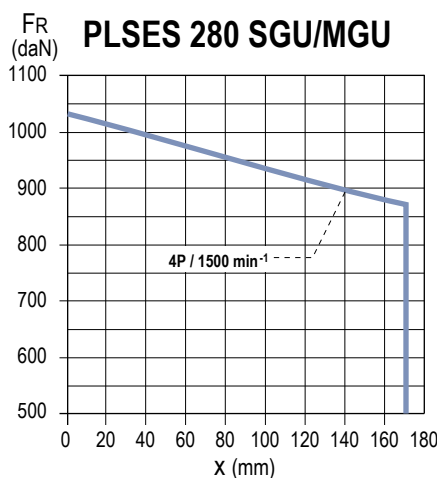
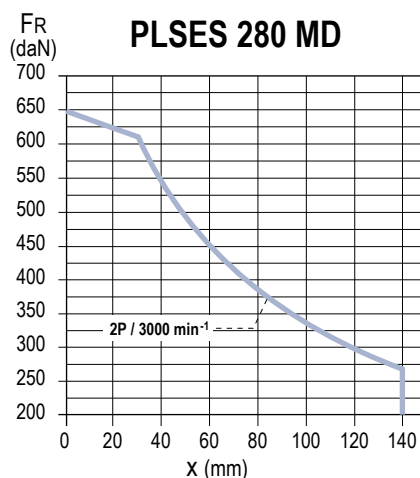
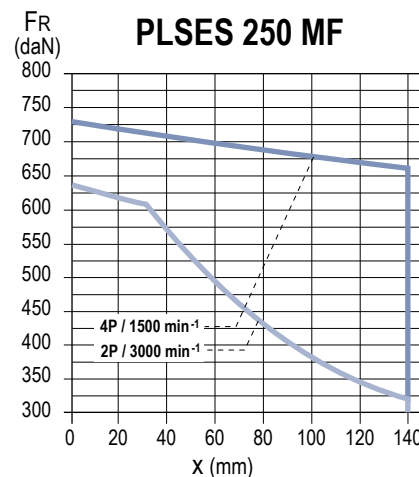
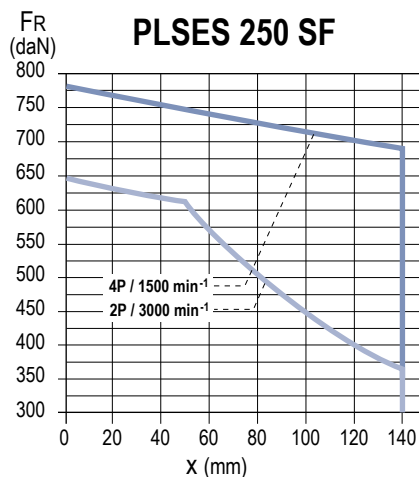
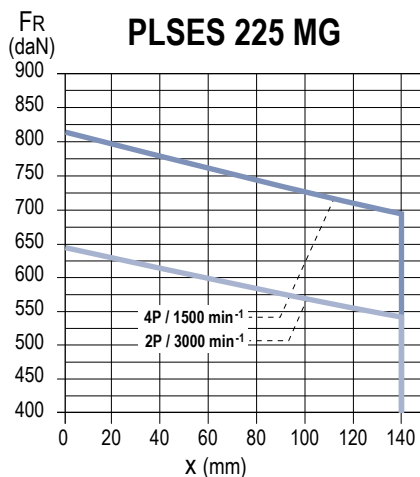

IP23 DRIP-PROOF MOTORS

IMfinity® 3-phase induction motors - High efficiency & Premium efficiency

IP23 Aluminium or Steel frame

Construction

Radial loads

STANDARD FITTING ARRANGEMENT

Permissible radial load on main shaft extension with a bearing life L_{10h} of 25,000 hours.

FR: Radial Force

X: Distance with respect to the shaft shoulder

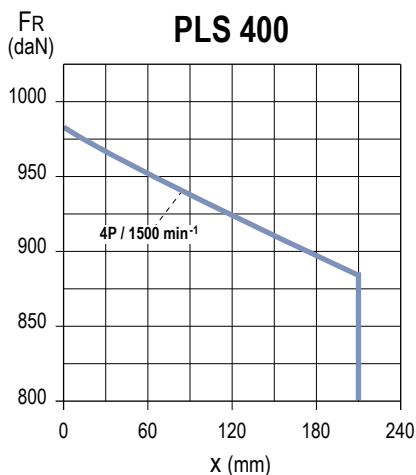
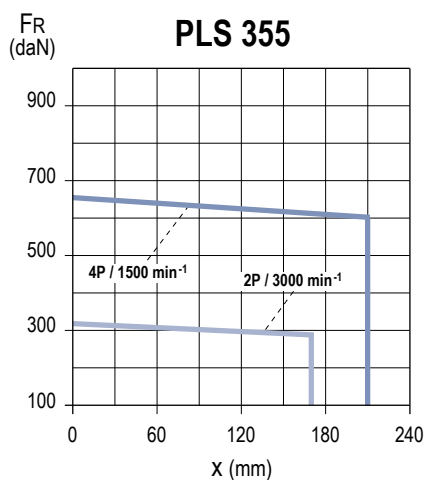
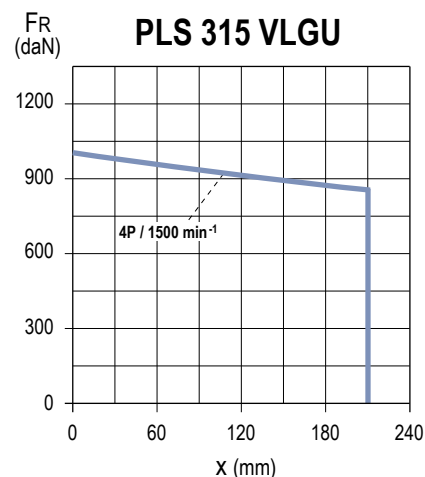
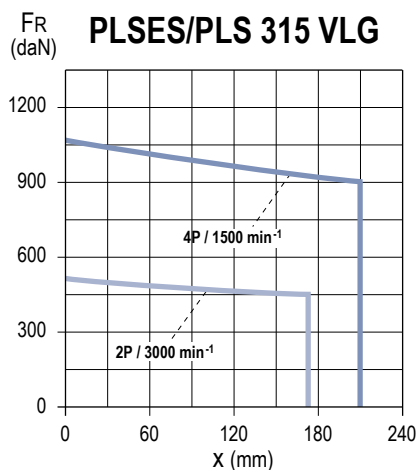
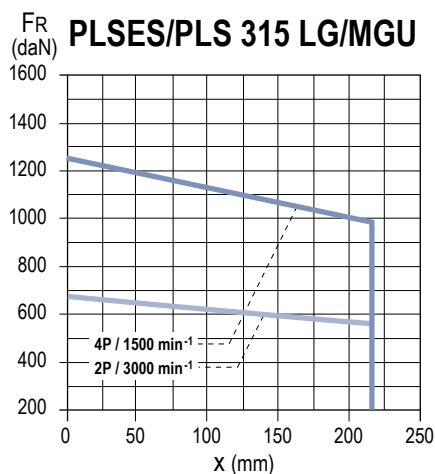

IMfinity® 3-phase induction motors - High efficiency & Premium efficiency IP23 Aluminium or Steel frame Construction

Radial loads

SPECIAL FITTING ARRANGEMENT

Type of drive end roller bearings

Series	Type	No. of poles	Non drive end bearing (N.D.E.)	Drive end bearing (D.E.)
PLSES	225 MG	4	6314 C3	NU 317
	250 SF			
	250 MF			
	280 MD			
	280 SGU	4	6316 C3	NU 320
	280 MGU			
	315 SUR			
	315 MUR			
	315 LUS			
	315 L			
315 LD	4	6317 C3	NU 316	
315 LG/MGU			NU 219	
315 VLG/VLGU			NU 322	
315 LA/LB			NU 322	
PLSES/PLS	355 LA/LB	4	6324 C3	NU 324
	400 LA/LB	4	6328 C3	NU 328

IMfinity® 3-phase induction motors - High efficiency & Premium efficiency

IP23 Aluminium or Steel frame

Construction

Radial loads

SPECIAL FITTING ARRANGEMENT

Permissible radial load on main shaft extension with a bearing life L_{10h} of 25,000 hours.

FR: Radial Force

X: Distance with respect to the shaft shoulder

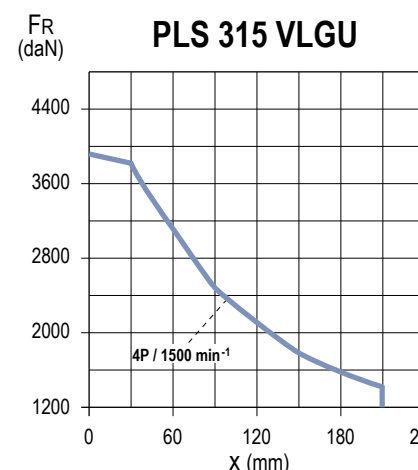
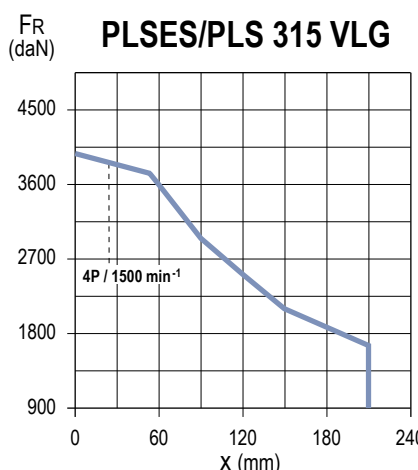
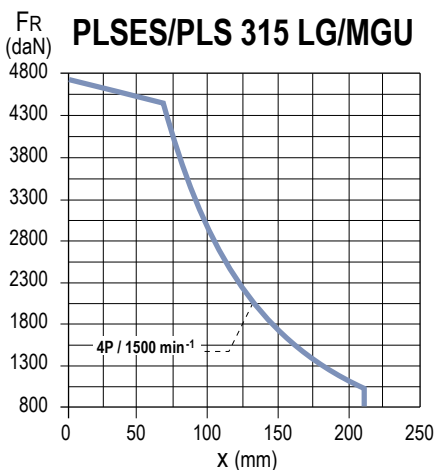
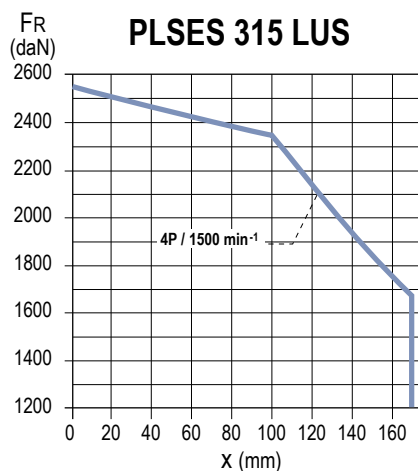
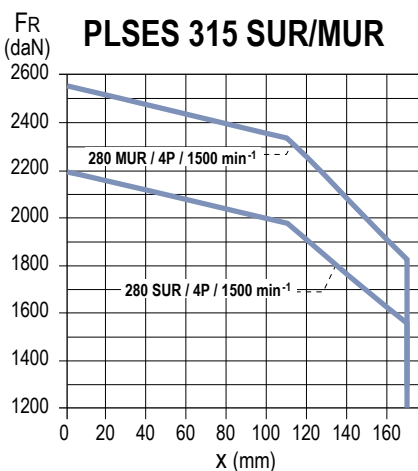
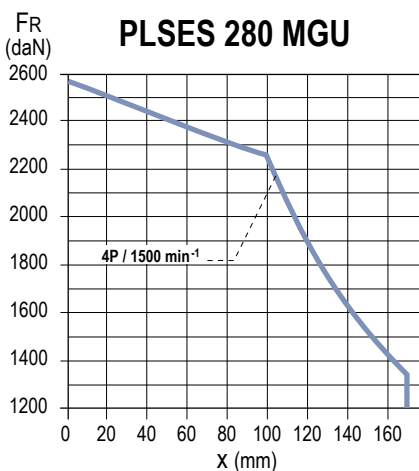
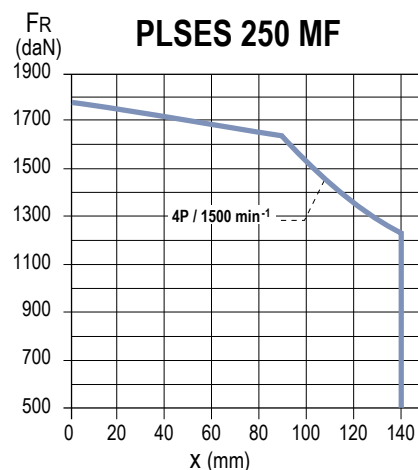
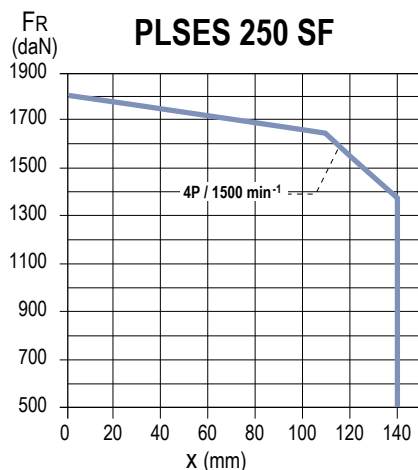
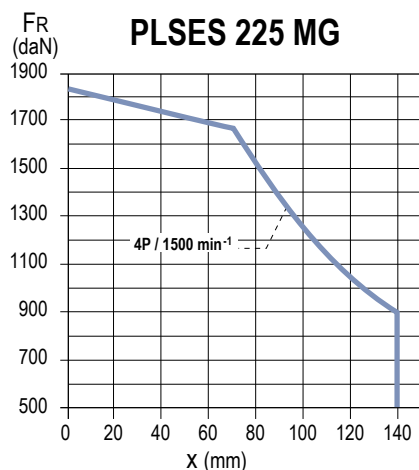

IP23 DRIP-PROOF MOTORS

IMfinity® 3-phase induction motors - High efficiency & Premium efficiency IP23 Aluminium or Steel frame Construction

Radial loads

SPECIAL FITTING ARRANGEMENT

Permissible radial load on main shaft extension with a bearing life L_{10h} of 25,000 hours.

FR: Radial Force

X: Distance with respect to the shaft shoulder

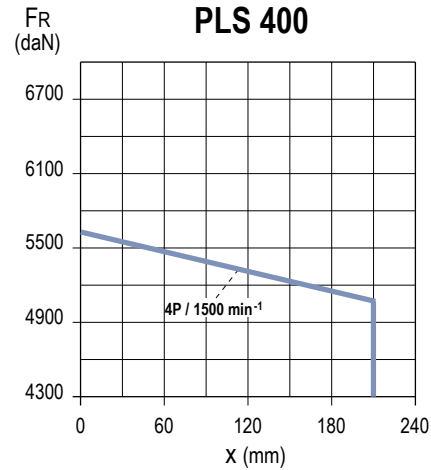
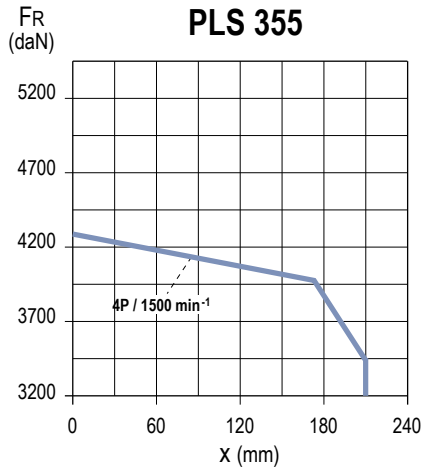

IMfinity® 3-phase induction motors - High efficiency & Premium efficiency IP23 Aluminium or Steel frame

Optional features

Mechanical options

MODIFIED FLANGES

Motor type \ Flange type	(FF) Flange mounted							
	FF 300	FF 350	FF 400	FF 500	FF 600	FF 740	FF 940	FF 1080
PLSES 225 MG			◆	●				
PLSES 250 SP/MP/MF				◆	●			
PLSES 280 MD/MG				◆	●			
PLSES 315 S/SUR/L/LD/M/MUR/LUS					◆	●		
PLSES/PLS 315 LG/MGU/VLG/VLGU					◆	●		
PLS 355 LA/LB						◆	●	
PLS 400 LA/LB							●	◆

● Standard ◆ Adaptable without shaft modification

Mechanical and electrical options

MOTORS WITH FORCED VENTILATION

The integration of high-efficiency motors within a process often requires accessories to make operation easier:

- Forced ventilation for motors used at high or low speeds.

Notes:

- Without forced ventilation, there is a possibility of overspeed with optional class B balancing.
- The motor temperature is monitored by sensors built into the windings.

MOTORS WITH SPACE HEATERS

Type	Power (W)
PLSES 225 to 280	84
PLSES/PLS 315	100
PLS 355/400	200

The space heaters use 200/240 V, single phase, 50 or 60 Hz.

IMfinity® 3-phase induction motors - High efficiency & Premium efficiency

IP23 Aluminium or Steel frame

Installation and maintenance

Position of the lifting rings

LIFTING THE MOTOR ONLY (not coupled to the machine)

The regulations stipulate that over 25 kg, suitable handling equipment must be used.

All our motors are fitted with grab handles, making them easier to handle without risk. A diagram of the sling hoisting method appears below with the required dimensions.

To prevent any damage to the motor during handling (for example: switching the motor from horizontal to vertical), it is essential to follow these instructions.

HORIZONTAL POSITION

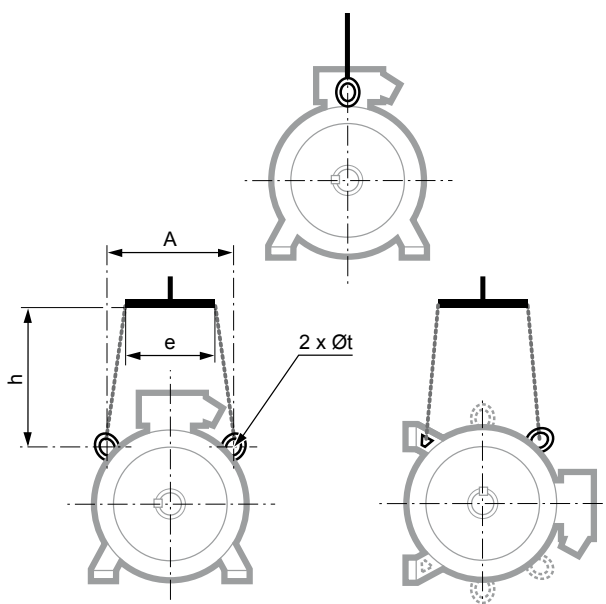

Type	Horizontal position			
	A	e min.	h min.	Øt
PLSES 225 MG	310	300	300	30
PLSES 250 MF/SF	310	300	300	30
PLSES 280 MD/MGU/SGU	310	300	300	30
PLSES 315 SUR/MUR/L/LD/LUS	385	380	500	30
PLSES/PLS 315 LG/MGU/VLG/VLGU	450	750	550	48

VERTICAL POSITION

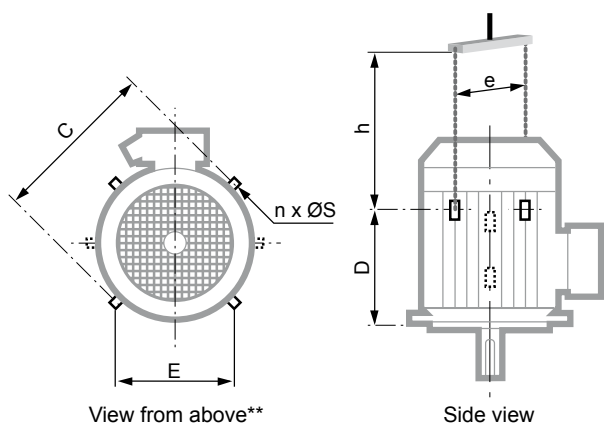

Type	Vertical position					
	C	E	n**	ØS	e min.*	h min.
PLSES 225 MG	450	310	2	14	450	490
PLSES 250 MF/SF	450	310	4	30	450	490
PLSES 280 MD/MGU/SGU	450	310	4	30	450	490
PLSES 315 SUR/MUR/L/LD/LUS	500	385	4	30	500	500
PLSES/PLS 315 LG/MGU/VLG/VLGU	750	450	4	48	750	450

* If the motor is fitted with a drip cover, allow an additional 50 to 100 mm to avoid damaging it when the load is swung.

** If $n = 2$, the lifting rings form an angle of 90° with respect to the axis of the terminal box. If $n = 4$, this angle becomes 45° .

Notes

IMfinity® 3-phase induction motors - High efficiency & Premium efficiency Environment

Special environments

Certain industries and processes are particularly harsh for electric motors.

To satisfy the demands of applications in harsh operating conditions, Leroy-Somer, thanks to its long experience in all types of application and feedback from users and service centres, has developed solutions suitable for the operational requirements.

MACHINING APPLICATIONS

Constraint: harshness of cutting oils.

Solution: motor with a “machine tools” finish for motors with aluminium frame.

Reinforced seal in the shaftway:

- sealant on the NDE and DE spigots
- NDE and DE seals with modified double lips



Mechanical adaptation for better long-term resistance:

- aluminium terminal box
- drain holes at the bottom
- “machine tools” identification on the nameplate
- fan cover with anticorrosion coating
- optional drip cover according to the mounting position

Reinforced seal on the connection:

- brass cable gland with concentric tightening
- terminal box seal, modified body/cover
- terminal box seal, modified base/cover

Ranges of proposed motors:

- frame size 80 to 132 mm
- power rating between 0.25 and 11 kW



CHEMICALS, PETROCHEMICALS, IRON & STEEL INDUSTRY, PAPER MILLS, SUGAR FACTORIES, CEMENT WORKS, ETC

Constraint: corrosive environment and harsh use.



Solution: motor with “Corrobloc” finish for cast iron motors.

- dielectric and anti-corrosion protection of the stator (coil end turns) and rotor
- stainless steel nameplate
- stainless steel screws
- cast iron terminal box body and cover
- terminal box cover with captive screws
- brass cable gland
- paint system IIIa (C4M corrosivity category in accordance with ISO 12944-2)



Ranges of proposed motors:

- frame size 90 to 450 mm
- power rating between 0.75 and 700 kW



Special environments

MERCHANT NAVY APPLICATIONS

ONBOARD INDUSTRIAL APPLICATIONS

- air compressors
- refrigeration compressors
- pumps
- fans
- conveyors



Constraint: saline corrosion, harsh use, operational safety, conformance with classification body specifications according to type of use.

Solution: motors that allow any type of mechanical and electrical protection as required.



Motors for “Marine” application conform to the specifications of the IACS classification bodies (LR, RINA, BV, DNV, ABS, GL, etc): high ambient temperature, overload, increased tolerance with regard to rated voltage and frequency, overspeed, etc).

ELECTRIC PROPULSION

- main propulsion
- auxiliary propulsion (bow thruster unit).



Constraint: reduced weight and dimensions, silent operation, high specific output power, low starting current, high efficiency, conformance with classification body specifications according to type of use.

Solution: IP23 air-cooled motors with air/water exchangers, water-cooled motors with double housing. Magnetic circuits able to cope with a high number of starts.



IMfinity® 3-phase induction motors - High efficiency & Premium efficiency

Energy regulations worldwide

Regulations in the main countries

Several countries have already implemented energy regulations relating to electric motors. Others are in the process of drafting them.

Some regulations require products to be registered with the local authorities prior to release onto the market. In these cases, the market is monitored before starting to use the products, unlike the EU where the member states are allowed to organise monitoring on their own territory.























Most countries which impose product registration before release onto the market also usually require special product marking.

For Europe, there is no specific label. Only the CE mark indicates that the product conforms to all the relevant directives.

The table below summarises the main regulations existing worldwide.

These regulations are constantly changing and regular updates are necessary.

Leroy-Somer has registered some of its motor ranges in the majority of countries mentioned, depending on market requirements.

Country	Standard	Regulation	Approval mark if necessary	Registration compulsory	Power	No. of poles	2013	2014	2015	2016	2017
 EUROPE	IEC60034-2-1 IEC60034-30	ErP 640/2009			0,75kW- 375kW	2, 4, 6					
 SWISS	IEC60034-2-1 IEC60034-30	ordonnance 730.01			0,75kW- 375kW	2, 4, 6	IE2	IE2	IE3	IE3	IE3
 TURKEY	IEC60034-2-1 IEC60034-30	SGM 2012/2			0,75kW- 375kW	2, 4, 6					
 ISRAEL	IEC60034-2-1 IEC60034-30	SI 5289			0,75kW- 185kW	2,4,6,8					
 USA	MG1 112-11 IEEE 112-B	EISA 10CFR431.31		X	1 HP- 200HP	2, 4, 6					
 CANADA	C747-09 C390-10	LC 1992 ch.36		X	1 HP- 200HP	2, 4, 6	IE3	IE3	IE3	IE3	IE3
 MEXICO	MG1 112-11 IEEE 112-B	CONUEE NOM-016-ENER		X	0,75 kW- 375kW	2, 4, 6					
 BRAZIL	NBR 17094-3 NBR 5383-1	INMETRO		X	0,75kW- 185kW	2,4,6,8	IE2	IE2	IE2	IE2	IE2
 INDIA	IS 12615				0,75kW- 375kW	2, 4, 6	IE2	IE3	IE3	IE3	IE3
 South KOREA	KSC IEC60034-2-1	KEMCO		X	0,75kW- 200kW	2,4,6,8	IE2	IE2	IE3	IE3	IE3
 CHINA	GB18613-2012	CER		X	0,75kW- 375kW	2, 4, 6	IE2	IE2	IE3	IE3	IE3
 AUSTRALIA	IEC60034-2-1 IEEE 112-B	E3		X	0,75kW- 185kW	2,4,6,8	IE2	IE2	IE3	IE3	IE3
 NEW ZEALAND	IEC60034-2-1 IEEE 112-B	EECA		X	0,75kW- 185kW	2,4,6,8	IE2	IE2	IE3	IE3	IE3
 JAPAN	JIS C4034-2-1 JIS C4034-30				0,20kW- 160kW	2, 4, 6	IE2	IE2	IE3	IE3	IE3
 TAIWAN	CNS 14400				0,75kW- 200kW	2, 4, 6	IE2	IE2	IE3	IE3	IE3

voluntary **MANDATORY**

Calculating the efficiency of an induction motor

MACHINE EFFICIENCY

Efficiency is the ratio between the output power (needed to drive a machine) and the power absorbed (power consumed). This value is therefore necessarily less than 1. The difference between the output power and the power absorbed consists of the electrical machine losses. 85% efficiency therefore means there are 15% losses.

Direct measurement method

With the direct method, efficiency is calculated using mechanical (torque C and speed Ω) and electrical (power absorbed P_{abs}) measurements. If the measuring tools are specified (use of a torquemeter), this method has the advantage of being relatively easy. However, it does not provide any information about machine performance and the origins of the potential losses.

$$\eta = \frac{P_u}{P_{abs}} \text{ where } P_u = C \Omega$$

Indirect measurement methods

These methods determine efficiency by determining the machine losses. Conventionally, a distinction is made between three types of losses: joule losses (stator P_{js} and rotor P_{jr}), iron losses (P_f) and mechanical losses (P_m) which are relatively easy to measure. Miscellaneous losses which are more difficult to determine, called additional losses, are added to these losses.

In standard IEC 60034-2 dated 1972 and applicable until November 2010, the method for calculating additional losses uses a fixed percentage of 0.5% of the power absorbed.

$$\eta = \frac{P_{abs} - P_{js} - P_{jr} - P_f - P_m - P_{sup}}{P_{abs}} \text{ where } P_{sup} = 0.5\% P_{abs}$$

Additional losses come from a variety of sources: surface losses, busbar currents, high-frequency losses, losses linked to leakage flux, etc. They are specific to each machine and contribute to reducing efficiency but they are very complex to calculate from a quantitative point of view.

In the new standard IEC 60034-2-1 dated September 2007, these additional losses must be measured precisely. This is a similar approach to that taken by the North American (IEEE112-B) and Canadian (CSA390) standards, which deduct the additional losses from a thermally-stable on-load curve.

The residual losses are calculated at each load point: 25%, 50%, 75%, 100%, 115% and 125%:

$$P_{res} = P_{abs} - P_{js} - P_{jr} - P_f - P_m - P_u \text{ where } P_u = C \Omega$$

The straight line is drawn by approximating the curve points as closely as possible. The measure is acceptable if a correlation coefficient of 0.95 or higher can be ensured.

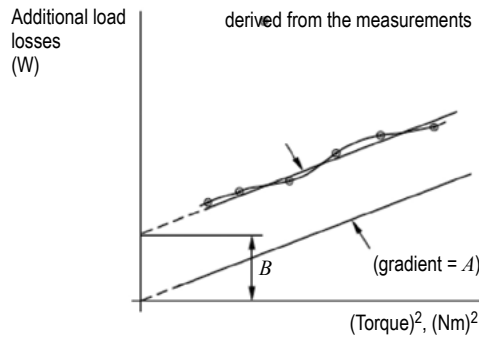

The line to 0 gives the additional losses at the nominal point, ie. at 100% load.

From then on, the usual equation gives the efficiency:

$$\eta = \frac{P_{abs} - P_{js} - P_{jr} - P_f - P_m - P_{sup}}{P_{abs}}$$

Note that with this method, the Joule losses must be corrected according to the temperature and the iron losses corrected according to the resistive voltage dip in the stator.

IMfinity® 3-phase induction motors - High efficiency & Premium efficiency

Appendix

Units of measurement and standard formulae

ELECTRICITY AND ELECTROMAGNETISM

Parameters				Unit		Units and expressions not recommended
French name	English name	Symbol	Definition	SI	Non SI, but accepted	Conversion
Fréquence Période	Frequency	f		Hz (hertz)		
Courant électrique (intensité de)	Electric current	I		A (ampere)		
Potentiel électrique Tension Force électromotrice	Electric potential Voltage Electromotive force	V U E		V (volt)		
Déphasage	Phase angle	φ		rad	° degree	
Facteur de puissance	Power factor	$\cos \varphi$				
Réactance Résistance Impédance	Reactance Resistance Impedance	X R Z		Ω (ohm)		j is defined as $j^2 = -1$ ω rotational frequency = $2\pi \cdot f$
Inductance propre (self)	Self inductance	L		H (henry)		
Capacité	Capacitance	C		F (farad)		
Charge électrique, Quantité d'électricité	Quantity of electricity	Q		C (coulomb)	A.h 1 A.h = 3600 C	
Résistivité	Resistivity	ρ		$\Omega \cdot m$		Ω/m
Conductance	Conductance	G		S (siemens)		$1/\Omega = 1\text{ S}$
Nombre de tours, (spires) de l'enroulement Nombre de phases Nombre de paires de pôles	N° of turns (coil) N° of phases N° of pairs of poles	N m p				
Champ magnétique	Magnetic field	H		A/m		
Différence de potentiel magnétique Force magnétomotrice Solénation, courant totalisé	Magnetic potential difference Magnetomotive force	Um F, Fm H		A		The unit AT (ampere-turns) is incorrect because it treats "turn" as a physical unit
Induction magnétique, Densité de flux magnétique	Magnetic induction Magnetic flux density	B		T (tesla) = Wb/m ²		(gauss) 1 G = 10 ⁻⁴ T
Flux magnétique, Flux d'induction magnétique	Magnetic flux	Φ		Wb (weber)		(maxwell) 1 max = 10 ⁻⁸ Wb
Potentiel vecteur magnétique	Magnetic vector potential	A		Wb/m		
Perméabilité d'un milieu Perméabilité du vide	Permeability Permeability of vacuum	$\mu = \mu_0 \mu_r$ μ_0		H/m		
Permittivité	Permittivity	$\epsilon = \epsilon_0 \epsilon_r$		F/m		

IMfinity® 3-phase induction motors - High efficiency & Premium efficiency

Appendix

Units of measurement and standard formulae

THERMODYNAMICS

Parameters				Unit		Units and expressions not recommended
French name	English name	Symbol	Definition	SI	Non SI, but accepted	Conversion
Température Thermodynamique	Temperature Thermodynamic	T		K (kelvin)	temperature Celsius, t , °C $T = t + 273.15$	°C: Degree Celsius t_C : Temp. in °C t_F : Temp. in °F f temperature Fahrenheit °F
Écart de température	Temperature rise	ΔT		K	°C	1°C = 1 K
Densité de flux thermique	Heat flux density	q, φ		W/m ²		
Conductivité thermique	Thermal conductivity	λ		W/m.K		
Coefficient de transmission thermique global	Total heat transmission coefficient	K		W/m ² .K		
Capacité thermique	Heat capacity	C		J/K		
Capacité thermique massique	Specific heat capacity	c		J/kg.K		
Energie interne	Internal energy	U		J		

NOISE AND VIBRATION

Parameters				Unit		Units and expressions not recommended
French name	English name	Symbol	Definition	SI	Non SI, but accepted	Conversion
Niveau de puissance acoustique	Sound power level	L_w	$L_w = 10 \lg(P/P_o)$ ($P_o = 10^{-12} W$)	dB (decibel)		\lg logarithm to base 10 $\lg 10 = 1$
Niveau de pression acoustique	Sound pressure level	L_p	$L_p = 20 \lg(P/P_o)$ ($P_o = 2 \times 10^{-5} Pa$)	dB		

DIMENSIONS

Parameters				Unit		Units and expressions not recommended
French name	English name	Symbol	Definition	SI	Non SI, but accepted	Conversion
Angle (angle plan)	Angle (plane angle)	$\alpha, \beta, \gamma, \varphi$		rad	degree: ° minute: ' second: ''	180° = π rad = 3.14 rad
Longueur Largeur Hauteur Rayon Longueur curviligne	Length Breadth Height Radius	l b h r s		m (metres)	micrometre	cm, dm, dam, hm 1 inch = 1" = 25.4 mm 1 foot = 1' = 304.8 mm μ m micron μ angström: Å = 0.10 nm
Aire, superficie	Area	A, S		m ²		1 square inch = 6.45 10 ⁻⁴ m ²
Volume	Volume	V		m ³	litre: l liter: L	UK gallon = 4.546 10 ⁻³ m ³ US gallon = 3.785 10 ⁻³ m ³

IMfinity® 3-phase induction motors - High efficiency & Premium efficiency

Appendix

Units of measurement and standard formulae

MECHANICS

Parameters				Unit		Units and expressions not recommended
French name	English name	Symbol	Definition	SI	Non SI, but accepted	Conversion
Temps Intervalle de temps, durée Période (durée d'un cycle)	Time	t		s (second)	minute: min hour: h day: d	Symbols ' and " are reserved for angles minute not written as mn
	Period (periodic time)	T				
Vitesse angulaire Pulsation	Angular velocity Circular frequency	ω	$\omega = \frac{d\varphi}{dt}$	rad/s		
Accélération angulaire	Angular acceleration	α	$\alpha = \frac{d\omega}{dt}$	rad/s ²		
Vitesse Célérité	Speed Velocity	u, v, w, c	$v = \frac{ds}{dt}$	m/s	1 km/h = 0.277,778 m/s 1 m/min = 0.0166 m/s	
Accélération	Acceleration	a	$a = \frac{dv}{dt}$			
Accélération de la pesanteur	Acceleration of free fall	$g = 9.81 \text{ m/s}^2$	<i>in Paris</i>			
Vitesse de rotation	Revolution per minute	N		s ⁻¹	min ⁻¹	tr/mn, RPM, TM, etc
Masse	Mass	m		kg (kilogram)	tonne: t 1 t = 1,000 kg	kilo, kgs, KG, etc 1 pound: 1 lb = 0.4536 kg
Masse volumique	Mass density	ρ	$\frac{dm}{dV}$	kg/m ³		
Masse linéique	Linear density	ρ_e	$\frac{dm}{dL}$	kg/m		
Masse surfacique	Surface mass	ρ_A	$\frac{dm}{dS}$	kg/m ²		
Quantité de mouvement	Momentum	P	$p = m.v$	kg. m/s		
Moment d'inertie	Moment of inertia	J, I	$I = \sum m.r^2$	kg.m ²		$J = \frac{MD^2}{4}$ kg.m ² pound per square foot = 1 lb.ft ² = 42.1 x 10 ⁻³ kg.m ²
Force Poids	Force Weight	F G	$G = m.g$	N (newton)		kgf = kgp = 9.81 N pound force = lbf = 4.448 N
Moment d'une force	Moment of force, Torque	M T	$M = F.r$	N.m		mdaN, mkg, m.N 1 mkg = 9.81 N.m 1 ft.lbf = 1.356 N.m 1 in.lbf = 0.113 N.m
Pression	Pressure	p	$p = \frac{F}{S} = \frac{F}{A}$	Pa (pascal)	bar 1 bar = 10 ⁵ Pa	1 kgf/cm ² = 0.981 bar 1 psi = 6894 N/m ² = 6894 Pa 1 psi = 0.06894 bar 1 atm = 1.013 x 10 ⁵ Pa
Contrainte normale Contrainte tangentielle, Cission	Normal stress Shear stress	σ τ		Pa Leroy-Somer use the MPa = 10 ⁶ Pa		kg/mm ² , 1 daN/mm ² = 10 MPa psi = pound per square inch 1 psi = 6894 Pa
Facteur de frottement	Friction coefficient	μ				incorrectly = coefficient friction f
Travail Énergie Énergie potentielle Énergie cinétique Quantité de chaleur	Work Energy Potential energy Kinetic energy Quantity of heat	W E Ep Ek Q	$W = F.l$	J (joule)	Wh = 3600 J (watt-hour)	1 N.m = 1 W.s = 1 J 1 kgm = 9.81 J (calorie) 1 cal = 4.18 J 1 Btu = 1055 J (British thermal unit)
Puissance	Power	P	$P = \frac{W}{t}$			W (watt)
Débit volumique	Volumetric flow	q_v	$q_v = \frac{dV}{dt}$	m ³ /s		
Rendement	Efficiency	η		< 1		%
Viscosité dynamique	Dynamic viscosity	η, μ		Pa.s		poise, 1 P = 0.1 Pa.s
Viscosité cinématique	Kinematic viscosity	ν	$\nu = \frac{\eta}{\rho}$	m ² /s		stokes, 1 St = 10 ⁻⁴ m ² /s

IMfinity® 3-phase induction motors - High efficiency & Premium efficiency

Appendix

Unit conversions

Unit	MKSA (IS international system)	AGMA (US system)
Length	1 m = 3.2808 ft 1 mm = 0.03937 in	1 ft = 0.3048 m 1 in = 25.4 mm
Weight	1 kg = 2.2046 lb	1 lb = 0.4536 kg
Torque	1 Nm = 0.7376 lb.ft 1 N.m = 141.6 oz.in	1 lb.ft = 1.356 N.m 1 oz.in = 0.00706 N.m
Force	1 N = 0.2248 lb	1 lb = 4.448 N
Moment of inertia	1 kg.m ² = 23.73 lb.ft ²	1 lb.ft ² = 0.04214 kg.m ²
Power	1 kW = 1.341 HP	1 HP = 0.746 kW
Pressure	1 kPa = 0.14505 psi	1 psi = 6.894 kPa
Magnetic flux	1 T = 1 Wb / m ² = 6.452 10 ⁴ line / in ²	1 line / in ² = 1.550 10 ⁻⁵ Wb / m ²
Magnetic losses	1 W / kg = 0.4536 W / lb	1 W / lb = 2.204 W / kg

Multiples and sub-multiples		
Factor by which the unit is multiplied	Prefix to be placed before the unit name	Symbol to be placed before that of the unit
10 ¹⁸ or 1,000,000,000,000,000,000	exa	E
10 ¹⁵ or 1,000,000,000,000,000	peta	P
10 ¹² or 1,000,000,000,000	tera	T
10 ⁹ or 1,000,000,000	giga	G
10 ⁶ or 1,000,000	mega	M
10 ³ or 1,000	kilo	k
10 ² or 100	hecto	h
10 ¹ or 10	deca	da
10 ⁻¹ or 0.1	deci	d
10 ⁻² or 0.01	centi	c
10 ⁻³ or 0.001	milli	m
10 ⁻⁶ or 0.000,001	micro	μ
10 ⁻⁹ or 0.000,000,001	nano	n
10 ⁻¹² or 0.000,000,000,001	pico	p
10 ⁻¹⁵ or 0.000,000,000,000,001	femto	f
10 ⁻¹⁸ or 0.000,000,000,000,000,001	atto	a

IMfinity® 3-phase induction motors - High efficiency & Premium efficiency

Appendix

Standard formulae used in electrical engineering

MECHANICAL FORMULAE

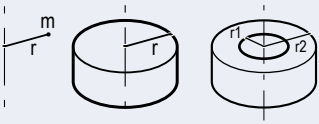
Title	Formula	Unit	Definitions / Notes
Force	$F = m \cdot \gamma$	F in N m in kg γ in m/s^2	A force F is the product of a mass m by an acceleration γ
Weight	$G = m \cdot g$	G in N m in kg $g = 9.81 \text{ m/s}^2$	
Moment	$M = F \cdot r$	M in N.m F in N r in m	The torque M of a force in relation to an axis is the product of that force multiplied by the distance r of the point of application of F in relation to the axis.
Power	- rotating $P = M \cdot \omega$ - linear $P = F \cdot V$	P in W M in N.m ω in rad/s P in W F in N V in m/s	Power P is the quantity of work yielded per unit of time $\omega = 2\pi N/60$ where N is the speed of rotation in min^{-1} $V =$ linear velocity
Acceleration time	$t = J \cdot \frac{\omega}{M_a}$	t in s J in kg.m^2 ω in rad/s M_a in Nm	J is the moment of inertia of the system M_a is the moment of acceleration Note: All the calculations refer to a single rotational speed ω where the inertias at speed ω' are corrected to speed ω by the following calculation: $J_\omega = J_{\omega'} \cdot \left(\frac{\omega'}{\omega}\right)^2$
Moment of inertia Centre of gravity	$J = m \cdot r^2$		
Solid cylinder around its axis	$J = m \cdot \frac{r^2}{2}$	J in kg.m^2 m in kg r in m	
Hollow cylinder around its axis	$J = m \cdot \frac{r_1^2 + r_2^2}{2}$		
Inertia of a mass in linear motion	$J = m \cdot \left(\frac{v}{\omega}\right)^2$	J in kg.m^2 m in kg v in m/s ω in rad/s	The moment of inertia of a mass in linear motion transformed to a rotating motion.

IMfinity® 3-phase induction motors - High efficiency & Premium efficiency

Appendix

Standard formulae used in electrical engineering

ELECTRICAL FORMULAE

Title	Formula	Unit	Definitions / Notes
Accelerating torque	$M_a = \frac{M_D + 2M_A + 2M_M + M_N - M_r}{6}$ <p>General formula:</p> $M_a = \frac{1}{N_N} \int_0^{N_N} (M_{mot} - M_r) dN$	Nm	Moment of acceleration M_a is the difference between the motor torque M_{mot} (estimated), and the resistive torque M_r . (M_D , M_A , M_M , M_N , see curve below) N = instantaneous speed N_N = rated speed
Power required by the machine	$P = \frac{M \cdot \omega}{\eta_A}$	P in W M in N.m ω in rad/s η_A no units	η_A expresses the efficiency of the driven machine. M is the torque required by the driven machine.
Power drawn by the 3-phase motor	$P = \sqrt{3} \cdot U \cdot I \cdot \cos \varphi$	P in W U in V I in A	φ phase angle by which the current lags or leads the voltage. U armature voltage. I line current.
Reactive power drawn by the motor	$Q = \sqrt{3} \cdot U \cdot I \cdot \sin \varphi$	Q in VAR	
Reactive power supplied by a bank of capacitors	$Q = \sqrt{3} \cdot U^2 \cdot C \cdot \omega$	U in V C in μ F ω in rad/s	U = voltage at the capacitor terminals C = capacitor capacitance ω = rotational frequency of supply phases ($\omega = 2\pi f$)
Apparent power	$S = \sqrt{3} \cdot U \cdot I$ $S = \sqrt{P^2 + Q^2}$	S in VA	
Power supplied by the 3-phase motor	$P = \sqrt{3} \cdot U \cdot I \cdot \cos \varphi \cdot \eta$		η expresses motor efficiency at the point of operation under consideration.
Slip	$g = \frac{N_S - N}{N_S}$		Slip is the difference between the actual motor speed N and the synchronous speed N_S
Synchronous speed	$N_S = \frac{120 \cdot f}{p}$	N_S in min^{-1} f in Hz	p = number of poles f = frequency of the power supply

Parameters	Symbol	Unit	Torque and current curve as a function of speed
Starting current	I_D	A	
Rated current	I_N		
No-load current	I_O		
Starting torque*	M_D	Nm	
Run up torque	M_A		
Breakdown torque	M_M		
Rated torque	M_N		
Rated speed	N_N	min^{-1}	
Synchronous speed	N_S		

* Torque is the usual term for expressing the moment of a force.

IMfinity® 3-phase induction motors - High efficiency & Premium efficiency

Appendix

Tolerance on main performance parameters

TOLERANCES ON ELECTROMECHANICAL CHARACTERISTICS

IEC 60034-1 specifies standard tolerances for electromechanical characteristics.

Parameters	Tolerances
Efficiency	<ul style="list-style-type: none"> machines P ≤ 150 kW machines P > 150 kW
Cos φ	- 1/6 (1 - cos φ) (min 0.02 - max 0.07)
Slip	<ul style="list-style-type: none"> machines P < 1 kW machines P ≥ 1 kW
Locked rotor torque	- 15%, + 25% of rated torque
Starting current	+ 20%
Run-up torque	- 15% of rated torque
Maximum torque	-10% of rated torque > 1.5 M _N
Moment of inertia	± 10%
Noise	+ 3 dB (A)
Vibration	+ 10% of the guaranteed class

Note: IEC 60034-1 - does not specify tolerances for current
- the tolerance is ± 10% in NEMA-MG1

TOLERANCES AND ADJUSTMENTS

The standard tolerances shown below are applicable to the drawing dimensions given in our catalogues. They comply fully with the requirements of IEC standard 60072-1.

Characteristics	Tolerances
Frame size H ≤ 250 ≥ 280	0, - 0.5 mm 0, - 1 mm
Diameter Ø of the shaft extension: - 11 to 28 mm - 32 to 48 mm - 55 mm and over	j6 k6 m6
Diameter N of flange spigots	j6 up to FF 500, js6 for FF 600 and over
Key width	h9
Width of drive shaft keyway (normal keying)	N9
Key depth: - square section - rectangular section	h9 h11
① Eccentricity of shaft in flanged motors (standard class) - diameter > 10 up to 18 mm - diameter > 18 up to 30 mm - diameter > 30 up to 50 mm - diameter > 50 up to 80 mm - diameter > 80 up to 120 mm	0.035 mm 0.040 mm 0.050 mm 0.060 mm 0.070 mm
② Concentricity of spigot diameter and ③ perpendicularity of mating surface of flange in relation to shaft (standard class) Flange (FF) or Faceplate (FT): - F 55 to F 115 - F 130 to F 265 - FF 300 to FF 500 - FF 600 to FF 740 - FF 940 to FF 1080	0.08 mm 0.10 mm 0.125 mm 0.16 mm 0.20 mm

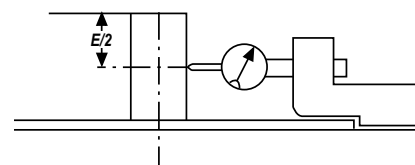

① Eccentricity of shaft in flanged motors

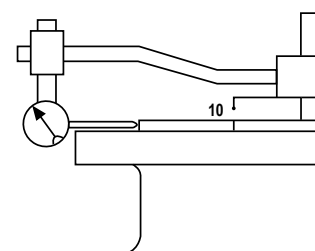

② Concentricity of spigot diameter

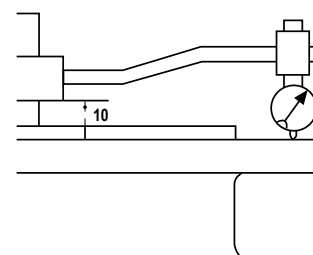

③ Perpendicularity of mating surface of flange in relation to shaft

IMfinity® 3-phase induction motors - High efficiency & Premium efficiency Appendix

Configurator



The Leroy-Somer configurator can be used to choose the most suitable motor and provides the technical specifications and corresponding drawings.

- Help with product selection
- Print-outs of technical specifications
- Print-outs of 2D and 3D CAD files
- The equivalent of 400 catalogues in 16 languages

Register online at:
<http://www.emersonindustrial.com/EN-EN/LEROY-SOMER-MOTORS-DRIVES/PRODUCTS/CONFIGURATOR/>

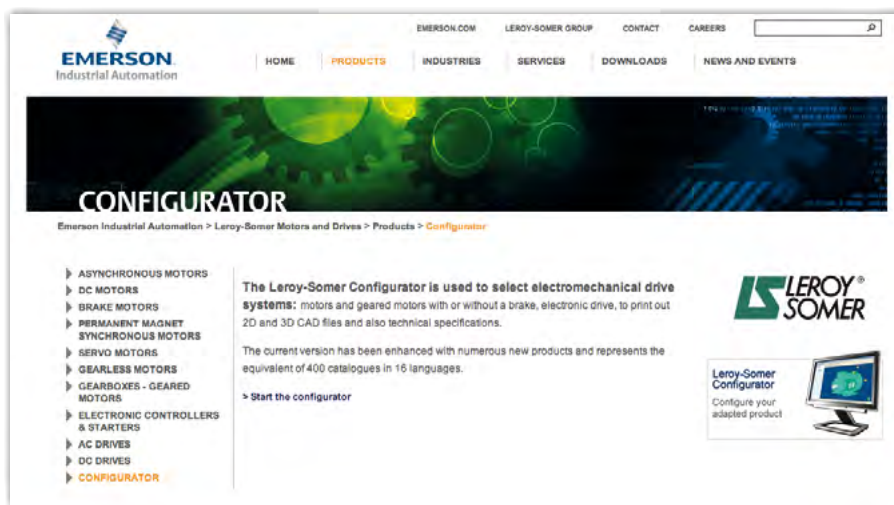

Product availability

Express Availability - Induction motors

LSES - IMfinity®
 High-efficiency three-phase motors with aluminium frame
 Class IE3

AVAILABILITY TIMES EX WORKS (FRANCE), IN WORKING DAYS

Model	D	D+1	D+2	D+5	D+10
LSES 112	Available	Available	Available	Available	Available
LSES 132	Available	Available	Available	Available	Available
LSES 160	Available	Available	Available	Available	Available
LSES 180	Available	Available	Available	Available	Available
LSES 200	Available	Available	Available	Available	Available
LSES 225	Available	Available	Available	Available	Available
LSES 250	Available	Available	Available	Available	Available
LSES 280	Available	Available	Available	Available	Available
LSES 315	Available	Available	Available	Available	Available
LSES 355	Available	Available	Available	Available	Available
LSES 400	Available	Available	Available	Available	Available
LSES 450	Available	Available	Available	Available	Available
LSES 500	Available	Available	Available	Available	Available
LSES 560	Available	Available	Available	Available	Available
LSES 630	Available	Available	Available	Available	Available
LSES 710	Available	Available	Available	Available	Available
LSES 800	Available	Available	Available	Available	Available
LSES 900	Available	Available	Available	Available	Available
LSES 1000	Available	Available	Available	Available	Available

230 V / 380 V / 400 V / 415 V / 50 Hz - 400 V / 60 Hz

AVAILABILITY TIMES EX WORKS (FRANCE), IN WORKING DAYS

Orders received, within the maximum quantity limit, by the factory on day D before 12:00 pm Central European Time, will have the following Availability. For products with options, availability will be that of the longest lead-time item i.e. the product or its options. If the order is received after 12:00 pm 1 working day on the mentioned availability will be added. The maximum quantity is per line of order. Above this maximum quantity, please consult your Sales Office.

D D+1 D+2 D+5 D+10 Please consult

Being able both to respond to urgent requests and adhere to promised customer lead times calls for a powerful logistics system.

The availability of motors is ensured by the network of approved partners and Leroy-Somer central services all working together.

The selection data in the "Express Availability Drive systems" catalogue specify for each family in the form of a colour code and according to the quantities per order, the product delivery time.

Please consult Leroy-Somer.

EMERSON. CONSIDER IT SOLVED.™

www.emersonindustrial.com



© Emerson 2014. The information contained in this brochure is for guidance only and does not form part of any contract. The accuracy cannot be guaranteed as Emerson have an ongoing process of development and reserve the right to change the specification of their products without notice.

Control Techniques Limited. Registered Office: The Gro, Newtown, Powys SY16 3BE. Registered in England and Wales. Company Reg. No. 01236886

Moteurs Leroy-Somer SAS. Headquarters: Bd Marcellin Leroy, CS 10015, 16915 Angoulême Cedex 9, France. Share Capital: 65 800 512 €, RCS Angoulême 338 567 258.

5147 en - 2015.04 / d